

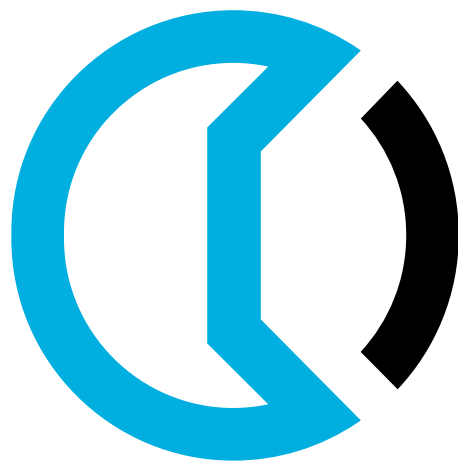

GENERAL CATALOGUE



CEMBRE

www.cembre.com

CEMBRE AT A GLANCE

INNOVATION IS IN OUR DNA



211

Patents and filled applications

71

Registered trademarks



MAIN MANUFACTURING SITE, ITALY



60,000

m² of space dedicated to offices, factories, laboratories

121,000
m² of site

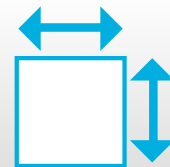

OUR PRODUCT CODES



21,500

different product codes sold each year

21,800

product codes are available for immediate dispatch



AUTOMATED WAREHOUSE



60,000

bins capacity

10,000

order lines per working day



are registered trademarks of Cembre S.p.A.

 **CEMBRE**

 **C e m b r e**

Crimpstar

ZETApiù

ZETAblock

ZETAmini

SICURclips

MAXIblock

*spiral*block

MAXIbrass

Quality and Innovation: our priorities



Certified Quality Management System



Certified Environmental Management System



Certified Occupational Health & Safety Management System



“It is the aim of CEMBRE S.p.A. and all its employees to pursue the satisfaction of their customers through the fulfilling of their needs by meeting their legitimate expectations.”

To achieve this goal, CEMBRE places the following principles at the very heart of its work:

- highest quality product and services
- continuously research and innovative solutions.
- safeguarding the environment and protecting the health and safety of workers and users of its products
- respect and promote the values set out in the Company's Code of Ethics
- ensure strict fulfillment of statutory, national and international laws and regulations

The Company's Management System, certified in accordance with ISO 9001 : 2015 quality standards, ISO 14001 : 2015 for environmental protection and ISO 45001 : 2018 standard for the protection of the health and safety of workers, **are the tools used to translate the principles of company policy into corporate objectives and to monitor their fulfilment.**



All Cembre products comply with Directive 2011/65/EU of the European Parliament and Council dated 8 June 2011 (and subsequent amendments)

Index

ELECTRICAL CONNECTORS

symbol description.....	4
PVC INSULATED CRIMP TERMINALS.....	6
FEMALE DISCONNECT TERMINALS.....	8
MALE DISCONNECT TERMINALS.....	8
MALE/FEMALE.....	8
BULLET AND SOCKET.....	8
BUTT AND PARALLEL CONNECTORS.....	9
BUTT CONNECTORS.....	9
CLOSE END CONNECTORS.....	9
HALOGEN FREE INSULATED TERMINALS.....	10
INSULATED CHAIN TERMINALS.....	12
REINFORCED PA 6.6 INSULATED TERMINALS.....	14
REINFORCED DISCONNECT TERMINALS.....	16
FEMALE CONNECTORS.....	16
MALE CONNECTORS.....	17
MALE TABS.....	17
CONNECTOR SLEEVES.....	17
PA6 INSULATED END SLEEVES.....	18
"TWIN" PA6 INSULATED END SLEEVES.....	19
POLYPROPYLENE INSULATED CHAIN END SLEEVES.....	20
UNINSULATED END SLEEVES.....	21
CRIMPING CONNECTORS ACCORDING TO DIN 46234.....	26
COPPER TUBE CRIMPING LUGS.....	28
RING TONGUE TERMINALS WITH CONTAINED PALM.....	30
COPPER TUBE CRIMPING LUGS.....	31
COPPER TUBE CRIMPING LUGS ANGLED 90°.....	32
COPPER TUBE CRIMPING LUGS.....	33
COPPER TUBE CRIMPING LUGS ANGLED 315° and 345°.....	35
HEAVY DUTY COPPER TUBE TERMINALS.....	36
THROUGH CONNECTORS.....	38
PARALLEL CONNECTORS.....	38
POLYAMIDE PA6.6 INSULATED COPPER TUBE LUGS.....	39
POLYAMIDE PA6.6 INSULATED FORK TERMINALS.....	41
UNINSULATED FORK TERMINALS.....	41
POLYAMIDE PA6.6 INSULATED PIN TERMINALS.....	42
UNINSULATED PIN CONNECTORS.....	42
UNINSULATED ROUND PIN CONNECTORS.....	42
UNINSULATED ROUND PIN CONNECTORS ANGLED 45°.....	43
COPPER TUBE LUGS 4-ESI FIXING.....	43
COPPER TUBE CRIMPING LUGS ACCORDING TO DIN 46235.....	44
CRIMPING THROUGH CONNECTORS ACCORDING TO DIN 46267 T.1.....	45
COPPER TUBE CRIMPING LUGS.....	46
CRIMPING THROUGH CONNECTORS.....	47
COPPER TUBE CRIMPING LUGS ACCORDING TO NFC 20-130.....	48
COPPER TUBE CRIMPING LUGS ANGLED 90°.....	49
CRIMPING THROUGH CONNECTORS.....	49
COLOUR CODED COPPER CRIMPING LUGS.....	50
COLOUR CODED SPLICES.....	54
SLEEVE CONNECTORS.....	55
H CLAMPS.....	56
TWIN CABLE TERMINAL LUGS FOR ROUND CONDUCTORS.....	56
MECHANICAL FIXING LUGS.....	57
CABLE CLAMPS.....	57
MEDIUM VOLTAGE COPPER TERMINALS.....	58
MEDIUM VOLTAGE STALK CONNECTORS.....	60
MEDIUM VOLTAGE COPPER THROUGH CONNECTORS.....	61
ALUMINIUM TERMINALS.....	62
THROUGH CONNECTORS.....	63
REDUCER THROUGH CONNECTORS.....	63
ALUMINIUM TERMINALS.....	64
ALUMINIUM THROUGH CONNECTORS.....	65
BIMETALLIC CONNECTORS.....	66
MECHANICAL LUGS.....	67
MECHANICAL LUGS WITH SYMMETRICAL PALM.....	68
MECHANICAL SPLICES.....	68

TERMINAL BLOCKS, FLEXIBLE BUSBAR, BRAIDS AND DISTRIBUTION BLOCKS

symbol description.....	70
example applications.....	71
SINGLE POLE TERMINAL BLOCKS.....	72
CONNECTING CAPACITY OF TERMINAL BLOCKS.....	74
POWER DISTRIBUTION BLOCKS.....	76
CONNECTING CAPACITY OF POWER DISTRIBUTION BLOCKS.....	77
ONE WAY TERMINAL BLOCKS.....	78
TERMINAL BLOCK TYPE EKL.....	79
TERMINAL BLOCK TYPE ZS.....	79
UNIPOLAR DISTRIBUTION BLOCKS.....	80
BIPOLAR DISTRIBUTION BLOCKS.....	80
TETRAPOLAR DISTRIBUTION BLOCKS.....	81
ACCESSORIES.....	81
INSULATED FLEXIBLE BUSBAR.....	82
FLEXIBLE BRAIDS.....	84

CABLE GLANDS AND ACCESSORIES

symbol description.....	86
range overview.....	87
MAXIBLOCK CABLE GLANDS.....	88
SPIRALBLOCK CABLE GLANDS.....	92
MAXIBLOCK ATEX CABLE GLANDS.....	93
COMPRESSION CABLE GLANDS.....	94
POLYSTYRENE CABLE GLANDS.....	95
MAXIBRASS CABLE GLANDS.....	96
MAXIBRASS ATEX CABLE GLANDS.....	100
EMC CABLE GLANDS.....	100
COMPRESSION CABLE GLANDS.....	101
MAXINOX CABLE GLANDS.....	102
LOCKNUTS WITH COLLAR.....	104
LOCKNUTS WITHOUT COLLAR.....	105
LOCKNUTS.....	106
EMC LOCKNUTS.....	107
MAXINOX LOCKNUTS.....	107
INTERNAL PLUGS FOR CABLE GLANDS.....	108
MULTI-ENTRY SEALS FOR CABLE GLANDS.....	109
ENTRY THREAD ADAPTERS.....	110
ACCESSORIES.....	113
SEALING RINGS.....	114
ENTRY PLUGS.....	117
ENTRY BUSHES.....	118
ENTRY PLUGS.....	119
ENTRY BUSHES.....	119
RUTASEAL GROMMETS.....	120
MODULAR RETAINING CLIPS.....	120

MECHANICAL AND PNEUMATIC TOOLS

symbol description.....	122
MECHANICAL TOOLS CRIMPSTAR® RANGE.....	124
MECHANICAL TOOLS ND® RANGE.....	132
MECHANICAL TOOLS ZKE RANGE.....	133
MECHANICAL TOOLS HP4 RANGE.....	134
MECHANICAL TOOL HWE1.....	136
MECHANICAL TOOL MLR J1.....	136
MECHANICAL TOOL IDT.....	137
MECHANICAL TOOLS TN RANGE.....	138
MECHANICAL TOOLS TND RANGE.....	140
MECHANICAL TOOLS TNH RANGE.....	141
MECHANICAL TOOLS TNF RANGE.....	142
CABLE CUTTERS KT RANGE.....	143
PROFESSIONAL SCISSORS SC RANGE.....	145
CABLE STRIPPING TOOLS HB RANGE.....	146
WIRE STRIPPERS HB RANGE.....	147
HAND TOOLS.....	147
FRAME-TYPE HOLE PUNCHING TOOL.....	148

BENCH PRESS TOOLS

BENCH PRESS TOOLS.....	150
ELECTRO-PNEUMATIC BENCH PRESS.....	152
PNEUMATIC CRIMPING TOOLS.....	153
BENCH PRESS.....	154

HYDRAULIC TOOLS AND HEADS

symbol description.....	156
HYDRAULIC CRIMPING TOOLS.....	158
HYDRAULIC PRESSEHEADS.....	160
HYDRAULIC CUTTING TOOLS.....	174
HYDRAULIC CUTTING HEADS.....	174
FRAME-TYPE HOLE PUNCHING HEAD.....	183
PIERCING HEADS.....	183
PULLER-TYPE HOLE PUNCHING TOOLS.....	184
HOLE PUNCHING KIT.....	184
PULLER-TYPE HOLE PUNCHING HEAD.....	185
NUT SPLITTING HEADS.....	186

CORDLESS HYDRAULIC TOOLS

symbol description.....	188
18.0 V - 5.2 Ah CORDLESS TOOL FEATURES.....	190
18.0 V - 2.0 Ah CORDLESS TOOL FEATURES.....	191
18.0 V CORDLESS HYDRAULIC CRIMPING TOOLS.....	192
18.0 V CORDLESS HYDRAULIC CUTTING TOOLS.....	213
18.0 V CORDLESS HYDRAULIC FRAME-TYPE HOLE PUNCHING TOOLS.....	219
18.0 V CORDLESS HYDRAULIC PULLER-TYPE HOLE PUNCHING TOOLS.....	221
KIT FOR HOLE PUNCHING.....	222
PUNCHING ACCESSORIES AVAILABLE.....	223
PRESSURE TEST DEVICE.....	224

HYDRAULIC PUMPS AND UNITS

HYDRAULIC PUMP.....	226
PORTABLE ELECTRO-HYDRAULIC PUMPS.....	228
PORTABLE ELECTRO-HYDRAULIC PUMPS B70M-P36 RANGE.....	230
ACCESSORIES FOR B70M-P36.....	232
HYDRAULIC UNITS.....	233
HYDRAULIC CUTTING UNITS.....	235
PORTABLE BATTERY HYDRAULIC CUTTING UNITS.....	237
ACCESSORIES FOR CORDLESS TOOLS.....	238
ACCESSORIES FOR STORAGE OF DIES.....	239
TRANSPORT ACCESSORIES.....	239
ACCESSORIES FOR NON-INSULATED HYDRAULIC PUMPS.....	240
ACCESSORIES FOR INSULATED HYDRAULIC PUMPS.....	240

MARKETLINE PRODUCTS

symbol description.....	242
CABLE TIES.....	244
ACCESSORIES.....	248
INSULATED COVERS.....	249
TERMOCOIL HEAT-SHRINKABLE TUBING.....	250
TERMOSTRIP HEAT-SHRINKABLE TUBING.....	252
TERMOBLOCK HEAT-SHRINKABLE TUBING.....	254
CAST RESIN JOINTS.....	255
MECHANICAL TOOLS.....	257
CABLE TIE TOOLS.....	258
MEASURING TAPES.....	258

DIE SELECTOR CHART

DIE SELECTOR CHART.....	260
DIE SELECTOR CHART FOR DEEP STEPPED INDENTING WITH CONTAINING DIES.....	265
DIE SELECTOR CHART.....	267
MUT DIES CROSS REFERENCE CHART.....	272
RHU600 DIES CROSS REFERENCE CHART.....	273
RHU1000 DIES CROSS REFERENCE CHART.....	274

APPENDIX

























Type/Code Cross-Reference chart.....	276
Comparison of AWG, MCM and Metric conductor cross sections.....	292
IEC 60228 : 2004 - 11 conductor tables.....	293
System of denomination of harmonised cables according to CENELEC HD 361.....	296
UL and VDE marking of cable glands.....	297
Ingress protection (IP) rating according to EN 60529 - CEI 70-1.....	298
Flammability test for products and materials.....	300
Recommended torque settings for cable glands.....	301
New Hand Tool Range.....	302
Identification & Labelling.....	303
General terms and conditions of sale.....	304

ELECTRICAL CONNECTORS



symbol description

electrical connectors

	Insulation sleeve in Polyvinylchloride		Aluminium connectors of of a purity equal to or greater than 99,5%.
	Insulation sleeve in Polycarbonate		Aldrey connectors
	Insulation sleeve in Nylon PA6.6		Zinc Plated Steel connectors
	Insulation sleeve in Polyethylene High Density		Internal surface is filled with special grease so as to avoid oxidation of the connector
	Heat shrinkable		Connector provided with central stop
	Insulation sleeve form to allow easy "introduction" of the conductor		Colour coded connectors
	Manufactured from electrolytic Copper strip with a purity greater than 99.9%		Facilitated introduction of the conductor
	Manufactured from Brass strip with a purity greater than 99.9%		Inspection hole for checking the correct introduction of the conductor
	Manufactured from electrolytic Copper tube with a purity greater than 99.9%		Contained palm connectors
	Manufactured from electrolytic Copper wire with a purity greater than 99.9%		Annealed material
	Brazed seam		Electrolytically tin plated to avoid oxidation; min 3µm
	Brass connectors		Lugs angled
	Bimetallic connectors, Aluminium and Copper.		Zinc Plated Steel screws

symbol description

electrical connectors



Zinc Plated Steel nuts



Operating temperature range



Hexagonal crimp



Degree of protection



Radial crimp



UL LISTING Marking valid in USA & CANADA



Indent crimp



UL LISTING Marking valid in USA & CANADA



Deep indent crimp



In accordance with DIN 46235



Oval crimp



Meets the requirements for fire testing of materials and components for trains EN 45545-2:2015



Trapezium crimp



Halogen free



Circular crimp



Semicircular crimp



Indent crimp



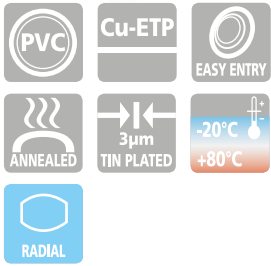

The unique funnel shaped PVC sleeve guarantees total insertion of the conductor strands into the terminal barrel, creating a secure and reliable, electrical and mechanical connection. The internal surface of the barrel is rifled to improve contact with conductor strands when crimped and to increase tensile strength. The "F" range of terminals offers a wide selection of rings, forks, pins and blades, designed to meet the ever changing end user requirements.

The PVC insulation, is a self extinguishing thermoplastic material class V0 (UL 94). The operating temperature range is -20 to +80°C (Surge +90°C). Recommended crimping tools are shown on pages 124 to 151, 192, 257.



pin terminals

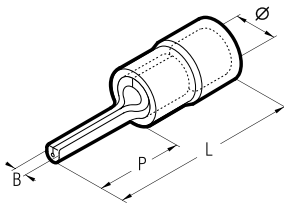

Conductor Size sqmm (AWG)	Type	Dimensions mm				Quantity Box/Bag
		Ø	B	P	L	
0,25÷1,5 (22÷16)	RF-P8	4,0	1,6	8,0	17,8	3.000/100
	RF-P10	4,0	1,6	10,0	19,8	3.000/100
	RF-P12	4,0	1,6	12,0	22,0	3.000/100
1,5÷2,5 (16÷14)	BF-P8	4,9	1,6	8,0	17,8	2.500/100
	BF-P10	4,9	1,6	10,0	19,8	2.500/100
	BF-P12	4,9	1,6	12,0	21,8	2.500/100
4÷6 (12÷10)	GF-P10	6,6	2,2	10,0	24,5	1.000/100
	GF-P12	6,6	2,2	12,0	26,7	1.000/100
	GF-P14	6,6	2,2	14,0	28,7	1.000/100

hooked blade terminals

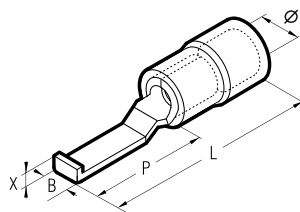

blade terminals

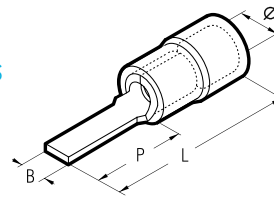

Conductor Size sqmm (AWG)	Type	Dimensions mm				Quantity Box/Bag
		Ø	B	P	L	
0,25÷1,5 (22÷16)	RF-PP12	4,0	3,0	12,8	22,8	3.000/100
	RF-PP12/1	4,0	3,0	11,3	21,3	3.000/100
	RF-PP12/19	4,0	1,9	13,2	23,2	3.000/100
	RF-PP12/23	4,0	2,3	13,2	23,2	2.500/100
	RF-PP14	4,0	3,0	14,8	24,8	2.500/100
	RF-PP16/23	4,0	2,3	17,2	27,2	2.500/100
1,5÷2,5 (16÷14)	BF-PP10	4,9	3,5	10,0	20,0	2.500/100
	BF-PP12	4,9	3,5	12,8	22,8	2.500/100
	BF-PP12/25	4,9	2,5	13,3	23,3	2.000/100
	BF-PP12/29*	4,9	2,9	13,3	23,3	2.500/100
	BF-PP16/25	4,9	2,5	17,2	27,2	2.500/100
	GF-PP12	6,6	4,0	13,3	27,4	1.000/100
4÷6 (12÷10)	GF-PP17	6,6	2,9	19,2	33,3	1.000/100

Conductor Size sqmm (AWG)	Type	Dimensions mm					Quantity Box/Bag
		Ø	B	P	L	X	
0,25÷1,5 (22÷16)	RF-PPL30*	4,0	3,0	17,5	28,3	1,7	2.500/100
	RF-PPL46*	4,0	4,6	17,5	28,3	1,7	2.500/100
1,5÷2,5 (16÷14)	BF-PPL30*	4,9	3,0	17,5	28,3	1,7	2.000/100
	BF-PPL46*	4,9	4,6	17,5	28,3	1,7	2.000/100
4÷6 (12÷10)	GF-PPL46*	6,6	4,6	17,5	32,6	1,9	1.000/100

*Not UL approved

PVC INSULATED CRIMP TERMINALS

RF BF GF

F range funnel entry - for Copper conductors



VALSTAR-V3-F



Robust plastic case with compartments, containing:

- An assortment of PVC insulated crimp terminals for conductor sizes 0,25 to 6 mm² (22÷10 AWG).
- Tool Crimpstar® HP 3.

Connectors included:

- Qty 50 terminals RF-U4
- Qty 50 terminals RF-U5
- Qty 50 terminals RF-P10
- Qty 50 terminals BF-U4
- Qty 50 terminals BF-U5
- Qty 50 terminals BF-P10
- Qty 25 terminals GF-U5
- Qty 25 terminals GF-U6
- Qty 25 terminals GF-P12
- Qty 25 connectors PL06-M
- Qty 25 connectors PL1-M

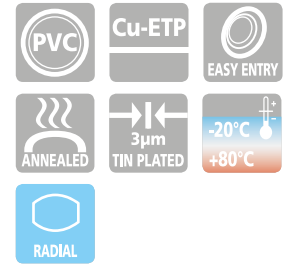

ring terminals

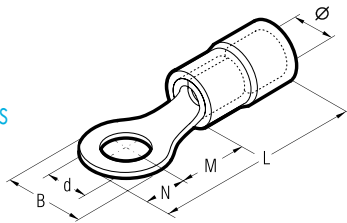

Conductor Size sqmm (AWG)	Ø Stud mm	Type	Dimensions mm						Quantity Box/Bag
			Ø	B	M	N	L	d	
0,25÷1,5 (22÷16)	4,0	2 RF-M2**	4,0	5,6	4,5	2,8	17,3	2,2	3.000/100
		3 RF-M3	4,0	5,6	4,5	2,8	17,3	3,2	3.000/100
		3,5 RF-M3.5	4,0	5,6	4,5	2,8	17,3	3,7	3.000/100
		3,5 RF-M3.5/1	4,0	6,2	7,1	3,1	20,2	3,7	3.000/100
		4 RF-M4	4,0	7,0	6,5	3,5	20,0	4,3	3.000/100
		4 RF-M4/3*	4,0	7,8	7,1	3,9	21,0	4,3	3.000/100
		5 RF-M5	4,0	7,8	7,1	3,9	21,0	5,3	2.500/100
		6 RF-M6	4,0	9,4	8,1	4,7	22,8	6,4	2.500/100
		6 RF-M6/1	4,0	12,0	10,3	6,0	26,3	6,4	2.000/100
		7 RF-M7	4,0	9,4	8,1	4,7	22,8	7,2	2.500/100
		8 RF-M8	4,0	12,0	10,3	6,0	26,3	8,4	2.000/100
		10 RF-M10	4,0	15,5	13,0	7,7	30,8	10,5	1.500/100
12 RF-M12	4,0	18,0	15,5	9,0	34,5	13,0	1.500/100		
1,5÷2,5 (16÷14)	4,9	2 BF-M2**	4,9	5,6	5,0	2,8	17,8	2,2	3.000/100
		3 BF-M3	4,9	5,6	5,0	2,8	17,8	3,2	2.500/100
		3,5 BF-M3.5	4,9	5,6	5,0	2,8	17,8	3,7	2.500/100
		3,5 BF-M3.5/1	4,9	6,2	6,5	3,1	19,6	3,7	2.500/100
		4 BF-M4	4,9	8,0	6,5	4,0	20,5	4,3	2.500/100
		5 BF-M5	4,9	8,0	7,5	4,0	21,5	5,3	2.000/100
		6 BF-M6	4,9	9,4	8,6	4,7	23,3	6,4	2.000/100
		6 BF-M6/1	4,9	12,0	10,3	6,0	26,3	6,4	2.000/100
		6 BF-M6/2**	4,9	8,4	5,4	4,2	19,6	6,4	2.500/100
		7 BF-M7	4,9	10,0	7,8	5,0	22,8	7,2	2.000/100
		8 BF-M8	4,9	12,0	10,3	6,0	26,3	8,4	1.500/100
		10 BF-M10	4,9	15,5	13,0	7,7	30,8	10,5	1.500/100
12 BF-M12	4,9	18	15,5	9,0	34,5	13,0	1.000/100		
4÷6 (12÷10)	6,6	3 GF-M3	6,6	8,0	8,1	4,0	26,2	3,2	1.000/100
		3,5 GF-M3.5	6,6	8,0	8,1	4,0	26,2	3,7	1.000/100
		4 GF-M4	6,6	9,0	8,1	4,5	26,7	4,3	1.000/100
		5 GF-M5	6,6	9,0	8,1	4,5	26,7	5,3	1.000/100
		6 GF-M6	6,6	11,0	11,1	5,5	30,7	6,4	1.000/100
		6 GF-M6/1	6,6	11,0	8,1	5,5	27,7	6,4	1.000/100
		7 GF-M7	6,6	11,0	11,1	5,5	30,7	7,2	1.000/100
		8 GF-M8	6,6	13,6	12,1	6,8	33,0	8,4	800/100
		8 GF-M8/1**	6,6	11,0	8,1	5,5	27,7	8,4	1.000/100
		10 GF-M10	6,6	13,6	12,1	6,8	33,0	10,5	800/100
		10 GF-M10/1	6,6	15,5	13,8	7,7	35,7	10,5	800/100
		12 GF-M12	6,6	19,0	15,1	9,5	38,7	13,0	500/100
		14 GF-M14	6,6	21,0	16,1	10,5	40,7	15,0	500/100
		16 GF-M16	6,6	24,0	17,1	12,0	43,2	17,0	500/100

fork/spade terminals

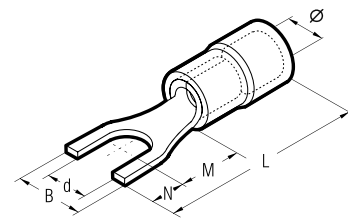

Conductor Size sqmm (AWG)	Ø Stud mm	Type	Dimensions mm						Quantity Box/Bag
			Ø	B	M	N	L	d	
0,25÷1,5 (22÷16)	4,0	3 RF-U3	4,0	5,5	5,5	4,0	19,5	3,2	3.000/100
		3,5 RF-U3.5	4,0	6,0	6,5	3,8	20,3	3,7	3.000/100
		3,5 RF-U3.5/1	4,0	7,2	6,5	3,8	20,3	3,7	3.000/100
		3,5 RF-U3.5/2*	4,0	6,4	6,5	3,8	20,3	3,7	3.000/100
		4 RF-U4	4,0	6,5	7,5	3,7	21,2	4,3	3.000/100
		4 RF-U4/1	4,0	8,5	7,5	3,7	21,2	4,3	3.000/100
		4 RF-U4/2	4,0	7,5	7,5	3,7	21,2	4,3	3.000/100
		5 RF-U5	4,0	8,5	7,5	3,7	21,2	5,3	2.500/100
		5 RF-U5/1**	4,0	9,4	7,5	3,7	21,2	5,3	3.000/100
		6 RF-U6	4,0	9,4	8,1	4,7	22,8	6,4	2.000/100
		6 RF-U6/1	4,0	12,0	9,2	7,1	26,3	6,4	2.000/100
		8 RF-U8	4,0	14,0	10,0	6,3	26,3	8,4	2.000/100
10 RF-U10	4,0	17,5	13,0	7,7	30,8	10,5	1.500/100		
12 RF-U12	4,0	20,0	15,5	9,0	34,5	13,0	1.500/100		
1,5÷2,5 (16÷14)	4,9	3 BF-U3	4,9	5,5	5,5	4,0	19,5	3,2	2.500/100
		3,5 BF-U3.5	4,9	6,4	6,5	3,8	20,3	3,7	2.500/100
		3,5 BF-U3.5/1*	4,9	7,2	6,5	3,8	20,3	3,7	3.000/100
		4 BF-U4	4,9	6,5	7,5	3,7	21,2	4,3	2.500/100
		4 BF-U4/1	4,9	8,5	7,5	3,7	21,2	4,3	2.000/100
		4 BF-U4/2	4,9	7,5	7,5	3,7	21,2	4,3	2.000/100
		5 BF-U5	4,9	8,5	7,5	3,7	21,2	5,3	2.000/100
		5 BF-U5/2*	4,9	12,0	11,3	5,0	26,3	5,3	1.500/100
		6 BF-U6	4,9	9,4	8,1	4,7	22,8	6,4	2.000/100
		6 BF-U6/1	4,9	12,0	9,2	7,1	26,3	6,4	2.000/100
		8 BF-U8	4,9	14,0	10,0	6,3	26,3	8,4	1.500/100
		10 BF-U10	4,9	17,5	13,0	7,7	30,8	10,5	1.000/100
12 BF-U12	4,9	20,0	15,5	9,0	34,5	13,0	1.000/100		
4÷6 (12÷10)	6,6	3,5 GF-U3.5	6,6	7,5	8,5	3,9	26,5	3,7	1.000/100
		4 GF-U4	6,6	7,5	8,0	4,4	26,5	4,3	1.000/100
		5 GF-U5	6,6	9,5	8,0	4,4	26,5	5,3	1.000/100
		6 GF-U6	6,6	10,0	11,0	5,5	30,6	6,4	1.000/100
		8 GF-U8	6,6	13,5	12,0	8,0	34,1	8,4	1.000/100
		10 GF-U10	6,6	15,5	13,0	8,0	35,1	10,5	1.000/100
		10 GF-U10/1	6,6	17,5	13,8	7,7	35,7	10,5	1.000/100
		12 GF-U12	6,6	21,0	15,1	9,5	38,7	13,0	500/100
14 GF-U14	6,6	23,0	16,1	10,5	40,7	15,0	500/100		
16 GF-U16	6,6	26,0	17,1	11,5	42,7	17,0	500/100		

*Not UL approved *Made to order

RF-F BF-F GF-F



* Material: Polycarbonate type PC10500AC certified EN45545-2

FEMALE DISCONNECT TERMINALS

for Copper conductors

Recommended crimping tools are shown on pages 124 to 151, 192, 257.

Polycarbonate* insulated terminals partially reinforced with Copper sleeve

Conductor Size sqmm (AWG)	Type	Tab Size mm	Quantity Box/Bag
0,25÷1,5 (22÷16)	RF-F305	2,8 x 0,5	3.000/100
	RF-F308*	2,8 x 0,8	3.000/100
	RF-F405	4,8 x 0,5	2.500/100
	RF-F408	4,8 x 0,8	2.500/100
1,5÷2,5 (16÷14)	RF-F608	6,35 x 0,8	2.500/100
	BF-F405	4,8 x 0,5	2.500/100
	BF-F408	4,8 x 0,8	2.500/100
4÷6 (12÷10)	BF-F608	6,35 x 0,8	1.500/100
	GF-F608	6,35 x 0,8	1.000/100



Polycarbonate* fully insulated terminals partially reinforced with Copper sleeve

Conductor Size sqmm (AWG)	Type	Tab Size mm	Quantity Box/Bag
0,25÷1,5 (22÷16)	RF-F305P	2,8 x 0,5	2.000/100
	RF-F308P*	2,8 x 0,8	2.000/100
	RF-F405P	4,8 x 0,5	1.500/100
	RF-F408P	4,8 x 0,8	1.500/100
1,5÷2,5 (16÷14)	RF-F608P	6,35 x 0,8	1.000/100
	BF-F405P	4,8 x 0,5	1.500/100
	BF-F408P	4,8 x 0,8	1.500/100
4÷6 (12÷10)	BF-F608P	6,35 x 0,8	1.000/100
	GF-F608P	6,35 x 0,8	800/100

RF-M BF-M GF-M

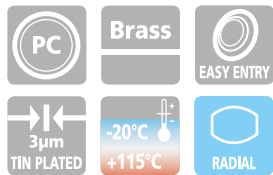

* Material: Polycarbonate type PC10500AC certified EN45545-2

MALE DISCONNECT TERMINALS

for Copper conductors

Recommended crimping tools are shown on pages 124 to 151, 192, 257.

Polycarbonate* insulated terminals partially reinforced with Copper sleeve

Conductor Size sqmm (AWG)	Type	Tab Size mm	Quantity Box/Bag
0,25÷1,5 (22÷16)	RF-M608	6,35 x 0,8	3.000/100
1,5÷2,5 (16÷14)	BF-M608	6,35 x 0,8	2.000/100
4÷6 (12÷10)	GF-M608	6,35 x 0,8	1.000/100



Polycarbonate* fully insulated terminals partially reinforced with Copper sleeve

Conductor Size sqmm (AWG)	Type	Tab Size mm	Quantity Box/Bag
0,25÷1,5 (22÷16)	RF-M608P	6,35 x 0,8	1.000/100
1,5÷2,5 (16÷14)	BF-M608P	6,35 x 0,8	800/100

RF-FM BF-FM RF-B BF-B



* Material: Polycarbonate type PC10500AC certified EN45545-2

MALE/FEMALE

for Copper conductors

Recommended crimping tools are shown on pages 124 to 151, 192, 257.

Polycarbonate* insulated terminals partially reinforced with Copper sleeve

Conductor Size sqmm (AWG)	Type	Tab Size mm	Quantity Box/Bag
0,25÷1,5 (22÷16)	RF-FM608	6,35 x 0,8	1.000/100
1,5÷2,5 (16÷14)	BF-FM608	6,35 x 0,8	1.000/100

BULLET AND SOCKET

for Copper conductors

Polycarbonate* insulated terminals partially reinforced with Copper sleeve

Conductor Size sqmm (AWG)	Type	Ø mm	Quantity Box/Bag
0,25÷1,5 (22÷16)	RF-BM4*	4,0	2.500/100
	RF-BF4*	3,95	800/100
1,5÷2,5 (16÷14)	BF-BM5*	5,0	2.000/100
	BF-BF5*	4,95	800/100



*Not UL approved

BUTT AND PARALLEL CONNECTORS

for Copper conductors



butt connectors

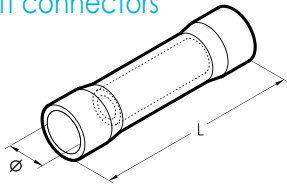

parallel connectors

Recommended crimping tools are shown on pages 124 to 151, 192, 257.

PVC insulated

Conductor Size sqmm (AWG)	Type	ø mm	L mm	Quantity Box/Bag
0,25÷0,5 (24÷20)	PL01-M*	3,0	25,0	3.000/100
0,25÷1,5 (22÷16)	PL03-M	4,0	25,0	1.000/100
1,5÷2,5 (16÷14)	PL06-M	5,0	25,0	1.500/100
4÷6 (12÷10)	PL1-M	6,5	32,0	500/100
0,25÷1,5 (22÷16)	PL03-P*	4,0	20,0	3.000/100
1,5÷2,5 (16÷14)	PL06-P*	5,0	16,0	2.000/100

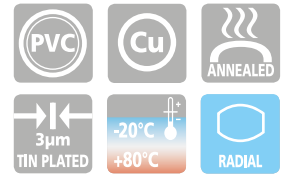

BUTT CONNECTORS

for Copper conductors

Recommended crimping tools are shown on pages 124 to 151, 192, 257.

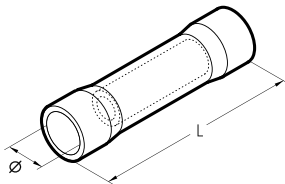

Polyamide PA6.6 insulated

Conductor Size sqmm (AWG)	Type	ø mm	L mm	Quantity Box/Bag
0,25÷1,5 (22÷16)	NL03-M	4,0	25,0	1.000/100
1,5÷2,5 (16÷14)	NL06-M	5,4	25,5	1.500/100
4÷6 (12÷10)	NL1-M	7,6	32,0	500/100
10 (8÷7)	NL2-M	8,0	43,0	500/100
16 (6÷5)	NL3-M	9,2	44,0	400/100

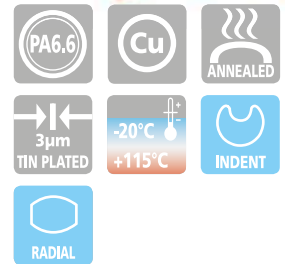

Recommended crimping tools are shown on pages 126, 137.

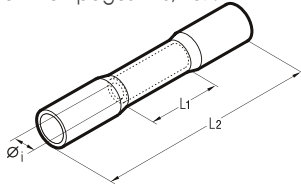

PE HD insulated, heat shrinkable

Conductor Size sqmm (AWG)	Type	ø mm	L1 mm	L2 mm	Quantity Box/Bag
0,5÷1,5 (22÷16)	WL03-M	1,7	15,0	36,0	1.500/100
1,5÷2,5 (16÷14)	WL06-M	2,3	15,0	36,0	1.000/100
4÷6 (12÷10)	WL1-M	3,5	15,0	41,0	500/100

- Max operating voltage: 600 V
- Shrink temperature: 150 °C
- Protection: IP68



CLOSE END CONNECTORS

for Copper conductors

Recommended crimping tools are shown on pages 124 to 151, 192, 257.

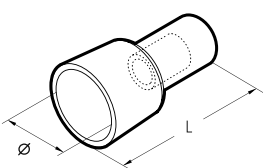

Polyamide PA6.6 insulated

Conductor Size sqmm (AWG)	Type	ø mm	L mm	Quantity Box/Bag
0,25÷1,5 (22÷16)	NL03-P	7,9	21,0	1.000/100
1,5÷2,5 (16÷14)	NL06-P	7,9	19,9	1.000/100
	NL06-PB	6,5	13,6	1.500/100
4÷6 (12÷10)	NL1-P	10,5	21,5	500/100
	NL1-PG	9,0	17,8	1.000/100



*Not UL approved

VP RP BP GP

HALOGEN FREE INSULATED TERMINALS

P range funnel entry - for Copper conductors

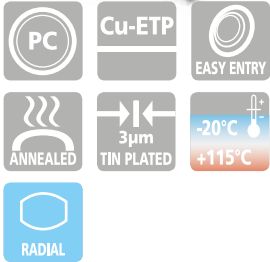

The "P" range of terminals has been designed, to meet the increasing demands for improved safety and reliability of electrical connectors.

The Polycarbonate insulation type PC10500AC certified EN45545-2, is a Halogen free, self extinguishing thermoplastic material class V0 (UL 94). The unique funnel shaped entry of the insulation sleeve, guarantees total insertion of the con-

ductor strands into the terminal barrel, creating a secure and reliable, electrical and mechanical connection.

The operating temperature range is -20 to +115°C (Surge +130°C).

Recommended crimping tools are shown on pages 124 to 151, 192, 257.



pin terminals

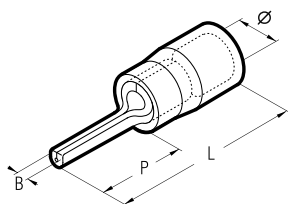

Conductor Size sqmm (AWG)	Type	Dimensions mm				Quantity Box/Bag
		Ø	B	P	L	
0,2÷0,5 (24÷20)	VP-P10	3,0	1,0	9,8	20,2	4.000/100
0,25÷1,5 (22÷16)	RP-P8	4,0	1,6	7,8	17,9	3.000/100
	RP-P10	4,0	1,6	9,8	19,9	3.000/100
	RP-P12	4,0	1,6	12,0	22,1	3.000/100
1,5÷2,5 (16÷14)	BP-P8	4,9	1,6	7,8	17,9	3.000/100
	BP-P10	4,9	1,6	9,8	19,9	3.000/100
	BP-P12	4,9	1,6	11,8	21,9	2.500/100
4÷6 (12÷10)	GP-P10	6,6	2,2	10,4	24,5	1.000/100
	GP-P12	6,6	2,2	12,6	26,7	1.000/100
	GP-P14	6,6	2,2	14,6	28,7	1.000/100

blade terminals

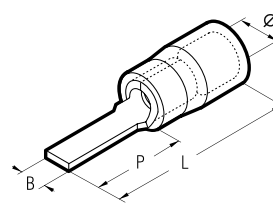

Conductor Size sqmm (AWG)	Type	Dimensions mm				Quantity Box/Bag
		Ø	B	P	L	
0,2÷0,5 (24÷20)	VP-PP12/19	3,0	1,9	12,4	22,4	4.000/100
0,25÷1,5 (22÷16)	RP-PP12	4,0	3,0	12,8	22,9	3.000/100
	RP-PP12/1	4,0	3,0	11,3	21,4	3.000/100
	RP-PP12/19	4,0	1,9	13,2	23,3	3.000/100
	RP-PP12/23	4,0	2,3	13,2	23,3	2.500/100
	RP-PP14	4,0	3,0	14,8	24,9	2.500/100
	RP-PP16/23	4,0	2,3	17,2	27,3	2.500/100
1,5÷2,5 (16÷14)	BP-PP12	4,9	3,5	12,8	22,9	2.500/100
	BP-PP12/25	4,9	2,5	13,3	23,4	2.000/100
	BP-PP12/29	4,9	2,9	13,3	23,4	2.500/100
	BP-PP16/25	4,9	2,5	17,2	27,3	2.500/100
4÷6 (12÷10)	GP-PP12	6,6	4,0	13,3	27,4	1.000/100
	GP-PP17	6,6	2,9	19,1	33,2	1.000/100

hooked blade terminals

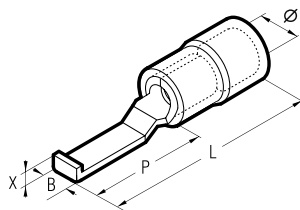

Conductor Size sqmm (AWG)	Type	Dimensions mm					Quantity Box/Bag
		Ø	B	P	L	X	
0,25÷1,5 (22÷16)	RP-PPL30*	4,0	3,0	17,5	28,3	1,7	3.000/100
	RP-PPL46*	4,0	4,6	17,5	28,3	1,7	3.000/100
1,5÷2,5 (16÷14)	BP-PPL30*	4,9	3,0	17,5	28,3	1,7	2.500/100
	BP-PPL46*	4,9	4,6	17,5	28,8	1,7	2.500/100
4÷6 (12÷10)	GP-PPL46*	6,6	4,6	17,5	32,6	1,9	1.000/100

*Not UL approved

HALOGEN FREE INSULATED TERMINALS

P range funnel entry - for Copper conductors

VP RP
BP GP

ring terminals

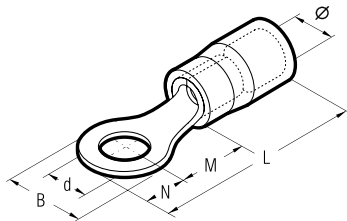

fork/spade terminals

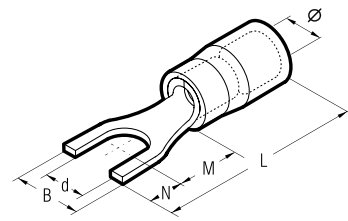

Cond. Size sqmm (AWG)	Ø Stud mm	Type	Dimensions mm						Quantity Box/Bag
			Ø	B	M	N	L	d	
0,25÷0,5 (24÷20)	3,0	2 VP-M2*	3,0	5,6	4,5	2,8	17,5	2,2	4.000/100
		3 VP-M3	3,0	5,6	4,5	2,8	17,5	3,2	4.000/100
		3,5 VP-M3.5	3,0	5,6	4,5	2,8	17,5	3,7	4.000/100
		4 VP-M4	3,0	7,0	6,5	3,5	20,2	4,3	4.000/100
		5 VP-M5	3,0	7,8	7,1	3,9	21,2	5,3	4.000/100
		6 VP-M6*	3,0	9,4	8,1	4,7	23,0	6,4	4.000/100
0,25÷1,5 (22÷16)	4,0	2 RP-M2*	4,0	5,6	4,5	2,8	17,4	2,2	3.000/100
		3 RP-M3	4,0	5,6	4,5	2,8	17,4	3,2	3.000/100
		3,5 RP-M3.5	4,0	5,6	4,5	2,8	17,4	3,7	3.000/100
		3,5 RP-M3.5/1	4,0	6,2	7,1	3,1	20,2	3,7	3.000/100
		4 RP-M4	4,0	7,0	6,5	3,5	20,1	4,3	3.000/100
		4 RP-M4/3	4,0	7,8	7,1	3,9	21,1	4,3	3.000/100
		5 RP-M5	4,0	7,8	7,1	3,9	21,1	5,3	2.500/100
		6 RP-M6	4,0	9,4	8,1	4,7	22,9	6,4	2.500/100
		6 RP-M6/1	4,0	12,0	10,3	6,0	26,4	6,4	2.000/100
		7 RP-M7	4,0	9,4	8,1	4,7	22,9	7,2	2.500/100
		8 RP-M8	4,0	12,0	10,3	6,0	26,4	8,4	2.500/100
		10 RP-M10	4,0	15,5	13,0	7,7	30,9	10,5	2.000/100
12 RP-M12	4,0	18,0	15,5	9,0	34,6	13,0	2.000/100		
1,5÷2,5 (16÷14)	4,9	2 BP-M2*	4,9	5,6	5,0	2,8	17,9	2,2	2.500/100
		3 BP-M3	4,9	5,6	5,0	2,8	17,9	3,2	2.500/100
		3,5 BP-M3.5	4,9	5,6	5,0	2,8	17,9	3,7	3.000/100
		3,5 BP-M3.5/1	4,9	6,2	6,5	3,1	19,7	3,7	2.500/100
		4 BP-M4	4,9	8,0	6,5	4,0	20,6	4,3	2.500/100
		5 BP-M5	4,9	8,0	7,5	4,0	21,6	5,3	2.000/100
		6 BP-M6	4,9	9,4	8,6	4,7	23,4	6,4	2.000/100
		6 BP-M6/1	4,9	12,0	10,3	6,0	26,4	6,4	2.000/100
		6 BP-M6/2*	4,9	8,4	5,4	4,2	19,7	6,4	2.500/100
		7 BP-M7	4,9	10,0	7,8	5,0	22,9	7,2	2.500/100
		8 BP-M8	4,9	12,0	10,3	6,0	26,4	8,4	1.500/100
		10 BP-M10	4,9	15,5	13,0	7,7	30,9	10,5	1.500/100
12 BP-M12	4,9	18,0	15,5	9,0	34,6	13,0	1.500/100		
4÷6 (12÷10)	6,6	3 GP-M3	6,6	8,0	8,1	4,0	26,2	3,2	1.000/100
		3,5 GP-M3.5	6,6	8,0	8,1	4,0	26,2	3,7	1.500/100
		4 GP-M4	6,6	9,0	8,1	4,5	26,7	4,3	1.000/100
		5 GP-M5	6,6	9,0	8,1	4,5	26,7	5,3	1.000/100
		6 GP-M6	6,6	11,0	11,1	5,5	30,7	6,4	1.000/100
		6 GP-M6/1	6,6	11,0	11,1	5,5	27,7	6,4	1.000/100
		7 GP-M7	6,6	11,0	11,1	5,5	30,7	7,2	1.000/100
		8 GP-M8	6,6	13,6	12,1	6,8	33,0	8,4	800/100
		8 GP-M8/1*	6,6	11,0	8,1	5,5	27,7	8,4	1.000/100
		10 GP-M10	6,6	13,6	12,1	6,8	33,0	10,5	1.000/100
		10 GP-M10/1	6,6	15,5	13,8	7,7	35,7	10,5	1.000/100
		12 GP-M12	6,6	19,0	15,1	9,5	38,7	13,0	500/100
		14 GP-M14	6,6	21,0	16,1	10,5	40,7	15,0	500/100
		16 GP-M16	6,6	24,0	17,1	12,0	43,2	17,0	500/100

Cond. Size sqmm (AWG)	Ø Stud mm	Type	Dimensions mm						Quantity Box/Bag		
			Ø	B	M	N	L	d			
0,2÷0,5 (24÷20)	3,0	3 VP-U3	3,0	5,5	5,5	4,0	18,7	3,2	4.000/100		
		3,5 VP-U3.5	3,0	6,0	6,5	3,8	19,5	3,7	4.000/100		
		4 VP-U4	3,0	6,5	7,5	3,7	20,4	4,3	4.000/100		
		3 RP-U3	4,0	5,5	5,5	4,0	19,6	3,2	3.000/100		
0,25÷1,5 (22÷16)	4,0	3,5 RP-U3.5	4,0	6,0	6,5	3,8	20,4	3,7	3.000/100		
		3,5 RP-U3.5/2	4,0	6,4	6,5	3,8	20,4	3,7	3.000/100		
		4 RP-U4	4,0	6,5	7,5	3,7	21,3	4,3	3.000/100		
		4 RP-U4/1	4,0	8,5	7,5	3,7	21,3	4,3	3.000/100		
		4 RP-U4/2	4,0	7,5	7,5	3,7	21,3	4,3	3.500/100		
		5 RP-U5	4,0	8,5	7,5	3,7	21,3	5,3	3.000/100		
		5 RP-U5/1*	4,0	9,4	7,5	3,7	21,3	5,3	3.000/100		
		6 RP-U6	4,0	9,4	8,1	4,7	22,9	6,4	2.000/100		
		6 RP-U6/1	4,0	12,0	9,2	7,1	26,4	6,4	2.000/100		
		8 RP-U8	4,0	14,0	10,0	6,3	26,4	8,4	2.000/100		
		10 RP-U10	4,0	17,5	13,0	7,7	30,9	10,5	1.500/100		
		12 RP-U12	4,0	20,0	15,5	9,0	34,6	13,0	1.500/100		
		1,5÷2,5 (16÷14)	4,9	3 BP-U3	4,9	5,5	5,5	4,0	19,6	3,2	2.500/100
				3,5 BP-U3.5	4,9	6,4	6,5	3,8	20,4	3,7	2.500/100
				3,5 BP-U3.5/1*	4,9	7,2	6,5	3,8	20,4	3,7	2.500/100
				4 BP-U4	4,9	6,5	7,5	3,7	21,3	4,3	2.500/100
4 BP-U4/1	4,9			8,5	7,5	3,7	21,3	4,3	3.000/100		
4 BP-U4/2	4,9			7,5	7,5	3,7	21,3	4,3	2.000/100		
5 BP-U5	4,9			8,5	7,5	3,7	21,3	5,3	2.000/100		
6 BP-U6	4,9			9,4	8,1	4,7	22,9	6,4	2.000/100		
6 BP-U6/1	4,9			12,0	9,2	7,1	26,4	6,4	2.000/100		
8 BP-U8	4,9			14,0	10,0	6,3	26,4	8,4	1.500/100		
10 BP-U10	4,9			17,5	13,0	7,7	30,9	10,5	1.000/100		
12 BP-U12	4,9			20	15,5	9,0	34,6	13,0	1.500/100		
4÷6 (12÷10)	6,6			3,5 GP-U3.5	6,6	7,5	8,5	3,9	26,5	3,7	1.000/100
				4 GP-U4	6,6	7,5	8,0	4,4	26,5	4,3	1.000/100
				5 GP-U5	6,6	9,5	8,0	4,4	26,5	5,3	1.000/100
				6 GP-U6	6,6	10,0	11,0	5,5	30,6	6,4	1.000/100
		8 GP-U8	6,6	13,5	12,0	8,0	34,1	8,4	1.000/100		
		10 GP-U10	6,6	15,5	13,0	8,0	35,1	10,5	1.000/100		
		10 GP-U10/1	6,6	17,5	13,8	7,7	35,7	10,5	1.000/100		
		12 GP-U12	6,6	21,0	15,1	9,5	38,7	13,0	500/100		
		14 GP-U14	6,6	23,0	16,1	10,5	40,7	15,0	500/100		
		16 GP-U16	6,6	26,0	17,1	11,5	42,7	17,0	500/100		

*Made to order

CRP CBP CGP

INSULATED CHAIN TERMINALS

CP range with easy entry - for Copper conductors

The "CP" range of terminals has been designed to meet the increasing demands for improved safety and reliability of electrical connectors. Developed for use with production equipment, to give a quick and reliable crimped joint, the Polycarbonate insulation type PC10500AC certified EN45545-2, is a Halogen free, self extinguishing thermoplastic material class V0 (UL 94). The unique funnel shaped entry of the insulation sleeve guarantees

strands into the terminal barrel, creating a secure and reliable, electrical and mechanical connection. The operating temperature range is -20 to +115°C (Surge +130°C).

stands into the terminal barrel, creating a secure and reliable, electrical and mechanical connection. The operating temperature range is -20 to +115°C (Surge +130°C).

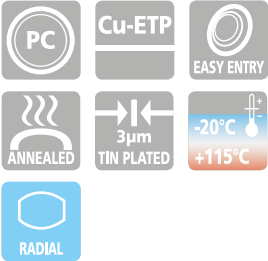

pin terminals

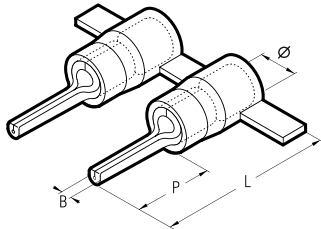

blade terminals

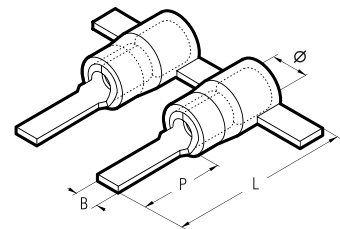

Conductor Size sqmm (AWG)	Type	Dimensions mm				Quantity
		Ø	B	P	L	
0,25÷1,5 (22÷16)	CRP-P8	4,0	1,6	8,0	17,9	2.000
	CRP-P10	4,0	1,6	10,0	19,9	2.000
	CRP-P12	4,0	1,6	12,0	22,1	2.000
1,5÷2,5 (16÷14)	CBP-P8	4,9	1,6	8,0	17,9	1.750
	CBP-P10	4,9	1,6	10,0	19,9	1.750
	CBP-P12	4,9	1,6	12,0	21,9	1.750
4÷6 (12÷10)	CGP-P10	6,6	2,2	10,0	24,5	1.250
	CGP-P12	6,6	2,2	12,0	26,7	1.250
	CGP-P14	6,6	2,2	14,0	28,7	1.250

Conductor Size sqmm (AWG)	Type	Dimensions mm				Quantity
		Ø	B	P	L	
0,25÷1,5 (22÷16)	CRP-PP12	4,0	3,0	12,8	22,9	2.000
	CRP-PP12/1*	4,0	3,0	11,3	21,4	2.000
	CRP-PP12/23*	4,0	2,3	13,2	23,3	2.000
	CRP-PP14	4,0	3,0	14,8	24,9	2.000
1,5÷2,5 (16÷14)	CBP-PP12	4,9	3,5	12,8	22,9	1.750
	CBP-PP12/25*	4,9	2,5	13,3	23,4	1.750
4÷6 (12÷10)	CGP-PP12	6,6	4,0	13,3	27,4	1.250
4÷6 (12÷10)	CGP-PP17*	6,6	2,9	19,1	33,2	1.250

male disconnect terminals

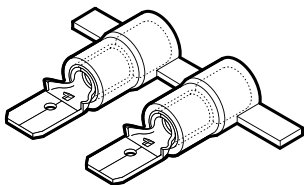

Conductor Size sqmm (AWG)	Type	Tab Size mm	Quantity
0,25÷1,5 (22÷16)	CRP-M608	6,35 x 0,8	2.000
1,5÷2,5 (16÷14)	CBP-M608	6,35 x 0,8	1.750
4÷6 (12÷10)	CGP-M608	6,35 x 0,8	1.250

female disconnect terminals

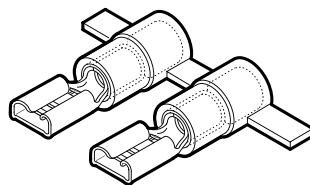

Conductor Size sqmm (AWG)	Type	Tab Size mm	Quantity
0,25÷1,5 (22÷16)	CRP-F305	2,8 x 0,5	2.000
	CRP-F308	2,8 x 0,8	2.000
	CRP-F405	4,8 x 0,5	2.000
	CRP-F408	4,8 x 0,8	2.000
	CRP-F608	6,35 x 0,8	2.000
1,5÷2,5 (16÷14)	CBP-F405	4,8 x 0,5	1.750
	CBP-F408	4,8 x 0,8	1.750
	CBP-F608	6,35 x 0,8	1.750
4÷6 (12÷10)	CGP-F608	6,35 x 0,8	1.250

female disconnect terminals fully insulated

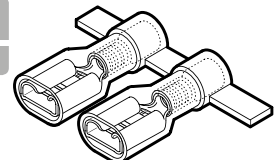

Conductor Size sqmm (AWG)	Type	Tab Size mm	Quantity
0,25÷1,5 (22÷16)	CRP-F405P*	4,8 x 0,5	2.000
	CRP-F408P*	4,8 x 0,8	2.000
	CRP-F608P*	6,35 x 0,8	1.500
1,5÷2,5 (16÷14)	CBP-F408P*	4,8 x 0,8	1.500
	CBP-F608P*	6,35 x 0,8	1.500
4÷6 (12÷10)	CGP-F608P*	6,35 x 0,8	1.250

*Not UL approved *Made to order

INSULATED CHAIN TERMINALS

CP range with easy entry - for Copper conductors

CRP CBP CGP

fork/spade terminals

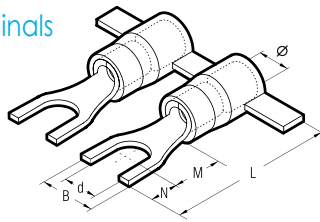

Cond. Size sqmm (AWG)	Ø Stud mm	Type	Dimensions mm					Quantity	
			Ø	B	M	N	L		d
0,25÷1,5 (22÷16)	3	CRP-U3	4,0	5,5	5,5	4,0	19,6	3,2	2.000
	3,5	CRP-U3.5	4,0	6,0	6,5	3,8	20,4	3,7	2.000
	3,5	CRP-U3.5/2*	4,0	6,4	6,5	3,8	20,4	3,7	2.000
	4	CRP-U4	4,0	6,5	7,5	3,7	21,3	4,3	2.000
	4	CRP-U4/1*	4,0	8,5	7,5	3,7	21,3	4,3	2.000
	4	CRP-U4/2*	4,0	7,5	7,5	3,7	21,3	4,3	2.000
	5	CRP-U5	4,0	8,5	7,5	3,7	21,3	5,3	2.000
	6	CRP-U6	4,0	9,4	8,1	4,7	22,9	6,4	2.000
1,5÷2,5 (16÷14)	6	CRP-U6/1*	4,0	12,0	9,2	7,1	26,4	6,4	2.000
	8	CRP-U8*	4,0	14,0	10,0	6,3	26,4	8,4	2.000
	3	CBP-U3	4,9	5,5	5,5	4,0	19,6	3,2	1.750
	3,5	CBP-U3.5	4,9	6,4	6,5	3,8	20,4	3,7	1.750
	4	CBP-U4	4,9	6,5	7,5	3,7	21,3	4,3	1.750
	4	CBP-U4/1*	4,9	8,5	7,5	3,7	21,3	4,3	1.750
4÷6 (12÷10)	4	CBP-U4/2*	4,9	7,5	7,5	3,7	21,3	4,3	1.750
	5	CBP-U5	4,9	8,5	7,5	3,7	21,3	5,3	1.750
	6	CBP-U6	4,9	9,4	8,1	4,7	22,9	6,4	1.750
	3,5	CGP-U3.5*	6,6	7,5	8,5	3,9	26,5	3,7	1.250
	4	CGP-U4*	6,6	7,5	8,0	4,4	26,5	4,3	1.250
	5	CGP-U5	6,6	9,5	8,0	4,4	26,5	5,3	1.250

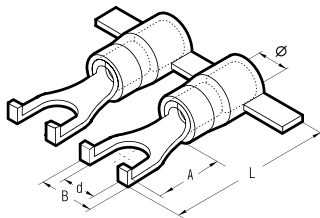

Cond. Size sqmm (AWG)	Ø Stud mm	Type	Dimensions mm					Quantity
			Ø	B	A	L	d	
1,5÷2,5 (16÷14)	4	CBP-U 4/3L*	4,9	6,5	9,5	14,5	4,3	1.750

hooked blade terminals

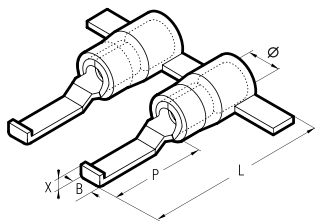

Cond. Size sqmm (AWG)	Type	Dimensions mm					Quantity
		Ø	B	P	L	X	
0,25÷1,5 (22÷16)	CRP-PPL30*	4,0	3,0	17,5	28,8	1,7	2.000
1,5÷2,5 (16÷14)	CBP-PPL30*	4,9	3,0	17,5	28,8	1,7	1.750

ring terminals

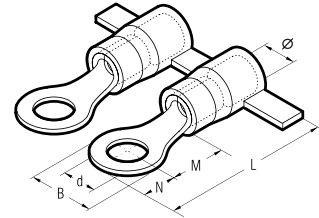

Cond. Size sqmm (AWG)	Ø Stud mm	Type	Dimensions mm					Quantity	
			Ø	B	M	N	L		d
0,25÷1,5 (22÷16)	3	CRP-M3	4,0	5,6	4,5	2,8	17,4	3,2	2.000
	3,5	CRP-M3.5*	4,0	5,6	4,5	2,8	17,4	3,7	2.000
	3,5	CRP-M3.5/1	4,0	6,2	7,1	3,1	20,2	3,7	2.000
	4	CRP-M4	4,0	7,0	6,5	3,5	20,1	4,3	2.000
	4	CRP-M4/3*	4,0	7,8	7,1	3,9	21,1	4,3	2.000
	5	CRP-M5	4,0	7,8	7,1	3,9	21,1	5,3	2.000
	6	CRP-M6	4,0	9,4	8,1	4,7	22,9	6,4	2.000
	6	CRP-M6/1*	4,0	12,0	10,3	6,0	26,4	6,4	2.000
1,5÷2,5 (16÷14)	7	CRP-M7	4,0	9,4	8,1	4,7	22,9	7,2	2.000
	8	CRP-M8	4,0	12,0	10,3	6,0	26,4	8,4	2.000
	3	CBP-M3	4,9	5,6	5,0	2,8	17,9	3,2	1.750
	3,5	CBP-M3.5	4,9	5,6	5,0	2,8	17,9	3,7	1.750
	3,5	CBP-M3.5/1*	4,9	6,2	6,5	3,1	19,6	3,7	1.750
	4	CBP-M4	4,9	8,0	6,5	4,0	20,6	4,3	1.750
	5	CBP-M5	4,9	8,0	7,5	4,0	21,6	5,3	1.750
	6	CBP-M6	4,9	9,4	8,6	4,7	23,4	6,4	1.750
4÷6 (12÷10)	6	CBP-M6/1*	4,9	12,0	10,3	6,0	26,4	6,4	1.750
	7	CBP-M7	4,9	10,0	7,8	5,0	22,9	7,2	1.750
	8	CBP-M8	4,9	12,0	10,3	6,0	26,4	8,4	1.750
	3	CGP-M3	6,6	8,0	8,1	4,0	26,2	3,2	1.250
	3,5	CGP-M3.5	6,6	8,0	8,1	4,0	26,2	3,7	1.250
	4	CGP-M4	6,6	9,0	8,1	4,5	26,7	4,3	1.250
	5	CGP-M5	6,6	9,0	8,1	4,5	26,7	5,3	1.250
	6	CGP-M6	6,6	11,0	11,1	5,5	30,7	6,4	1.250
	6	CGP-M6/1*	6,6	11,0	8,1	5,5	27,7	6,4	1.250
	7	CGP-M7	6,6	11,0	11,1	5,5	30,7	7,2	1.000
8	CGP-M8	6,6	13,6	12,1	6,8	33,0	8,4	1.250	
8	CGP-M8/1*	6,6	11,0	8,1	5,5	27,7	8,4	1.250	
10	CGP-M10	6,6	13,6	12,1	6,8	33,0	10,5	1.250	



Interchangeable application heads are available for crimping these terminals with the bench press ELB-3 (see page 154).

*Not UL approved *Made to order

RKY BKY GKY

REINFORCED PA 6.6 INSULATED TERMINALS

KY range - for Copper conductors

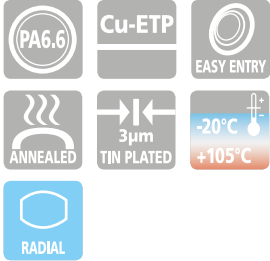

'KY' type terminals are designed to offer improved mechanical and electrical integrity under heavy-duty application.

This is achieved via a Copper sleeve located between the Copper barrel and Polyamide insulation of the terminal. Then, during crimping, the insulation of the conductor is integrated into the crimp due to the Copper sleeve being deformed around it to maintain the level of 'grip' required in applications subject to continuous mechanical vibrations (e.g: mobile plant, vehicles, moving components).

The operating temperature range is -20 to $+105^{\circ}\text{C}$ (Surge $+110^{\circ}\text{C}$). Recommended crimping tools are shown on pages 124 to 151, 192, 257.



HF
HALOGEN
FREE

pin terminals

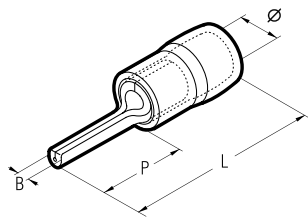

Conductor Size sqmm (AWG)	Type	Dimensions mm				Quantity Box/Bag
		Ø	B	P	L	
0,25÷1,5 (22÷16)	RKY-P8	4,5	1,9	9,0	19,8	3.000/100
	RKY-P10	4,5	1,9	10,0	20,8	3.500/100
	RKY-P12	4,5	1,9	12,0	22,8	3.000/100
1,5÷2,5 (16÷14)	BKY-P8	5,2	1,9	9,0	19,8	3.000/100
	BKY-P10	5,2	1,9	10,0	20,8	3.000/100
	BKY-P12	5,2	1,9	12,0	22,8	3.000/100
4÷6 (12÷10)	GKY-P14	7,0	2,8	14,0	27,0	1.000/100

blade terminals

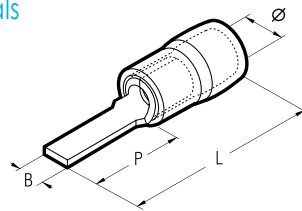

Conductor Size sqmm (AWG)	Type	Dimensions mm				Quantity Box/Bag
		Ø	B	P	L	
0,25÷1,5 (22÷16)	RKY-PP12	4,5	3,0	13,0	23,8	3.000/100
	RKY-PP12/19	4,5	2,0	18,0	28,8	3.000/100
	RKY-PP16/23	4,5	2,2	18,0	28,8	2.500/100
1,5÷2,5 (16÷14)	BKY-PP12	5,2	3,0	13,0	23,8	2.500/100
	BKY-PP12/25	5,2	2,4	13,0	23,8	2.000/100
	BKY-PP16/23	5,2	2,2	18,0	28,8	2.500/100
4÷6 (12÷10)	GKY-PP12	7,0	4,0	14,0	27,0	1.000/100
	GKY-PP17	7,0	2,0	18,0	31,0	1.000/100

hooked blade terminals

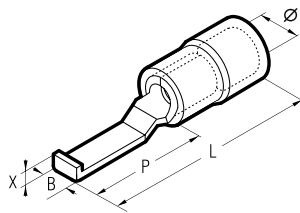

Conductor Size sqmm (AWG)	Type	Dimensions mm					Quantity Box/Bag
		Ø	B	P	L	X	
0,25÷1,5 (22÷16)	RKY-PPL30	4,5	3,0	16,8	28,2	2,1	3.000/100
	RKY-PPL46	4,5	4,6	16,8	28,2	2,1	3.000/100
1,5÷2,5 (16÷14)	BKY-PPL30	5,2	3,0	16,8	28,2	2,1	2.500/100
	BKY-PPL46	5,2	4,6	16,8	28,2	2,1	2.500/100
4÷6 (12÷10)	GKY-PPL46	7,0	4,6	17,2	30,2	2,4	1.000/100

Consult Cembre for a wider range of pin and blade dimensions.

REINFORCED PA 6.6 INSULATED TERMINALS

KY range - for Copper conductors

RKY BKY GKY

ring terminals

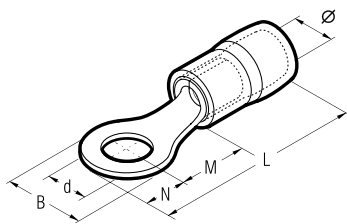

Cond. Size sqmm (AWG)	Ø Stud mm	Type	Dimensions mm						Quantity Box/Bag
			Ø	B	M	N	L	d	
0,25÷1,5 (22÷16)	3	RKY-M3	4,5	5,5	5,0	2,5	18,5	3,2	3.000/100
	3,5	RKY-M3.5	4,5	5,5	5,0	2,5	18,5	3,7	3.000/100
	3,5	RKY-M3.5/1	4,5	6,6	6,3	3,1	20,4	3,7	3.000/100
	4	RKY-M4	4,5	6,6	6,3	3,1	20,4	4,3	3.000/100
	5	RKY-M5	4,5	8,0	7,0	3,8	21,8	5,3	2.500/100
	6	RKY-M6/1	4,5	11,6	11,0	5,8	27,8	6,4	2.000/100
	8	RKY-M8	4,5	11,6	11,0	5,8	27,8	8,4	2.500/100
	10	RKY-M10	4,5	13,6	13,9	6,6	31,5	10,5	1.500/100
	12	RKY-M12	4,5	19,6	16,0	9,4	36,4	13,0	1.500/100
	3	BKY-M3	5,2	6,6	4,8	3,0	18,8	3,2	2.500/100
	3,5	BKY-M3.5	5,2	6,6	4,8	3,0	18,8	3,7	2.500/100
	1,5÷2,5 (16÷14)	3,5	BKY-M3.5/1	5,2	6,6	6,3	3,1	20,4	3,7
4		BKY-M4	5,2	8,5	7,8	4,0	22,8	4,3	2.500/100
5		BKY-M5	5,2	8,5	7,8	4,0	22,8	5,3	2.500/100
6		BKY-M6/1	5,2	12,0	11,0	5,8	27,8	6,4	2.000/100
8		BKY-M8	5,2	12,0	11,0	5,8	27,8	8,4	1.500/100
10		BKY-M10	5,2	13,6	13,9	6,6	31,5	10,5	1.500/100
4÷6 (12÷10)	12	BKY-M12	5,2	19,2	16,0	9,4	36,4	13,0	1.000/100
	3,5	GKY-M3.5	7,0	7,2	6,1	3,6	22,7	3,7	1.000/100
	4	GKY-M4	7,0	9,5	9,1	4,5	26,6	4,3	1.000/100
	5	GKY-M5	7,0	9,5	9,1	4,5	26,6	5,3	1.000/100
	6	GKY-M6	7,0	12,0	10,5	6,0	29,5	6,4	1.000/100
	8	GKY-M8	7,0	15,0	13,5	7,5	34,0	8,4	1.000/100
	10	GKY-M10	7,0	15,0	13,5	7,5	34,0	10,5	1.000/100
	12	GKY-M12	7,0	19,2	16,0	9,6	38,6	13,0	1.000/100
14	GKY-M14	7,0	32,0	25,2	16,0	54,2	15,0	500/100	
16	GKY-M16	7,0	32,0	25,2	16,0	54,2	17,0	500/100	

fork/spade terminals

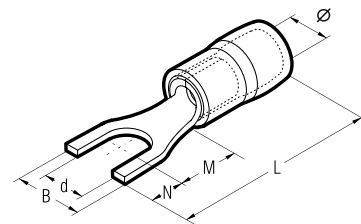

Cond. Size sqmm (AWG)	Ø Stud mm	Type	Dimensions mm						Quantity Box/Bag
			Ø	B	M	N	L	d	
0,25÷1,5 (22÷16)	3	RKY-U3	4,5	5,7	6,5	4,5	22,0	3,2	2.500/100
	3,5	RKY-U3.5	4,5	5,7	6,5	4,5	22,0	3,7	2.500/100
	4	RKY-U4	4,5	6,4	6,5	4,5	22,0	4,3	3.000/100
	5	RKY-U5	4,5	8,1	6,5	4,5	22,0	5,3	3.000/100
	6	RKY-U6	4,5	9,5	6,5	4,5	22,0	6,4	2.000/100
	6	RKY-U6/1	4,5	12,0	11,0	6,0	28,0	6,4	2.000/100
1,5÷2,5 (16÷14)	3	BKY-U3	5,2	5,7	6,5	4,5	22,0	3,2	2.500/100
	3,5	BKY-U3.5	5,2	6,0	6,5	4,5	22,0	3,7	2.500/100
	4	BKY-U4	5,2	6,4	6,5	4,5	22,0	4,3	2.500/100
	5	BKY-U5	5,2	7,9	6,5	4,5	22,0	5,3	2.000/100
	6	BKY-U6	5,2	9,3	6,5	4,5	22,0	6,4	2.000/100
	6	BKY-U6/1	5,2	12,0	11,0	6,0	28,0	6,4	2.000/100
4÷6 (12÷10)	3,5	GKY-U3.5	7,0	7,2	7,5	3,9	24,4	3,7	1.000/100
	4	GKY-U4	7,0	7,2	7,5	3,9	24,4	4,3	1.000/100
	5	GKY-U5	7,0	9,0	7,0	5,5	25,5	5,3	1.000/100
	6	GKY-U6	7,0	12,0	12,0	6,5	31,5	6,4	1.000/100
8	GKY-U8	7,0	14,0	10,5	7,0	30,5	8,4	1.000/100	

Consult Cembre for a wider range of pin and blade dimensions.

RKF-F BKF-F GK-F

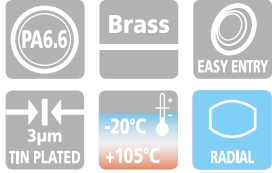

Recommended crimping tools are shown on pages 124 to 151, 192, 257.

female connectors, fully reinforced with Copper sleeve

PA6.6 insulated terminals

Conductor Size sqmm (AWG)	Type	Tab Size mm	Quantity Box/Bag
0,25÷1,5 (22÷16)	RKF-F305	2,8 x 0,5	3.000/100
	RKF-F308	2,8 x 0,8	3.000/100
	RKF-F405	4,8 x 0,5	2.500/100
	RKF-F408	4,8 x 0,8	2.500/100
1,5÷2,5 (16÷14)	RKF-F608	6,35 x 0,8	2.500/100
	BKF-F405	4,8 x 0,5	2.500/100
	BKF-F408	4,8 x 0,8	2.500/100
4÷6 (12÷10)	BKF-F608	6,35 x 0,8	2.000/100
	GK-F608	6,35 x 0,8	1.500/100

PA6.6 fully insulated terminals

Conductor Size sqmm (AWG)	Type	Tab Size mm	Quantity Box/Bag
0,25÷1,5 (22÷16)	RKF-F405P	4,8 x 0,5	1.500/100
	RKF-F408P	4,8 x 0,8	2.000/100
1,5÷2,5 (16÷14)	RKF-F608P	6,35 x 0,8	1.000/100
	BKF-F405P	4,8 x 0,5	1.500/100
4÷6 (12÷10)	BKF-F408P	4,8 x 0,8	2.000/100
	BKF-F608P	6,35 x 0,8	1.000/100
	GK-F608P	6,35 x 0,8	1.000/100



RKF BKF GKF

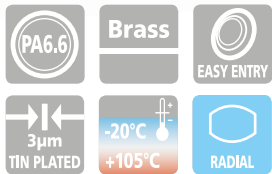

male connectors, fully reinforced with Copper sleeve - PA6.6 insulated terminals

Conductor Size sqmm (AWG)	Type	Tab Size mm	Quantity Box/Bag
0,25÷1,5 (22÷16)	RKF-M608	6,35 x 0,8	3.000/100
1,5÷2,5 (16÷14)	BKF-M608	6,35 x 0,8	2.500/100
4÷6 (12÷10)	GKF-M608	6,35 x 0,8	1.000/100

Recommended crimping tools are shown on pages 124 to 151, 192, 257.



male/female connectors, fully reinforced with Copper sleeve PA6.6 insulated terminals

Conductor Size sqmm (AWG)	Type	Tab Size mm	Quantity Box/Bag
0,25÷1,5 (22÷16)	RKF-FM608	6,35 x 0,8	1.500/100
1,5÷2,5 (16÷14)	BKF-FM608	6,35 x 0,8	1.500/100

bullet and socket connectors fully reinforced with Copper sleeve PA6.6 insulated terminals

Conductor Size sqmm (AWG)	Type	Ø mm	Quantity Box/Bag
0,25÷1,5 (22÷16)	RKF-BM4	4,0	2.500/100
	RKF-BF4	3,95	1.000/100
1,5÷2,5 (16÷14)	BKF-BM4	4,0	2.000/100
	BKF-BF4	3,95	800/100

RN-FA BN-FA



Recommended crimping tools are shown on pages 124 to 151, 257.

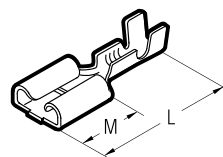

FEMALE CONNECTORS

for Copper conductors

Conductor Size sqmm (AWG)	Type	Tab Size mm	M mm	L mm	Quantity Box/Bag
0,5÷1 (20÷17)	RN-FA305	2,8 x 0,5	6,3	15,0	6.000/100
	RN-FA405	4,8 x 0,5	6,3	15,0	5.000/100
	RN-FA608	6,3 x 0,8	7,7	19,0	3.000/100
1÷2,5 (17÷14)	BN-FA608	6,3 x 0,8	7,7	19,0	2.000/100
	BN-FAB608*	6,3 x 0,8	7,7	15,5	2.000/100
	BN-FAR608**	6,3 x 0,8	7,7	19,0	3.000/100

*flag type **with retainer

MALE CONNECTORS

open barrel - for Copper conductors

Conductor Size sqmm (AWG)	Type	Tab Size mm	M mm	L mm	Quantity Box/Bag
0,5÷1 (20÷17)	RN-MA305	2,8 x 0,5	5,8	13,0	6.000/100
	RN-MA405	4,8 x 0,5	6,3	17,3	5.000/100
	RN-MA608	6,3 x 0,8	7,9	19,7	4.000/100
1÷2,5 (17÷14)	BN-MA608	6,3 x 0,8	7,9	20,0	4.000/100

Recommended crimping tools are shown on page 130.

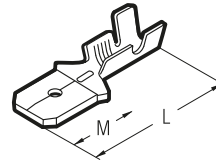

RN-MA BN-MA

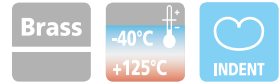

MALE TABS

for board mounting - for Copper conductors

Type	Tab Size mm	Ø Stud mm	B mm	C mm	α	Quantity Box/Bag
MP608	6,3 x 0,8	4,0	8,0	11,0	0°	5.000/100
MP608/45	6,3 x 0,8	4,0	8,0	8,5	45°	6.000/100
MP608/90	6,3 x 0,8	4,0	8,0	8,5	90°	5.000/100
MP608D*	6,3 x 0,8	5,0	8,0	14,0	0°	5.000/100

*double tab

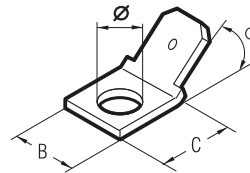

MP MPD



CONNECTOR SLEEVES

Type	Connector	B mm	M mm	L mm	Material	Quantity Box/Bag
CFA300	Female 2,8	5,5	7	18	Polyethylene	3.000/100
CFA400*	Female 4,8	7,5	9	20	Polyethylene	2.000/100
CFA600*	Female 6,3	9,0	11	24	Polyethylene	1.000/100
CFA2-600**	Female 6,3	9,0	9	22	Polyethylene	1.000/100
CFAR600	Female 6,3 with retainer	9,0	12	25	Polyamide 6.6	500/100
CFAB600	Female 6,3 flag	10,0	-	18	Polyamide 6.6	500/50
CMA600*	Male 6,3	12,0	11	22	Polyethylene	500/100

CFA CMA

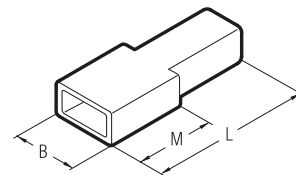

*For a single cable.
Colours available:
Transparent: no suffix
Red: add suffix R
Black: add suffix N

**For twin cables.
Colours available:
Transparent: no suffix
Red: add suffix R
Black: add suffix N
Green: add suffix V
Blue: add suffix B
Yellow: add suffix G

Max operating temperature:

- CFA300; CFA400; CFA600; CFA2-600; CMA600 (PE) 65°C
- CFAR600; CFAB600 (PA.6.6) 105°C

PKD

PA6 INSULATED END SLEEVES

for flexible Copper conductors

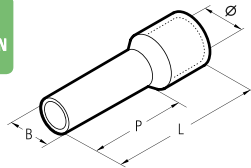

VALSTAR-ND2/PKD

- Comprising:
- a selection of end sleeves PKD conductor size 1÷6 sqmm
 - tool ND2.

VALSTAR-ND2/PKE

- Comprising:
- a selection of end sleeves PKE conductor size 1÷6 sqmm
 - tool ND2

VALSTAR-ND2/PKC

- Comprising:
- a selection of end sleeves PKC conductor size 1÷6 sqmm
 - tool ND2

The PK.. range of end sleeves is manufactured from Tin plated electrolytic Copper with a purity greater than 99.9%. Designed and developed to reinforce fine wire strands when terminating a cable into a connector block. The PKD series of insulated end sleeves comply with specification DIN 46228/4. The operating temperature range is - 20 to + 115°C (Surge + 130°C). Recommended crimping tools are shown on pages 124 to 153, 159-160, 192, 194, 196, 257.

Conductor Size sqmm	Type	Dimensions mm				Insulation Colour	Quantity Box/Bag
		Ø	B	P	L		
0,3÷0,5	PKD506	2,6	1,4	6,0	12,0	○ white	10.000/500
	PKD508	2,6	1,4	8,0	14,0		10.000/500
	PKD510	2,6	1,4	10,0	16,0		10.000/500
0,75	PKD7506	2,8	1,6	6,0	12,0	● grey	10.000/500
	PKD7508	2,8	1,6	8,0	14,0		10.000/500
	PKD7510	2,8	1,6	10,0	16,0		10.000/500
1	PKD7512	2,8	1,6	12,0	18,0	● red	10.000/500
	PKD106	3,0	1,8	6,0	12,0		10.000/500
	PKD108	3,0	1,8	8,0	14,0		10.000/500
1,5	PKD110	3,0	1,8	10,0	16,0	● black	10.000/500
	PKD112	3,0	1,8	12,0	18,0		8.000/500
	PKD1508	3,5	2,1	8,0	14,0		5.000/500
2,5	PKD1510	3,5	2,1	10,0	16,0	● blue	5.000/500
	PKD1512	3,5	2,1	12,0	18,0		5.000/500
	PKD1518	3,5	2,1	18,0	24,0		5.000/500
4	PKD2508	4,2	2,6	8,0	14,0	● blue	5.000/500
	PKD2512	4,2	2,6	12,0	18,0		4.000/500
	PKD2518	4,2	2,6	18,0	24,0		5.000/500
6	PKD410	4,8	3,3	10,0	18,0	● grey	3.000/200
	PKD412	4,8	3,3	12,0	20,0		3.000/200
	PKD418	4,8	3,3	18,0	26,0		3.000/200
10	PKD612	6,3	4,0	12,0	20,0	● yellow	1.500/100
	PKD618	6,3	4,0	18,0	26,0		1.500/100
	PKD1012	7,6	5,0	12,0	22,0		1.000/100
16	PKD1018	7,6	5,0	18,0	28,0	● red	1.000/100
	PKD1612	8,8	6,4	12,0	24,0		800/100
	PKD1618	8,8	6,4	18,0	28,0		1.000/100
25	PKD25016	11,2	7,9	16,0	30,0	● yellow	400/50
	PKD25022	11,2	7,9	22,0	36,0		500/50
	PKD35016	12,7	8,9	16,0	30,0		300/50
35	PKD35025	12,7	8,9	25,0	39,0	● red	200/50
	PKD50020	15,0	11,0	20,0	36,0		200/50
	PKD50025	15,0	11,0	25,0	41,0		200/50

PKE

PA6 INSULATED END SLEEVES

for flexible Copper conductors

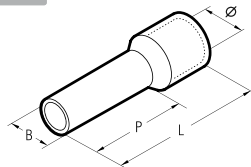

Conductor Size sqmm	Type	Dimensions mm				Insulation Colour	Quantity Box/Bag
		Ø	B	P	L		
0,1÷0,3	PKE308*	1,9	1,1	8,0	12,0	● yellow	20.000/500
0,3÷0,5	PKE508*	2,6	1,4	8,0	14,0	○ white	10.000/500
0,75	PKE7508	2,8	1,6	8,0	14,0	● blue	10.000/500
1	PKE108*	3,0	1,8	8,0	14,0	● red	10.000/500
	PKE1508*	3,5	2,1	8,0	14,0		5.000/500
1,5	PKE1510*	3,5	2,1	10,0	16,0	● black	5.000/500
	PKE1518*	3,5	2,1	18,0	24,0		5.000/500
2,5	PKE2508	4,2	2,6	8,0	14,0	● grey	5.000/500
	PKE2512	4,2	2,6	12,0	18,0		4.000/500
	PKE2518	4,2	2,6	18,0	24,0		3.000/500
4	PKE410	4,8	3,3	10,0	18,0	● orange	3.000/200
	PKE412	4,8	3,3	12,0	20,0		3.000/200
	PKE418	4,8	3,3	18,0	26,0		3.000/200
6	PKE612	6,3	4,0	12,0	20,0	● green	1.500/100
	PKE618	6,3	4,0	18,0	26,0		1.500/100
10	PKE1012	7,6	5,0	12,0	22,0	● brown	1.000/100
	PKE1018	7,6	5,0	18,0	28,0		1.000/100
16	PKE1612	8,8	6,2	12,0	23,0	○ ivory	800/100
	PKE1618	8,8	6,2	18,0	29,0		1.000/100
25	PKE25016	11,2	7,9	16,0	30,0	● black	400/50
	PKE25022	11,2	7,9	22,0	36,0		400/50

*to DIN standard 46 228/4 *Not UL approved

PA6 INSULATED END SLEEVES

for flexible Copper conductors

PKC

Conductor Size sqmm	Type	Dimensions mm				Insulation Colour	Quantity Box/Bag
		Ø	B	P	L		
0,1÷0,3	PKC306*	1,9	1,1	6,0	10,0	light blue	20.000/500
	PKC308*	1,9	1,1	8,0	12,0	blue	20.000/500
0,3÷0,5	PKC508	2,6	1,4	8,0	14,0	orange	10.000/500
	PKC510	2,6	1,4	10,0	16,0	orange	10.000/500
0,75	PKC7508	2,8	1,6	8,0	14,0	white	10.000/500
	PKC7512	2,8	1,6	12,0	18,0	white	10.000/500
1	PKC108	3,0	1,8	8,0	14,0	yellow	10.000/500
	PKC112	3,0	1,8	12,0	18,0	yellow	7.500/500
1,5	PKC1508	3,5	2,1	8,0	14,0	red	5.000/500
	PKC1510	3,5	2,1	10,0	16,0	red	5.000/500
	PKC1518	3,5	2,1	18,0	24,0	red	5.000/500
2,5	PKC2508*	4,2	2,6	8,0	14,0	blue	5.000/500
	PKC2512*	4,2	2,6	12,0	18,0	blue	5.000/500
4	PKC2518*	4,2	2,6	18,0	24,0	blue	5.000/500
	PKC410*	4,8	3,3	10,0	18,0	grey	3.000/200
6	PKC412*	4,8	3,3	12,0	20,0	grey	3.000/200
	PKC418*	4,8	3,3	18,0	26,0	grey	3.000/200
10	PKC612	6,3	4,0	12,0	20,0	black	1.500/100
	PKC618	6,3	4,0	18,0	26,0	black	1.500/100
16	PKC1012	7,6	5,0	12,0	22,0	ivory	1.000/100
	PKC1018	7,6	5,0	18,0	28,0	ivory	1.000/100
25	PKC1612	8,8	6,2	12,0	23,0	green	800/100
	PKC1618	8,8	6,2	18,0	29,0	green	1.000/100
35	PKC25016	11,2	7,9	16,0	30,0	brown	400/50
	PKC25022	11,2	7,9	22,0	36,0	brown	500/50
50	PKC35016	12,7	8,9	16,0	30,0	beige	300/50
	PKC35025	12,7	8,9	25,0	39,0	beige	300/50
70	PKC50020	15,0	11,0	20,0	36,0	olive	200/50
	PKC50025	15,0	11,0	25,0	41,0	olive	200/50
95	PKC70022*	16,0	14,3	22,0	38,0	yellow	100/25
120	PKC95025*	18,0	15,7	25,0	44,0	red	100/25
120	PKC120027*	21,0	17,5	27,0	48,0	blue	100/25

*to DIN standard 46 228/4 *Not UL approved

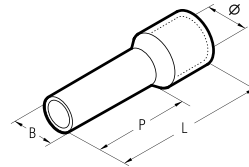

"TWIN" PA6 INSULATED END SLEEVES

for fine stranded conductors

PKT

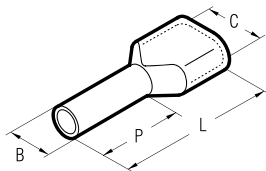

Conductor Size sqmm	Type	Dimensions mm				Insulation Colour	ND1,ND2,ND3, ND4 and HNKE 50 Compression Aperture	Quantity Box/Bag
		C	B	P	L			
2 x 0,5	PKT508	4,7x2,6	1,8	8,0	14,0	white	1	5.000/500
	PKT510*	4,7x2,6	1,8	10,0	18,0	white	1	5.000/500
2 x 0,75	PKT7508	5,0x2,8	2,1	8,0	15,0	grey	1,5	2.500/100
	PKT7510	5,0x2,8	2,1	10,0	17,0	grey	1,5	2.500/100
2 x 1	PKT108	5,4x3,4	2,4	8,0	16,0	red	2,5	2.500/100
	PKT110	5,4x3,4	2,4	10,0	18,0	red	2,5	2.500/100
2 x 1,5	PKT1508	6,6x3,6	2,6	8,0	16,0	black	2,5	2.500/100
	PKT1512	6,6x3,6	2,6	12,0	20,0	black	2,5	2.500/100
2 x 2,5	PKT2510	7,8x4,2	3,2	10,0	20,0	blue	4	2.000/100
	PKT2512	7,8x4,2	3,2	12,0	22,0	blue	4	1.500/100
2 x 4	PKT412	8,8x4,9	4,2	12,0	23,0	grey	6	1.000/100
2 x 6	PKT614	10,0x6,9	5,3	14,0	26,0	yellow	10	800/100
2 x 10	PKT1014*	13,3x7,5	6,2	12,0	24,0	red	16	500/50
2 x 16	PKT1614	18,6x9,6	8,9	14,0	30,0	blue	35	300/50

*Not UL approved



Type PKT range of end sleeves is manufactured from Tin plated electrolytic Copper.

Designed to accommodate two cables terminating in the same sleeve.

The operating temperature range is -20 to +115°C (Surge +130°C).

Recommended crimping tools are shown on pages 124 to 153, 159-160, 192, 194, 196, 257.

CPKD CPKC

POLYPROPYLENE INSULATED CHAIN END SLEEVES

for flexible Copper conductors



Conductor Size sqmm	Type	Dimensions mm				Insulation Colour	Quantity Box/Bag
		Ø	B	P	L		
0,3±0,5	CPKD508	2,6	1,3	8,0	14,0	○ white	5.000
0,75	CPKD7508	2,8	1,5	8,0	14,0	● grey	5.000
0,75	CPKC7508 NEW	2,8	1,5	8,0	14,0	○ white	5.000
1	CPKD108	3,0	1,7	8,0	14,0	● red	5.000
1,5	CPKD1508	3,5	2,0	8,0	14,0	● black	5.000
2,5	CPKD2508	4,2	2,5	8,0	14,0	● blue	3.000

Conforms to DIN standard 46228/4.



Interchangeable application heads are available for crimping these terminals with the bench press ELB-3 (see page 154).

UNINSULATED END SLEEVES

for flexible Copper conductors

KE

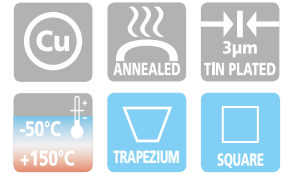
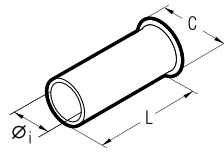

Conductor Size sqmm	Type	Dimensions mm			Quantity Box/Bag
		Ø	L	C	
0,5	KE506ST*	1,0	6,0	1,9	50.000/500
	KE508ST	1,0	8,0	1,9	50.000/500
0,75	KE7506ST*	1,2	6,0	2,2	40.000/500
	KE7508ST	1,2	8,0	2,2	40.000/500
1	KE106ST*	1,4	6,0	2,4	25.000/500
	KE110ST*	1,4	10,0	2,4	25.000/500
1,5	KE1508ST	1,7	8,0	2,8	25.000/500
	KE1510ST*	1,7	10,0	2,8	25.000/500
2,5	KE2508ST	2,2	8,0	3,4	20.000/500
	KE2510ST*	2,2	10,0	3,4	15.000/500
4	KE410ST	2,8	10,0	4,0	12.500/500
	KE412ST*	2,8	12,0	4,0	10.000/500
6	KE610ST*	3,5	10,0	4,7	10.000/500
	KE612ST*	3,5	12,0	4,7	7.500/500
	KE616ST*	3,5	15,0	4,7	5.000/500
10	KE1016ST*	4,5	15,0	5,8	4.000/250
16	KE1616ST*	5,8	15,0	7,5	3.000/250
25	KE25015ST	7,3	15,0	9,5	1.500/100
	KE25018ST*	7,3	18,0	9,5	1.500/100
35	KE35012ST	8,3	12,0	10,5	1.500/100
	KE35015ST	8,3	16,0	10,5	1.500/100
	KE35018ST*	8,3	18,0	10,5	1.000/100

*to DIN standard 46 228/1

KE series end sleeves are manufactured from Tin plated electrolytic Copper of grade CW024A according to EN 12449, with purity greater than 99%. The compact geometry of the range allows for the termination of flexible conductors in confined spaces.

Recommended crimping tools are shown on pages 124 to 153, 159-160, 192, 194, 196, 257.

S

UNINSULATED TERMINALS

S range - brazed seam - for Copper conductors



S range terminals are manufactured from electrolytic Copper strip with a purity greater than 99.9% and Tin plated.

The seam is brazed to provide uniform mechanical strength. The terminal barrel is rifled to enhance electrical contact and to improve mechanical strength.

Recommended crimping tools are shown on pages 124 to 151, 192.

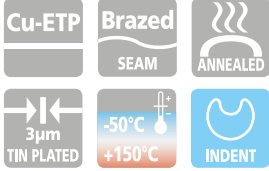

pin terminals

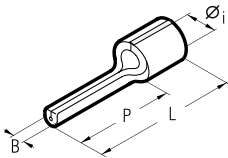

Conductor Size sqmm (AWG)	Type	Dimensions mm				Quantity Box/Bag
		Øi	B	P	L	
0,25÷1,5 [22÷16]	S1.5-P8	1,8	1,6	8,0	12,0	8.000/100
	S1.5-P10	1,8	1,6	10,0	14,0	8.000/100
	S1.5-P12	1,8	1,6	12,0	16,2	8.000/100
1,5÷2,5 [16÷14]	S2.5-P8	2,4	1,6	8,0	12,0	7.000/100
	S2.5-P10	2,4	1,6	10,0	14,0	7.000/100
	S2.5-P12	2,4	1,6	12,0	16,0	7.000/100
4÷6 [12÷10]	S6-P10	3,6	2,2	10,0	16,8	4.000/100
	S6-P12	3,6	2,2	12,0	19,0	4.000/100
	S6-P14	3,6	2,2	14,0	21,0	3.500/100

blade terminals

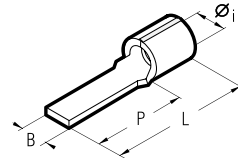

Conductor Size sqmm (AWG)	Type	Dimensions mm				Quantity Box/Bag
		Øi	B	P	L	
0,25÷1,5 [22÷16]	S1.5-PP12	1,8	3,0	12,8	17,0	8.000/100
	S1.5-PP12/1*	1,8	3,0	11,3	15,5	8.000/100
	S1.5-PP12/19	1,8	1,9	13,2	17,4	8.000/100
	S1.5-PP14	1,8	3,0	14,8	19,0	8.000/100
1,5÷2,5 [16÷14]	S2.5-PP12	2,4	3,5	12,8	17,0	7.000/100
	S2.5-PP12/25	2,4	2,5	13,3	17,5	7.000/100
	S2.5-PP16/25	2,4	2,5	17,2	21,4	7.000/100
4÷6 [12÷10]	S6-PP12	3,6	4,0	13,3	19,7	4.000/100
	S6-PP17	3,6	2,9	19,1	25,5	4.000/100

*Made to order

UNINSULATED TERMINALS

S

S range - brazed seam - for Copper conductors

ring terminals

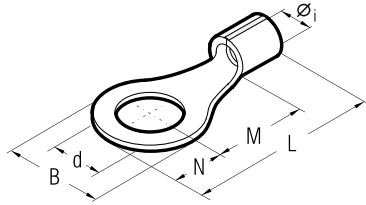

fork/spade terminals

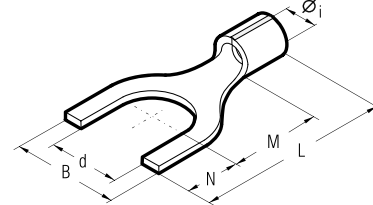

Conductor Size sqmm (AWG)	Ø Stud mm	Type	Dimensions mm						Quantity Box/Bag
			Øi	B	M	N	L	d	
0,25÷1,5 [22÷16]	2	S1.5-M2*	1,8	5,6	4,5	2,8	11,5	2,2	7.000/100
	3	S1.5-M3	1,8	5,6	4,5	2,8	11,5	3,2	7.000/100
	3,5	S1.5-M3.5	1,8	5,6	4,5	2,8	11,5	3,7	7.000/100
	3,5	S1.5-M3.5/1*	1,8	6,2	7,1	3,1	14,4	3,7	7.000/100
	4	S1.5-M4	1,8	7,0	6,5	3,5	14,2	4,3	7.000/100
	4	S1.5-M4/3*	1,8	7,8	7,1	3,9	15,2	4,3	7.000/100
	5	S1.5-M5	1,8	7,8	7,1	3,9	15,2	5,3	7.000/100
	6	S1.5-M6	1,8	9,4	8,1	4,7	17,0	6,4	6.000/100
	6	S1.5-M6/1	1,8	12,0	10,3	6,0	20,5	6,4	5.000/100
	7	S1.5-M7	1,8	9,4	8,1	4,7	17,0	7,2	6.000/100
	8	S1.5-M8	1,8	12,0	10,3	6,0	20,5	8,4	4.000/100
	10	S1.5-M10	1,8	15,5	13,0	7,7	25,0	10,5	3.000/100
12	S1.5-M12	1,8	18,0	15,5	9,0	28,7	13,0	2.000/100	
1,5÷2,5 [16÷14]	3	S2.5-M3	2,4	5,6	5,0	2,8	12,0	3,2	6.000/100
	3,5	S2.5-M3.5	2,4	5,6	5,0	2,8	12,0	3,7	6.000/100
	3,5	S2.5-M3.5/1*	2,4	6,2	6,5	3,1	13,8	3,7	5.000/100
	4	S2.5-M4	2,4	8,0	6,5	4,0	14,7	4,3	5.000/100
	5	S2.5-M5	2,4	8,0	7,5	4,0	15,7	5,3	5.000/100
	6	S2.5-M6	2,4	9,4	8,6	4,7	17,5	6,4	5.000/100
	6	S2.5-M6/1	2,4	12,0	10,3	6,0	20,5	6,4	5.000/100
	7	S2.5-M7	2,4	10,0	7,8	5,0	17,0	7,2	5.000/100
	8	S2.5-M8	2,4	12,0	10,3	6,0	20,5	8,4	4.000/100
	10	S2.5-M10	2,4	15,5	13,0	7,7	25,0	10,5	2.500/100
	12	S2.5-M12	2,4	18,0	15,5	9,0	28,7	13,0	2.000/100
	4÷6 [12÷10]	3	S6-M3	3,6	8,0	8,1	4,0	18,5	3,2
3,5		S6-M3.5	3,6	8,0	8,1	4,0	18,5	3,7	3.000/100
4		S6-M4	3,6	9,0	8,1	4,5	19,0	4,3	3.000/100
5		S6-M5	3,6	9,0	8,1	4,5	19,0	5,3	2.500/100
6		S6-M6	3,6	11,0	11,1	5,5	23,0	6,4	2.500/100
6		S6-M6/1*	3,6	11,0	8,1	5,5	20,0	6,4	2.500/100
7		S6-M7	3,6	11,0	11,1	5,5	23,0	7,2	2.500/100
8		S6-M8	3,6	13,6	12,1	6,8	25,3	8,4	2.000/100
8		S6-M8/1*	3,6	11,0	8,1	5,5	20,0	8,4	2.500/100
10		S6-M10	3,6	13,6	12,1	6,8	25,3	10,5	2.000/100
10		S6-M10/1	3,6	15,5	13,8	7,7	28,0	10,5	2.000/100
12		S6-M12	3,6	19,0	15,1	9,5	31,0	13,0	1.000/100
14	S6-M14	3,6	21,0	16,1	10,5	33,0	15,0	1.000/100	
16	S6-M16	3,6	24,0	17,1	12,0	35,5	17,0	1.000/100	
10 (8)	4	S10-M4	4,8	11,5	9,0	5,8	23,8	4,3	2.000/100
	5	S10-M5	4,8	11,5	9,0	5,8	23,8	5,3	2.000/100
	6	S10-M6	4,8	11,5	9,0	5,8	23,8	6,4	2.000/100
	7	S10-M7	4,8	11,5	9,0	5,8	23,8	7,2	1.500/100

Conductor Size sqmm (AWG)	Ø Stud mm	Type	Dimensions mm						Quantity Box/Bag
			Øi	B	M	N	L	d	
0,25÷1,5 [22÷16]	3	S1.5-U3	1,8	5,5	5,5	4,0	13,7	3,2	7.000/100
	3,5	S1.5-U3.5	1,8	6,0	6,5	3,8	14,5	3,7	7.000/100
	3,5	S1.5-U3.5/2*	1,8	6,4	6,5	3,8	14,5	3,7	7.000/100
	4	S1.5-U4	1,8	6,5	7,5	3,7	15,4	4,3	7.000/100
	4	S1.5-U4/1*	1,8	8,5	7,5	3,7	15,4	4,3	7.000/100
	4	S1.5-U4/2	1,8	7,5	7,5	3,7	15,4	4,3	7.000/100
	5	S1.5-U5	1,8	8,5	7,5	3,7	15,4	5,3	7.000/100
	5	S1.5-U5/1	1,8	9,4	7,5	3,7	15,4	5,3	7.000/100
	6	S1.5-U6	1,8	9,4	8,1	4,7	17,0	6,4	6.000/100
	6	S1.5-U6/1*	1,8	12,0	9,2	7,1	20,5	6,4	6.000/100
	8	S1.5-U8	1,8	14,0	10,0	6,3	20,5	8,4	3.000/100
	10	S1.5-U10	1,8	17,5	13,0	7,7	25,0	10,5	2.500/100
12	S1.5-U12	1,8	20,0	15,5	9,0	28,7	13,0	2.000/100	
1,5÷2,5 [16÷14]	3	S2.5-U3	2,4	5,5	5,5	4,0	13,7	3,2	6.000/100
	3,5	S2.5-U3.5	2,4	6,4	6,5	3,8	14,5	3,7	6.000/100
	3,5	S2.5-U3.5/1*	2,4	7,2	6,5	3,8	14,5	3,7	6.000/100
	4	S2.5-U4	2,4	6,5	7,5	3,7	15,4	4,3	5.000/100
	4	S2.5-U4/1*	2,4	8,5	7,5	3,7	15,4	4,3	6.000/100
	4	S2.5-U4/2*	2,4	7,5	7,5	3,7	15,4	4,3	6.000/100
	5	S2.5-U5	2,4	8,5	7,5	3,7	15,4	5,3	6.000/100
	6	S2.5-U6	2,4	9,4	8,1	4,7	17,0	6,4	5.000/100
	6	S2.5-U6/1*	2,4	12,0	9,2	7,1	20,5	6,4	4.000/100
	8	S2.5-U8	2,4	14,0	10,0	6,3	20,5	8,4	2.500/100
	10	S2.5-U10	2,4	17,5	13,0	7,7	25,0	10,5	2.000/100
	12	S2.5-U12	2,4	20,0	15,5	9,0	28,7	13,0	2.000/100
4÷6 [12÷10]	3,5	S6-U3.5	3,6	7,5	8,5	3,9	18,8	3,7	3.000/100
	4	S6-U4	3,6	7,5	8,0	4,4	18,8	4,3	3.000/100
	5	S6-U5	3,6	9,5	8,0	4,4	18,8	5,3	2.500/100
	6	S6-U6	3,6	10,0	11,0	5,5	22,9	6,4	2.500/100
	8	S6-U8	3,6	13,5	12,0	8,0	26,4	8,4	2.000/100
	10	S6-U10	3,6	15,5	13,0	8,0	27,4	10,5	2.000/100
	10	S6-U10/1*	3,6	17,5	13,8	7,7	28,0	10,5	2.000/100
	12	S6-U12	3,6	21,0	15,1	9,5	31,0	13,0	1.000/100
	14	S6-U14	3,6	23,0	16,1	10,5	33,0	15,0	1.000/100
	16	S6-U16*	3,6	26,0	17,1	11,5	35,0	17,0	1.000/100

*Made to order

RN, BN, GN range - unbraced - for Copper conductors



RN, BN, GN range terminals are manufactured from electrolytic Copper strip with a purity greater than 99.9% and Tin plated. The seam is unbraced.

The terminal barrel is rifled to enhance electrical contact and to improve mechanical strength.

Recommended crimping tools are shown on pages 124 to 151, 192.

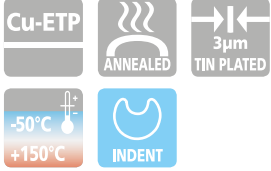

pin terminals

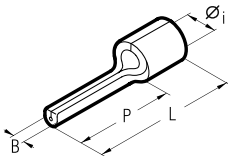

blade terminals

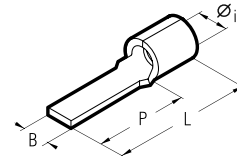

Conductor Size sqmm (AWG)	Type	Dimensions mm				Quantity Box/Bag
		Øi	B	P	L	
0,25÷1,5 [22÷16]	RN-P8	1,8	1,6	8,0	12,0	8.000/100
	RN-P10	1,8	1,6	10,0	14,0	8.000/100
	RN-P12	1,8	1,6	12,0	16,2	8.000/100
1,5÷2,5 [16÷14]	BN-P8	2,4	1,6	8,0	12,0	7.000/100
	BN-P10	2,4	1,6	10,0	14,0	7.000/100
	BN-P12	2,4	1,6	12,0	16,0	7.000/100
4÷6 [12÷10]	GN-P10	3,6	2,2	10,0	16,8	4.000/100
	GN-P12	3,6	2,2	12,0	19,0	4.000/100
	GN-P14	3,6	2,2	14,0	21,0	3.500/100

Conductor Size sqmm (AWG)	Type	Dimensions mm				Quantity Box/Bag
		Øi	B	P	L	
0,25÷1,5 [22÷16]	RN-PP12	1,8	3,0	12,8	17,0	8.000/100
	RN-PP12/1	1,8	3,0	11,3	15,5	8.000/100
	RN-PP12/19	1,8	1,9	13,2	17,4	8.000/100
	RN-PP14	1,8	3,0	14,8	19,0	8.000/100
	RN-PP16/23	1,8	2,3	17,2	21,4	8.000/100
1,5÷2,5 [16÷14]	BN-PP12	2,4	3,5	12,8	17,0	7.000/100
	BN-PP12/25	2,4	2,5	13,3	17,5	7.000/100
	BN-PP16/25	2,4	2,5	17,2	21,4	7.000/100
4÷6 [12÷10]	GN-PP12	3,6	4,0	13,3	19,7	4.000/100
	GN-PP17	3,6	2,9	19,1	25,5	4.000/100

RN, BN, GN range - unbraced - for Copper conductors

ring terminals

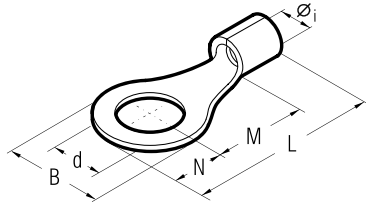

Conductor Size sqmm (AWG)	Ø Stud mm	Type	Dimensions mm						Quantity Box/Bag
			Øi	B	M	N	L	d	
0,25÷1,5 (22÷16)	2	RN-M2*	1,8	5,6	4,5	2,8	11,5	2,2	7.000/100
	3	RN-M3	1,8	5,6	4,5	2,8	11,5	3,2	7.000/100
	3,5	RN-M3.5	1,8	5,6	4,5	2,8	11,5	3,7	7.000/100
	3,5	RN-M3.5/1	1,8	6,2	7,1	3,1	14,4	3,7	7.000/100
	4	RN-M4	1,8	7,0	6,5	3,5	14,2	4,3	7.000/100
	4	RN-M4/3	1,8	7,8	7,1	3,9	15,2	4,3	7.000/100
	5	RN-M5	1,8	7,8	7,1	3,9	15,2	5,3	7.000/100
	6	RN-M6	1,8	9,4	8,1	4,7	17,0	6,4	6.000/100
	6	RN-M6/1	1,8	12,0	10,3	6,0	20,5	6,4	4.000/100
	7	RN-M7	1,8	9,4	8,1	4,7	17,0	7,2	6.000/100
	8	RN-M8	1,8	12,0	10,3	6,0	20,5	8,4	4.000/100
	10	RN-M10	1,8	15,5	13,0	7,7	25,0	10,5	2.000/100
12	RN-M12	1,8	18,0	15,5	9,0	28,7	13,0	2.000/100	
1,5÷2,5 (16÷14)	2	BN-M2*	2,4	5,6	5,0	2,8	12,0	2,2	6.000/100
	3	BN-M3	2,4	5,6	5,0	2,8	12,0	3,2	6.000/100
	3,5	BN-M3.5	2,4	5,6	5,0	2,8	12,0	3,7	6.000/100
	3,5	BN-M3.5/1	2,4	6,2	6,5	3,1	13,8	3,7	6.000/100
	4	BN-M4	2,4	8,0	6,5	4,0	14,7	4,3	5.000/100
	5	BN-M5	2,4	8,0	7,5	4,0	15,7	5,3	5.000/100
	6	BN-M6	2,4	9,4	8,6	4,7	17,5	6,4	5.000/100
	6	BN-M6/1	2,4	12,0	10,3	6,0	20,5	6,4	5.000/100
	7	BN-M7	2,4	10,0	7,8	5,0	17,0	7,2	5.000/100
	8	BN-M8	2,4	12,0	10,3	6,0	20,5	8,4	4.000/100
	10	BN-M10	2,4	15,5	13,0	7,7	25,0	10,5	2.500/100
	12	BN-M12	2,4	18,0	15,5	9,0	28,7	13,0	2.000/100
4÷6 (12÷10)	3	GN-M3	3,6	8,0	8,1	4,0	18,5	3,2	3.000/100
	3,5	GN-M3.5	3,6	8,0	8,1	4,0	18,5	3,7	3.000/100
	4	GN-M4	3,6	9,0	8,1	4,5	19,0	4,3	3.000/100
	5	GN-M5	3,6	9,0	8,1	4,5	19,0	5,3	2.500/100
	6	GN-M6	3,6	11,0	11,1	5,5	23,0	6,4	2.500/100
	6	GN-M6/1	3,6	11,0	8,1	5,5	20,0	6,4	2.500/100
	7	GN-M7	3,6	11,0	11,1	5,5	23,0	7,2	2.500/100
	8	GN-M8	3,6	13,6	12,1	6,8	25,3	8,4	2.000/100
	8	GN-M8/1*	3,6	11,0	8,1	5,5	20,0	8,4	2.500/100
	10	GN-M10	3,6	13,6	12,1	6,8	25,3	10,5	2.000/100
	10	GN-M10/1	3,6	15,5	13,8	7,7	28,0	10,5	2.000/100
	12	GN-M12	3,6	19,0	15,1	9,5	31,0	13,0	1.000/100
14	GN-M14	3,6	21,0	16,1	10,5	33,0	15,0	1.000/100	
16	GN-M16	3,6	24,0	17,1	12,0	35,5	17,0	1.000/100	

fork/spade terminals

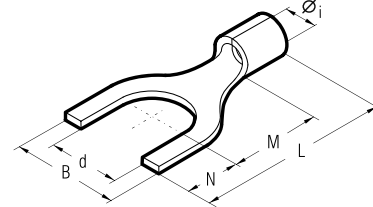

Conductor Size sqmm (AWG)	Ø Stud mm	Type	Dimensions mm						Quantity Box/Bag
			Øi	B	M	N	L	d	
0,25÷1,5 (22÷16)	3	RN-U3	1,8	5,5	5,5	4,0	13,7	3,2	7.000/100
	3,5	RN-U3.5	1,8	6,0	6,5	3,8	14,5	3,7	7.000/100
	3,5	RN-U3.5/2	1,8	6,4	6,5	3,8	14,5	3,7	7.000/100
	4	RN-U4	1,8	6,5	7,5	3,7	15,4	4,3	7.000/100
	4	RN-U4/1	1,8	8,5	7,5	3,7	15,4	4,3	7.000/100
	4	RN-U4/2	1,8	7,5	7,5	3,7	15,4	4,3	7.000/100
	5	RN-U5	1,8	8,5	7,5	3,7	15,4	5,3	5.000/100
	5	RN-U5/1*	1,8	9,4	7,5	3,7	15,4	5,3	5.000/100
	6	RN-U6	1,8	9,4	8,1	4,7	17,0	6,4	6.000/100
	6	RN-U6/1	1,8	12,0	9,2	7,1	20,5	6,4	3.000/100
	8	RN-U8	1,8	14,0	10,0	6,3	20,5	8,4	2.500/100
	10	RN-U10	1,8	17,5	13,0	7,7	25,0	10,5	2.000/100
12	RN-U12	1,8	20,0	15,5	9,0	28,7	13,0	2.000/100	
1,5÷2,5 (16÷14)	3	BN-U3	2,4	5,5	5,5	4,0	13,7	3,2	6.000/100
	3,5	BN-U3.5	2,4	6,4	6,5	3,8	14,5	3,7	6.000/100
	3,5	BN-U3.5/1*	2,4	7,2	6,5	3,8	14,5	3,7	6.000/100
	4	BN-U4	2,4	6,5	7,5	3,7	15,4	4,3	6.000/100
	4	BN-U4/1	2,4	8,5	7,5	3,7	15,4	4,3	6.000/100
	4	BN-U4/2	2,4	7,5	7,5	3,7	15,4	4,3	6.000/100
	5	BN-U5	2,4	8,5	7,5	3,7	15,4	5,3	5.000/100
	6	BN-U6	2,4	9,4	8,1	4,7	17,0	6,4	5.000/100
	6	BN-U6/1	2,4	12,0	9,2	7,1	20,5	6,4	4.000/100
	8	BN-U8	2,4	14,0	10,0	6,3	20,5	8,4	4.000/100
	10	BN-U10	2,4	17,5	13,0	7,7	25,0	10,5	2.000/100
	12	BN-U12	2,4	20,0	15,5	9,0	28,7	13,0	2.000/100
4÷6 (12÷10)	3,5	GN-U3.5	3,6	7,5	8,5	3,9	18,8	3,7	3.000/100
	4	GN-U4	3,6	7,5	8,0	4,4	18,8	4,3	3.000/100
	5	GN-U5	3,6	9,5	8,0	4,4	18,8	5,3	2.500/100
	6	GN-U6	3,6	10,0	11,0	5,5	22,9	6,4	2.500/100
	8	GN-U8	3,6	13,5	12,0	8,0	26,4	8,4	2.000/100
	10	GN-U10	3,6	15,5	13,0	8,0	27,4	10,5	2.000/100
	10	GN-U10/1	3,6	17,5	13,8	7,7	28,0	10,5	2.000/100
	12	GN-U12	3,6	21,0	15,1	9,5	31,0	13,0	1.000/100
	14	GN-U14	3,6	23,0	16,1	10,5	33,0	15,0	1.000/100
	16	GN-U16	3,6	26,0	17,1	11,5	35,0	17,0	1.000/100

*Made to order



CRIMPING CONNECTORS ACCORDING TO DIN 46234

for Copper conductors

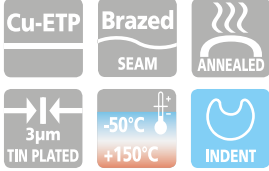
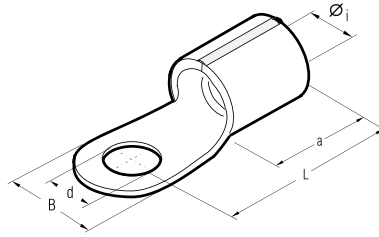

Q type connectors are manufactured from electrolytic Copper strip with a purity greater than 99.9%, annealed and surface protected by tin plating; dimensions are compliant with DIN 46234; the sleeve is brazed with a silver-Copper alloy.

Details of the conductor csa and stud diameter are engraved on the palm.

Details of the appropriate crimping tools and dies are shown on page 268.

Consult us for special requirements.

Conductor Size sqmm	Ø Stud mm	Type	Dimensions mm					Quantity Box/Bag	Mechanical Tools	Hydraulic Tools			
			Øi	d	L	B	a						
6÷10	4	Q10-4	4,5	4,3	16,0	10,0	8,0	1.500/100	HNS*	HT51D RH50 RHM50 B500ND HT81-JD RHU81D	RH60C B600C B600CND	HT120 and tools and heads with 130 kN crimping force	ECW-H3D
	5	Q10-5	4,5	5,3	16,0	10,0	8,0	1.500/100					
	6	Q10-6	4,5	6,5	17,0	11,0	8,0	1.000/100					
	8	Q10-8	4,5	8,4	20,0	14,0	8,0	1.000/100					
	10	Q10-10	4,5	10,5	21,0	18,0	8,0	1.000/100					
10÷16	12	Q10-12	4,5	13,0	22,0	22,0	8,0	500/100					
	5	Q16-5	5,8	5,3	20,0	11,0	10,0	1.000/100					
	6	Q16-6	5,8	6,5	20,0	11,0	10,0	1.000/100					
	8	Q16-8	5,8	8,4	22,0	14,0	10,0	500/100					
	10	Q16-10	5,8	10,5	24,0	18,0	10,0	500/100					
16÷25	12	Q16-12	5,8	13,0	26,0	22,0	10,0	500/100					
	5	Q25-5	7,5	5,3	25,0	12,0	11,0	500/100					
	6	Q25-6	7,5	6,5	25,0	12,0	11,0	500/100					
	8	Q25-8	7,5	8,4	25,0	16,0	11,0	500/100					
	10	Q25-10	7,5	10,5	26,0	18,0	11,0	500/100					
25÷35	12	Q25-12	7,5	13,0	31,0	22,0	11,0	500/100					
	16	Q25-16	7,5	17,0	35,0	28,0	11,0	200/100					
	6	Q35-6	9,0	6,5	26,0	15,0	12,0	400/100					
	8	Q35-8	9,0	8,4	26,0	16,0	12,0	400/100					
	10	Q35-10	9,0	10,5	27,0	18,0	12,0	300/100					
35÷50	12	Q35-12	9,0	13,0	31,0	22,0	12,0	250/50					
	16	Q35-16	9,0	17,0	36,0	28,0	12,0	200/50					
	6	Q50-6	11,0	6,5	34,0	18,0	16,0	200/50					
	8	Q50-8	11,0	8,4	34,0	18,0	16,0	200/50					
	10	Q50-10	11,0	10,5	34,0	18,0	16,0	200/50					
50÷70	12	Q50-12	11,0	13,0	36,0	22,0	16,0	200/50					
	16	Q50-16	11,0	17,0	40,0	28,0	16,0	200/50					
	6	Q70-6	13,0	6,5	38,0	22,0	18,0	100/50					
	8	Q70-8	13,0	8,4	38,0	22,0	18,0	100/50					
	10	Q70-10	13,0	10,5	38,0	22,0	18,0	100/50					
70÷95	12	Q70-12	13,0	13,0	38,0	22,0	18,0	100/50					
	16	Q70-16	13,0	17,0	42,0	28,0	18,0	100/50					
	8	Q95-8	15,0	8,4	42,0	24,0	20,0	100/25					
	10	Q95-10	15,0	10,5	42,0	24,0	20,0	100/25					
70÷95	12	Q95-12	15,0	13,0	44,0	24,0	20,0	100/25					
	16	Q95-16	15,0	17,0	70,0	28,0	20,0	100/25					

CRIMPING CONNECTORS ACCORDING TO DIN 46234

for Copper conductors

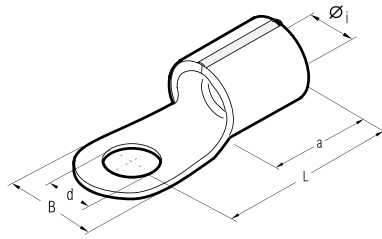

Conductor Size sqmm	Ø Stud mm	Type	Dimensions mm					Quantity Box/Bag	Hydraulic Tools	
			Øi	d	L	B	a		HT120 and tools and heads with 130 kN crimping force	ECW-H3D
95÷120	8	Q120-8	16,5	8,4	44,0	24,0	22,0	100/25		
	10	Q120-10	16,5	10,5	44,0	24,0	22,0	100/25		
	12	Q120-12	16,5	13,0	44,0	24,0	22,0	100/25		
	16	Q120-16	16,5	17,0	48,0	28,0	22,0	50/25		
120:150	10	Q150-10	19,0	10,5	50,0	30,0	24,0	50/25		
	12	Q150-12	19,0	13,0	50,0	30,0	24,0	50/25		
	16	Q150-16	19,0	17,0	50,0	30,0	24,0	50/25		
150÷185	10	Q185-10	21,0	10,5	50,0	36,0	28,0	40/20		
	12	Q185-12	21,0	13,0	50,0	36,0	28,0	40/20		
	16	Q185-16	21,0	17,0	50,0	36,0	28,0	30/15		
185÷240	10	Q240-10	23,5	10,5	56,0	38,0	32,0	10/10		
	12	Q240-12	23,5	13,0	56,0	38,0	32,0	10/10		
	16	Q240-16	23,5	17,0	56,0	38,0	32,0	10/10		

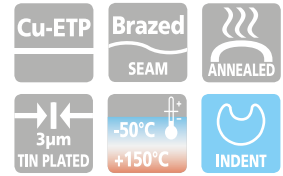

Consult us for special requirements.

Consult us for further information.

A-M

COPPER TUBE CRIMPING LUGS

for Copper conductors

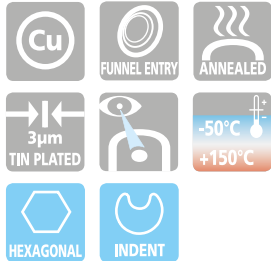
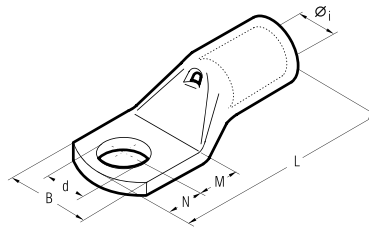

A-M series lugs are manufactured from electrolytic Copper tube with a purity greater than 99.9%.

The dimensions of the tube are designed to obtain the most efficient electrical conductivity and mechanical strength to resist vibration and pull out.

Cembre lugs are annealed to guarantee optimum ductility which is an absolute necessity for connectors which will have to withstand the severe deformation arising when compressed and any bending of the palm during installation. In applications subject to vibration, lugs still have to provide a reliable connection and annealing plays a vital role in avoiding cracking or breaks between the barrel and palm.

The presence of an inspection hole facilitates full insertion of the conductor, whilst the barrel length has been designed to allow easy and accurate positioning of the dies during the crimping operation.

Lugs are electrolytically Tin plated to avoid oxidation. A-M series lugs form an important part of Cembre crimping systems for power carrying conductors, details of the appropriate crimping tools and dies are shown opposite and in detail on pages 260 to 261.

Our technicians are always available to provide any technical advice which may be required.

The enclosed table is only indicative of the range and many variations in stud fixing and palm lengths are also available.

Conductor Size sqmm	Ø Stud mm	Type	Dimensions mm						Quantity Box/Bag	Mechanical Tools	Hydraulic Tools
			Øi	B	M	N	L	d			
0,25÷1,5	3	A03-M3*	1,8	6,0	4,5	3,5	16,0	3,2	5.000/100	HN1	BT15MD
	3,5	A03-M3.5*	1,8	6,5	4,5	3,5	16,0	3,7	5.000/100		
	4	A03-M4*	1,8	6,5	5,0	4,0	17,0	4,3	5.000/100		
	5	A03-M5*	1,8	7,5	5,5	4,5	18,0	5,3	5.000/100		
	6	A03-M6*	1,8	9,0	6,0	5,0	19,0	6,4	5.000/100		
	3	A06-M3*	2,4	6,0	4,5	3,5	17,0	3,2	4.000/100		
1,5÷2,5	3,5	A06-M3.5*	2,4	6,5	4,5	3,5	17,0	3,7	4.000/100		
	4	A06-M4*	2,4	7,5	5,0	4,0	18,0	4,3	4.000/100		
	5	A06-M5*	2,4	8,5	5,5	4,5	19,0	5,3	4.000/100		
	6	A06-M6*	2,4	9,0	6,0	5,0	20,0	6,4	4.000/100		
	8	A06-M8*	2,4	12,0	9,0	8,0	26,0	8,4	2.500/100		
	3	A1-M3	3,6	7,5	4,5	3,5	20,5	3,2	2.000/100		
4÷6	3,5	A1-M3.5	3,6	7,5	4,5	3,5	20,5	3,7	2.000/100		
	4	A1-M4	3,6	8,0	5,0	4,0	21,5	4,3	2.000/100		
	5	A1-M5	3,6	9,0	6,5	6,0	25,0	5,3	2.000/100		
	6	A1-M6	3,6	11,0	7,0	6,0	25,5	6,4	1.500/100		
	8	A1-M8	3,6	14,0	9,0	8,0	29,5	8,4	1.500/100		
	10	A1-M10	3,6	16,5	11,0	10,0	34,0	10,5	1.000/100		
10	4	A2-M4	4,6	10,0	5,0	4,0	22,5	4,3	1.500/100		
	5	A2-M5	4,6	10,0	6,5	6,0	26,0	5,3	1.000/100		
	6	A2-M6	4,6	11,0	7,0	6,0	26,5	6,4	1.000/100		
	8	A2-M8	4,6	15,0	9,0	8,0	30,5	8,4	1.000/100		
	10	A2-M10	4,6	18,0	11,0	10,0	34,5	10,5	500/100		
	12	A2-M12	4,6	19,0	14,0	12,0	39,5	13,2	500/100		
16	4	A3-M4	5,8	11,5	5,0	4,0	25,5	4,3	1.000/100		
	5	A3-M5	5,8	11,5	6,5	6,0	29,0	5,3	1.000/100		
	6	A3-M6	5,8	11,5	7,0	6,0	29,5	6,4	1.000/100		
	8	A3-M8	5,8	15,0	9,0	8,0	33,5	8,4	500/100		
	10	A3-M10	5,8	18,0	11,0	10,0	37,5	10,5	500/100		
	12	A3-M12	5,8	20,0	14,0	12,0	44,0	13,2	500/100		
25	4	A5-M4	7,0	14,0	5,0	4,0	28,0	4,3	500/100		
	5	A5-M5	7,0	14,0	6,5	6,0	31,5	5,3	500/100		
	6	A5-M6	7,0	14,0	7,0	6,0	32,0	6,4	500/100		
	8	A5-M8	7,0	15,0	9,0	8,0	36,0	8,4	500/100		
	10	A5-M10	7,0	18,0	11,0	10,0	40,0	10,5	500/100		
	12	A5-M12	7,0	21,0	14,0	12,0	45,0	13,2	400/100		
35	5	A7-M5	8,9	17,0	6,5	6,0	34,0	5,3	400/100		
	6	A7-M6	8,9	17,0	7,0	6,0	34,5	6,4	400/100		
	8	A7-M8	8,9	17,0	9,0	8,0	38,5	8,4	400/100		
	10	A7-M10	8,9	19,0	11,0	10,0	42,5	10,5	300/100		
	12	A7-M12	8,9	21,0	14,0	12,0	47,5	13,2	200/50		
	6	A10-M6	10,0	19,0	8,0	7,0	38,5	6,4	200/50		
50	8	A10-M8	10,0	19,0	9,0	8,0	40,5	8,4	200/50		
	10	A10-M10	10,0	20,0	11,5	9,5	44,5	10,5	200/50		
	12	A10-M12	10,0	21,0	12,0	12,0	47,5	13,2	200/50		
	14	A10-M14	10,0	25,0	16,0	14,0	55,5	15,0	200/50		
	16	A10-M16	10,0	26,0	18,0	16,0	59,5	17,0	100/50		
	6	A14-M6	11,3	21,0	8,0	7,0	44,0	6,4	200/50		
70	8	A14-M8	11,3	21,0	9,0	8,0	46,0	8,4	200/50		
	10	A14-M10	11,3	21,0	11,0	10,0	50,0	10,5	200/50		
	12	A14-M12	11,3	22,0	14,0	12,0	55,0	13,2	150/50		
	14	A14-M14	11,3	25,0	16,0	14,0	59,0	15,0	100/50		
	16	A14-M16	11,3	26,0	18,0	16,0	63,0	17,0	100/50		

*Not UL approved

COPPER TUBE CRIMPING LUGS

for Copper conductors

A-M

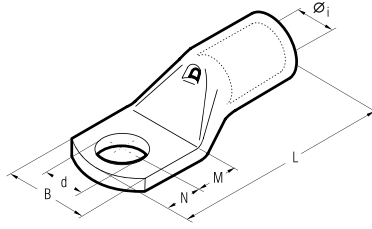

Conductor Size sqmm	Ø Stud mm	Type	Dimensions mm							Quantity Box/Bag	Mechanical Tools	Hydraulic Tools	
			Øi	B	M	N	L	d	HT45-E			B450ND-BV	
95	70 95	6 A19-M6	13,5	25,0	8,0	7,0	50,5	6,4	100/25	TINI 205E**	HT45-E	B450ND-BV	
		8 A19-M8	13,5	25,0	9,0	8,0	52,5	8,4	100/25				
		10 A19-M10	13,5	25,0	11,0	10,0	56,5	10,5	100/25				
		12 A19-M12	13,5	25,0	14,0	12,0	61,5	13,2	100/25				
		14 A19-M14	13,5	25,0	16,0	14,0	65,5	15,0	100/25				
		16 A19-M16	13,5	27,0	18,0	16,0	69,5	17,0	50/25				
		20 A19-M20	13,5	29,5	22,0	20,0	77,5	21,0	50/25				
120	95 120	8 A24-M8	15,2	28,5	9,0	8,0	54,0	8,4	75/25				
		10 A24-M10	15,2	28,5	11,0	10,0	58,0	10,5	75/25				
		12 A24-M12	15,2	28,5	14,0	12,0	63,0	13,2	75/25				
		14 A24-M14	15,2	28,5	16,0	14,0	67,0	15,0	50/25				
		16 A24-M16	15,2	28,5	18,0	16,0	71,0	17,0	50/25				
		20 A24-M20	15,2	30,0	22,0	20,0	79,0	21,0	50/25				
150	120 150	8 A30-M8	16,7	31,5	13,0	11,0	69,0	8,4	50/25				
		10 A30-M10	16,7	31,5	13,0	11,0	69,0	10,5	50/25				
		12 A30-M12	16,7	31,5	16,0	14,0	75,0	13,2	50/25				
		14 A30-M14	16,7	31,5	18,0	16,0	79,0	15,0	50/25				
		16 A30-M16	16,7	31,5	19,0	17,0	81,0	17,0	50/25				
		20 A30-M20	16,7	31,5	22,0	20,0	87,0	21,0	50/25				
185	150 185	8 A37-M8	19,2	35,5	13,0	11,0	76,0	8,4	30/15				
		10 A37-M10	19,2	35,5	13,0	11,0	76,0	10,5	30/15				
		12 A37-M12	19,2	35,5	16,0	14,0	82,0	13,2	30/15				
		14 A37-M14	19,2	35,5	18,0	16,0	86,0	15,0	30/15				
		16 A37-M16	19,2	35,5	19,0	17,0	88,0	17,0	30/15				
		20 A37-M20	19,2	35,5	22,0	20,0	94,0	21,0	30/15				
240	185 240	8 A48-M8	21,1	39,0	13,0	11,0	77,5	8,4	20/10				
		10 A48-M10	21,1	39,0	13,0	11,0	77,5	10,5	20/10				
		12 A48-M12	21,1	39,0	14,0	12,0	79,5	13,2	20/10				
		14 A48-M14	21,1	39,0	18,0	16,0	92,0	15,0	20/10				
		16 A48-M16	21,1	39,0	19,0	17,0	94,0	17,0	20/10				
		20 A48-M20	21,1	39,0	22,0	20,0	100,0	21,0	20/10				
300	240 300	10 A60-M10	23,7	44,0	20,0	11,0	96,0	10,5	20/10				
		12 A60-M12	23,7	44,0	20,0	14,0	99,0	13,2	20/10				
		14 A60-M14	23,7	44,0	22,0	16,0	103,0	15,0	20/10				
		16 A60-M16	23,7	44,0	22,0	19,0	106,0	17,0	20/10				
		20 A60-M20	23,7	44,0	24,0	23,0	112,0	21,0	20/10				
		12 A80-M12	27,0	51,0	22,0	19,0	113,0	13,2	15/5				
400	300 400	14 A80-M14	27,0	51,0	22,0	19,0	113,0	15,0	15/5				
		16 A80-M16	27,0	51,0	22,0	19,0	113,0	17,0	15/5				
		20 A80-M20	27,0	51,0	24,0	23,0	119,0	21,0	15/5				
		16 A100-M16	30,3	56,5	22,0	19,0	117,0	17,0	10/1				
500	400 500	20 A100-M20	30,3	56,5	24,0	23,0	123,0	21,0	10/1				
		16 A120-M16*	33,4	61,6	22,0	19,0	128,0	17,0	9/1				
630	500 630	20 A120-M20*	33,4	61,6	24,0	23,0	134,0	21,0	9/1				
		16 A160-M16*	38,0	72,0	24,0	19,0	141,0	17,0	5/1				
800	630	20 A160-M20*	38,0	72,0	24,0	23,0	145,0	21,0	6/1				
		16 A200-M16*	44,0	80,0	24,0	19,0	158,0	17,0	5/1				
1000	800	20 A200-M20*	44,0	80,0	24,0	23,0	162,0	21,0	5/1				

*Actual conductor section may require a larger lug eg for 120mm² size use A30-... lug.

**See page 139

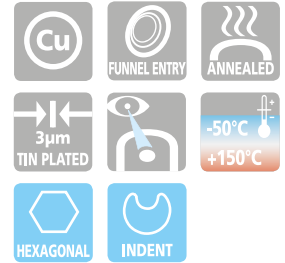

*Not UL approved

for L.V. circuit breakers - for Copper conductors

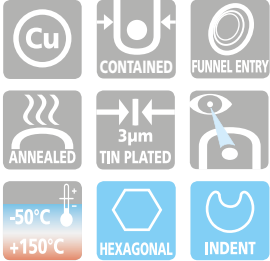
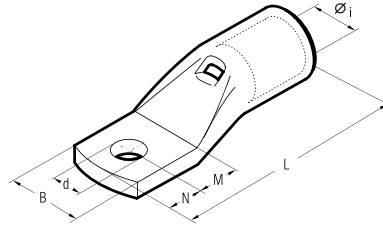

Cond. Size Flexible sqmm	Ø Stud mm	Type	Dimensions mm						Quantity Box/Bag	Mechanical Tools	Hydraulic Tools				
			Øi	B	M	N	L	d			HT45-E	HT51	RH50	ECW-H3D	
10	5	A2-M5/9	4,6	9,0	6,5	6,0	26,0	5,3	1.000/100	HN5 HN-A25 TN70SE	B15MD	HT45-E	HT51	RH50	ECW-H3D
16	5	A3-M5/9	5,8	9,0	6,5	6,0	30,5	5,3	1.000/100						
25	5	A5-M5/9	7,0	9,0	6,5	6,0	31,5	5,3	500/100						
35	6	A7B-M6/11.5*	8,9	11,5	8,0	7,0	36,5	6,4	400/100	TN120SE					
50	6	A10B-M6/11.5*	10,0	11,5	8,0	7,0	40,5	6,4	200/50						
70	6	A14B-M6/11.5*	11,3	11,5	8,0	7,0	44,5	6,4	200/50						
95	8	A19B-M8/15.5*	13,5	15,5	9,0	8,0	52,5	8,4	100/25						
120	8	A24B-M8/19*	15,2	19,0	14,0	9,0	60,0	8,4	75/25						
	10	A24B-M10/19*	15,2	19,0	14,0	9,0	60,0	10,5	75/25						
150	8	A30B-M8/19*	16,7	19,0	18,0	9,0	70,0	8,4	50/25						
	10	A30B-M10/19*	16,7	19,0	18,0	9,0	70,0	10,5	50/25						
185	10	A37B-M10/24.5*	19,2	24,5	18,0	9,0	77,0	10,5	30/15						
	10	A48-M10/31	21,1	31,0	13,0	9,0	80,0	10,5	20/10						
240	12	A48-M12/31	21,1	31,0	16,0	12,0	86,0	13,2	20/10						
	16	A48-M16/31	21,1	31,0	19,0	17,0	94,0	17,0	20/10						
	10	A60B-M10/31*	23,7	31,0	16,0	12,0	95,0	10,5	20/10						
300	12	A60B-M12/31*	23,7	31,0	16,0	12,0	95,0	13,2	20/10						
	12	A60B-M12/31*	23,7	31,0	16,0	12,0	95,0	13,2	20/10						

*Without inspection hole

This range of terminals features contained palm width and has been specifically developed for application on L.V. circuit breakers with reduced space terminal blocks.

The contained palm width allows an immediate and easier installation.

Cembre terminals are manufactured from electrolytic Copper tube with a purity greater than 99.9%.

The specifically designed section of the barrel and the choice of principal dimensions are optimising the best combination of mechanical strength and electrical conductivity.

These terminals are annealed to guarantee optimum ductility and are electrolytically Tin plated to avoid oxidation.

The barrel is provided with an internal taper to ease the introduction of the conductor; furthermore, its length grants a comfortable and correct positioning between dies, during crimping operations.

Each palm is marked with the Cembre logo and part number.

Details of the appropriate crimping tools and dies are shown on pages 260 to 261.



COPPER TUBE CRIMPING LUGS

for extra flexible Copper conductors

A-M

for fine stranded
flexible conductors
SPECIAL

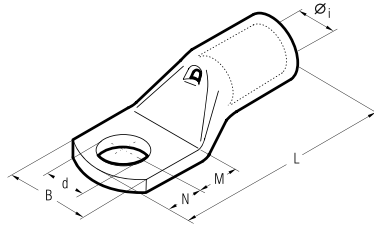

Conductor Size Extra Flexible sqmm	Ø Stud mm	Type	Dimensions mm						Quantity Box/Bag	Mechanical Tools	Hydraulic Tools						
			Øi	B	M	N	L	d									
35	6	A9-M6/15	9,3	15,0	8,0	7,0	38,5	6,4	400/100	TN70SE	HT45-E B450ND-BV						
	8	A9-M8	9,3	17,0	9,0	8,0	40,5	8,4	400/100								
	10	A9-M10	9,3	18,5	11,0	10,0	44,5	10,5	300/100								
	12	A9-M12	9,3	21,0	14,0	12,0	49,5	13,2	300/50								
50	6	A12-M6/15	11,0	15,0	8,0	7,0	40,5	6,4	200/50								
	8	A12-M8	11,0	19,3	9,0	8,0	42,5	8,4	200/50								
	10	A12-M10	11,0	19,3	11,0	10,0	46,5	10,5	200/50								
	10	A12-M10/19	11,0	19,0	11,0	10,0	46,5	10,5	200/50								
	12	A12-M12	11,0	22,0	14,0	12,0	51,5	13,2	200/50								
70	6	A17-M6	13,0	23,0	8,0	7,0	45,0	6,4	200/50			TN120SE	HT45-E B450ND-BV				
	8	A17-M8	13,0	23,0	9,0	8,0	47,0	8,4	150/50								
	10	A17-M10	13,0	23,0	11,0	10,0	51,0	10,5	150/50								
	10	A17-M10/19	13,0	19,0	11,0	10,0	51,0	10,5	200/50								
	12	A17-M12	13,0	23,0	14,0	12,0	56,0	13,2	150/50								
	14	A17-M14	13,0	25,0	15,5	12,0	57,5	15,0	150/25								
95	16	A17-M16	13,0	27,0	16,5	13,5	60,0	17,0	100/25					HT51 RH50 B500ND HT81-U RHU81	HT120 and tools and heads with 130 kN crimping force ECW-H3D RHU520		
	8	A20-M8	15,0	27,0	9,0	8,0	50,0	8,4	100/25								
	10	A20-M10	15,0	27,0	11,0	10,0	54,0	10,5	100/25								
	12	A20-M12	15,0	27,0	14,0	12,0	59,0	13,2	100/25								
	14	A20-M14	15,0	27,0	15,5	12,0	60,5	15,0	100/25								
120	16	A20-M16	15,0	27,0	16,5	13,5	63,0	17,0	100/25	HT51 RH50 B500ND HT81-U RHU81	HT120 and tools and heads with 130 kN crimping force ECW-H3D RHU520						
	8	A29-M8	16,5	30,0	9,0	8,0	53,5	8,4	100/25								
	10	A29-M10	16,5	30,0	11,0	10,0	57,5	10,5	50/25								
	12	A29-M12	16,5	30,0	14,0	12,0	62,5	13,2	50/25								
	14	A29-M14	16,5	30,0	15,5	12,0	64,0	15,0	100/25								
	16	A29-M16	16,5	30,0	16,5	13,5	66,5	17,0	100/25								
150	20	A29-M20	16,5	30,0	22,0	20,0	78,5	21,0	75/25							HT51 RH50 B500ND HT81-U RHU81	HT120 and tools and heads with 130 kN crimping force ECW-H3D RHU520
	10	A35-M10	19,2	34,2	13,0	11,0	65,5	10,5	50/25								
	12	A35-M12	19,2	34,2	16,0	14,0	71,5	13,2	50/25								
	14	A35-M14	19,2	34,2	18,0	16,0	75,5	15,0	50/25								
	16	A35-M16	19,2	34,2	19,0	17,0	77,5	17,0	30/15								
185	20	A35-M20	19,2	34,2	22,0	20,0	83,5	21,0	30/15			HT51 RH50 B500ND HT81-U RHU81	HT120 and tools and heads with 130 kN crimping force ECW-H3D RHU520				
	10	A40-M10	21,0	37,5	13,0	11,0	73,0	10,5	30/15								
	12	A40-M12	21,0	37,5	16,0	14,0	79,0	13,2	30/15								
	14	A40-M14	21,0	37,5	18,0	16,0	83,0	15,0	30/15								
185	16	A40-M16	21,0	37,5	19,0	17,0	85,0	17,0	30/15					HT51 RH50 B500ND HT81-U RHU81	HT120 and tools and heads with 130 kN crimping force ECW-H3D RHU520		
	20	A40-M20	21,0	37,5	22,0	20,0	91,0	21,0	30/15								

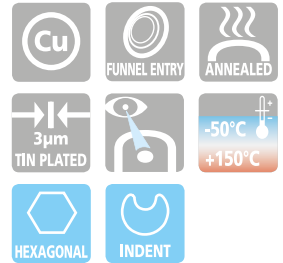

These lugs are particularly recommended for use with extra flexible conductors on for instance, welding machines.

A-M series lugs are designed to suit panel applications.

The dimensions of the tube are designed to obtain the most efficient electrical conductivity and mechanical strength to resist vibration and pull out.

Cembre lugs are annealed to guarantee optimum ductility and electrolytically Tin plated to avoid oxidation.

The presence of an inspection hole facilitates full insertion of the conductor.

Details of the appropriate crimping tools and dies are shown on pages 260 to 261.

A-L

COPPER TUBE CRIMPING LUGS ANGLED 90°

for Copper conductors

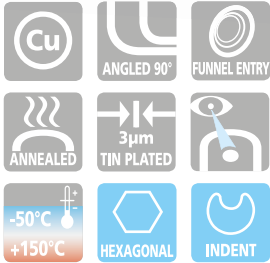
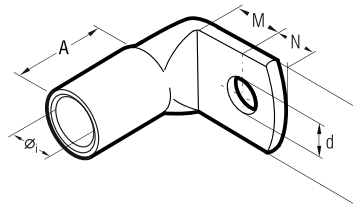

A-L series lugs angled 90° are manufactured from electrolytic Copper tube with a purity greater than 99.9%.

The dimensions of the tube are designed to obtain the most efficient electrical conductivity and mechanical strength to resist vibration and pull out.

Cembre lugs are annealed to guarantee optimum ductility which is an absolute necessity for connectors which will have to withstand the severe deformation arising when compressed and any bending of the palm during installation.

In applications subject to vibration, terminals still have to perform a reliable connection, annealing plays a vital role in avoiding cracking or breaks between the barrel and palm.

The presence of an inspection hole facilitates full insertion of the conductor, whilst the barrel length has been designed to allow easy and accurate positioning of the dies during the crimping operation. Lugs are electrolytically Tin plated to avoid oxidation.

Details of the appropriate crimping tools and dies are shown on pages 260 to 261.

Conductor Size sqmm	Ø Stud mm	Type	Dimensions mm						Quantity Box/Bag	Mechanical Tools		Hydraulic Tools		
			Low Str.	Flex*	Øi	B	M	N		A	d			
6	6	A1-L6*	3,6	11,0	7,0	6,0	8,0	6,4	2.000/100	HNI	HNS	HN-A25	B15MD	
		A2-L4	4,6	10,0	5,0	4,0	8,0	4,3	1.500/100					
10	10	A2-L5	4,6	10,0	6,5	6,0	8,0	5,3	1.000/100	HNI	HNS	HN-A25	B15MD	
		A2-L6	4,6	11,0	7,0	6,0	8,0	6,4	1.000/100					
16	16	A2-L8	4,6	15,0	9,0	8,0	8,0	8,4	500/100	HNI	HNS	HN-A25	B15MD	
		A3-L5	5,8	11,5	6,5	6,0	11,5	5,3	1.000/100					
25	25	A3-L6	5,8	11,5	7,0	6,0	11,5	6,4	1.000/100	HNI	HNS	HN-A25	B15MD	
		A3-L8	5,8	15,0	9,0	8,0	11,5	8,4	500/100					
35	35	A3-L10	5,8	18,0	11,0	10,0	11,5	10,5	500/100	HNI	HNS	HN-A25	B15MD	
		A5-L6	7,0	14,0	7,0	6,0	10,5	6,4	500/100					
50	50	A5-L8	7,0	15,0	9,0	8,0	10,5	8,4	500/100	HNI	HNS	HN-A25	B15MD	
		A5-L10	7,0	18,0	11,0	10,0	10,5	10,5	500/100					
70	70	A7-L6	8,9	17,0	7,0	6,0	13,2	6,4	300/100	HNI	HNS	HN-A25	B15MD	
		A7-L8	8,9	17,0	9,0	8,0	13,2	8,4	300/100					
95	95	A7-L10	8,9	19,0	11,0	10,0	13,2	10,5	300/100	HNI	HNS	HN-A25	B15MD	
		A7-L12	8,9	21,0	14,0	12,0	13,2	13,2	300/100					
120	120	A10-L6	10,0	19,0	8,0	7,0	16,5	6,4	300/100	HNI	HNS	HN-A25	B15MD	
		A10-L8	10,0	19,0	9,0	8,0	16,5	8,4	200/100					
150	150	A10-L10	10,0	20,0	11,5	9,5	16,5	10,5	200/50	HNI	HNS	HN-A25	B15MD	
		A10-L12	10,0	21,0	12,0	12,0	16,5	13,2	200/50					
185	185	A14-L8	11,3	21,0	9,0	8,0	18,0	8,4	200/50	HNI	HNS	HN-A25	B15MD	
		A14-L10	11,3	21,0	11,0	10,0	18,0	10,5	100/50					
240	240	A14-L12	11,3	22,0	14,0	12,0	18,0	13,2	100/50	HNI	HNS	HN-A25	B15MD	
		A14-L16	11,3	26,0	18,0	16,0	18,0	17,0	150/50					
300	300	A19-L8	13,5	25,0	9,0	8,0	22,5	8,4	100/25	HNI	HNS	HN-A25	B15MD	
		A19-L10	13,5	25,0	11,0	10,0	22,5	10,5	100/25					
300	300	A19-L12	13,5	25,0	14,0	12,0	22,5	13,2	100/25	HNI	HNS	HN-A25	B15MD	
		A24-L10	15,2	28,5	11,0	10,0	24,0	10,5	50/25					
300	300	A24-L12	15,2	28,5	14,0	12,0	24,0	13,2	50/25	HNI	HNS	HN-A25	B15MD	
		A30-L10	16,7	31,5	13,0	11,0	26,5	10,5	50/25					
300	300	A30-L12	16,7	31,5	16,0	14,0	26,5	13,2	50/25	HNI	HNS	HN-A25	B15MD	
		A37-L10	19,2	35,5	13,0	11,0	29,0	10,5	30/15					
300	300	A37-L12	19,2	35,5	16,0	14,0	29,0	13,2	50/25	HNI	HNS	HN-A25	B15MD	
		A48-L10	21,1	39,0	13,0	11,0	33,0	10,5	30/15					
300	300	A48-L12	21,1	39,0	16,0	14,0	33,0	13,2	20/10	HNI	HNS	HN-A25	B15MD	
		A60-L12	23,7	44,0	20,0	14,0	40,0	13,2	20/10					

*Actual conductor section may require a larger lug eg for 120mm² size use A30-... lug.

**See page 139

*Not UL approved

COPPER TUBE CRIMPING LUGS

double hole fixing - for Copper conductors

A-2M

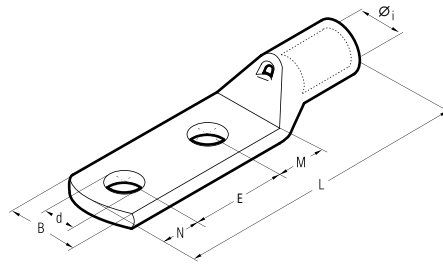

Conductor Size sqmm	Ø Stud mm	Type	Dimensions mm								Quantity Box/Bag	Mechanical Tools	Hydraulic Tools
			Øi	B	M	N	E	L	d				
10	4	A2-2M4-12	4,6	10,0	5,0	4,0	12,0	36,5	4,3	100	HN1 HNS HN-A25	BT15MD	
	8	A2-2M8-20	4,6	15,0	11,0	11,0	20,0	57,5	8,4	100			
16	8	A3-2M8-20	5,8	15,0	11,0	11,0	20,0	62,0	8,4	50	HN-A25	BT15MD	
	12	A3-2M12-40	5,8	20,0	14,0	12,0	40,0	82,5	13,2	200/50			
25	8	A5-2M8-20	7,0	15,0	9,0	11,0	20,0	59,0	8,4	400/100	TN70SE	BT15MD	
	8	A5-2M8-24-24	7,0	15,0	24,0	11,0	24,0	78,0	8,4	300/100			
25	10	A5-2M10-24-13	7,0	18,0	13,0	11,0	24,0	67,0	10,5	300/100	TN70SE	BT15MD	
	10	A7-2M10	8,9	19,0	11,0	10,0	44,5	87,0	10,5	100/50			
35	10	A7-2M10-25	8,9	19,0	12,0	11,0	25,0	69,5	10,5	100	TN70SE	BT15MD	
	12	A7-2M12	8,9	21,0	16,0	14,0	44,5	96,0	13,2	200/100			
35	12	A7-2M12-25	8,9	21,0	16,0	14,0	25,0	76,5	13,2	50	TN70SE	BT15MD	
	12	A7-2M12-40	8,9	21,0	16,0	14,0	40,0	91,5	13,2	150/50			
50	6	A10-2M6	10,0	19,0	8,0	11,0	44,5	89,0	6,4	50	TN120SE	BT15MD	
	8	A10-2M8	10,0	19,0	11,0	11,0	44,5	92,0	8,4	100/50			
50	8	A10-2M8-20	10,0	19,0	11,0	11,0	20,0	67,5	8,4	100/50	TN120SE	BT15MD	
	8	A10-2M8-22	10,0	19,0	11,0	11,0	22,0	69,5	8,4	150/50			
50	8	A10-2M8-30	10,0	19,0	11,0	11,0	30,0	77,5	8,4	150/50	TN120SE	BT15MD	
	8	A10-2M8-24-24	10,0	19,0	24,0	11,0	24,0	84,5	8,4	150/50			
50	10	A10-2M10	10,0	20,0	13,0	11,0	44,5	94,0	10,5	100/50	TN120SE	BT15MD	
	10	A10-2M10-24-13	10,0	19,0	13,0	11,0	24,0	73,5	10,5	150/50			
50	12	A10-2M12	10,0	21,0	16,0	14,0	44,5	100	13,2	100/50	TN120SE	BT15MD	
	12	A10-2M12-25	10,0	21,0	16,0	14,0	25,0	80,5	13,2	50			
70	8	A14-2M8	11,3	21,0	11,0	11,0	44,5	95,5	8,4	50	TN120SE	BT15MD	
	8	A14-2M8-24-24	11,3	21,0	24,0	11,0	24,0	88,0	8,4	100/50			
70	10	A14-2M10	11,3	21,0	13,0	11,0	44,5	97,5	10,5	100/50	TN120SE	BT15MD	
	10	A14-2M10-24	11,3	21,0	13,0	11,0	24,0	77,0	10,5	100/50			
70	12	A14-2M12	11,3	22,0	16,0	14,0	44,5	103,5	13,2	100/50	TN120SE	BT15MD	
	12	A14-2M12-25	11,3	22,0	16,0	14,0	25,0	84,0	13,2	50			
70	12	A14-2M12-30-29	11,3	22,0	29,0	14,0	30,0	102,0	13,2	100/50	TN120SE	BT15MD	
	12	A14-2M12-40	11,3	22,0	16,0	14,0	40,0	99,0	13,2	100/50			
70	14	A14-2M14	11,3	25,0	18,0	16,0	44,5	107,5	15,0	100/50	TN120SE	BT15MD	
	6	A19-2M6	13,5	25,0	10,0	11,0	44,5	101,0	6,4	25			
95	8	A19-2M8-50 S	13,5	25,0	15,0	15,0	50,0	115,5	8,4	75/25	TN120SE	BT15MD	
	10	A19-2M10	13,5	25,0	13,0	11,0	44,5	104,0	10,5	50/25			
95	10	A19-2M10-24-13	13,5	25,0	13,0	11,0	24,0	83,5	10,5	75/25	TN120SE	BT15MD	
	10	A19-2M10-24-26	13,5	25,0	26,0	11,0	24,0	96,5	10,5	50/25			
95	10	A19-2M10-40	13,5	25,0	13,0	11,0	40,0	99,5	10,5	75/25	TN120SE	BT15MD	
	12	A19-2M12	13,5	25,0	16,0	14,0	44,5	110,0	13,2	75/25			
95	12	A19-2M12-25	13,5	25,0	16,0	14,0	25,0	90,5	13,2	25	TN120SE	BT15MD	
	12	A19-2M12-30-29	13,5	25,0	29,0	14,0	30,0	108,5	13,2	50/25			
95	14	A19-2M14	13,5	25,0	18,0	16,0	44,5	114,0	15,0	100/25	TN120SE	BT15MD	
	14	A19-2M14-25	13,5	25,0	18,0	16,0	25,0	94,5	15,0	25			
120	16	A19-2M16	13,5	25,0	19,0	17,0	44,5	116,0	17,0	50/25	TN120SE	BT15MD	
	8	A24-2M8-20	15,2	28,5	11,0	11,0	20,0	79,0	8,4	25			
120	8	A24-2M8-24-29	15,2	28,5	29,0	11,0	24,0	101,0	8,4	50/25	TN120SE	BT15MD	
	10	A24-2M10	15,2	28,5	13,0	11,0	44,5	105,5	10,5	50/25			
120	10	A24-2M10-22	15,2	28,5	13,0	11,0	22,0	83,0	10,5	25	TN120SE	BT15MD	
	10	A24-2M10-25/24	15,2	24,0	13,0	11,0	25,0	86,0	10,5	50/25			
120	10	A24-2M10-33.5	15,2	28,5	13,0	11,0	33,5	94,5	10,5	50/25	TN120SE	BT15MD	
	10	A24L-2M10-30AS	15,2	28,5	13,0	11,0	30,0	91,0	10,5	25			
120	12	A24-2M12	15,2	28,5	16,0	14,0	44,5	113,0	13,2	50/25	TN120SE	BT15MD	
	12	A24-2M12-30-29	15,2	28,5	29,0	14,0	30,0	110,0	13,2	50/25			
120	12	A24-2M12-40	15,2	28,5	16,0	14,0	40,0	107,0	13,2	50/25	TN120SE	BT15MD	
	14	A24-2M14	15,2	28,5	18,0	16,0	44,5	115,5	15,0	50/25			
120	16	A24-2M16	15,2	28,5	19,0	17,0	44,5	117,5	17,0	50/25	TN120SE	BT15MD	

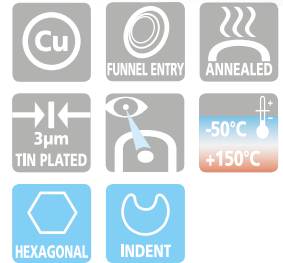

A-2M series lugs are manufactured from electrolytic copper tube with a purity greater than 99.9%.

The dimensions of the tube are designed to obtain the most efficient electrical conductivity and mechanical strength to resist vibration and pull out.

The double hole fixing ensures greater mechanical stability even in the presence of electrodynamic stresses.

Cembre lugs are annealed to guarantee optimum ductility, an absolute necessity for connectors which will have to withstand the severe deformation arising when compressed and any bending of the palm during installation.

In applications subject to vibration, terminals still have to perform a reliable connection, annealing plays a vital role in avoiding cracking or breaks between the barrel and palm.

The presence of an inspection hole facilitates full insertion of the conductor, whilst the barrel length has been designed to allow easy and accurate positioning of the dies during the crimping operation. Lugs are electrolytically tinplated to avoid oxidation.

A-2M series lugs form an important part of Cembre crimping systems for power carrying conductors, details of the appropriate crimping tools and dies are shown opposite and in detail on page 260-261, whilst our technicians are always available to provide any technical advice which may be required.

The enclosed table is only indicative of the range and many variations in stud fixing and palm lengths are also available.

double hole fixing - for Copper conductors

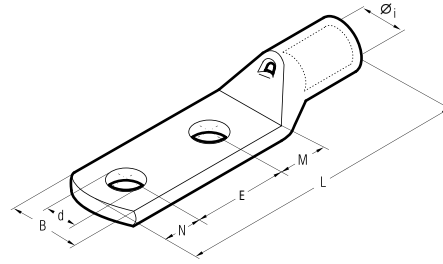

Conductor Size sqmm	Ø Stud mm	Type	Dimensions mm							Quantity Box/Bag	Mechanical Tools	Hydraulic Tools	
			Øi	B	M	N	E	L	d				
150	8	A30-2M8-20	16,7	31,5	13,0	11,0	20,0	89,0	8,4	50/25	TN1205E*	HT51	RH50 B500
	10	A30-2M10	16,7	31,5	13,0	11,0	44,5	113,5	10,5	50/25			
	10	A30-2M10-24-28	16,7	31,5	28,0	11,0	24,0	108,0	10,5	50/25			
	12	A30-2M12	16,7	31,5	16,0	14,0	44,5	119,5	13,2	50/25			
	12	A30-2M12-30	16,7	31,5	16,0	14,0	30,0	105,0	13,2	50/25			
	12	A30-2M12-30-29	16,7	31,5	29,0	14,0	30,0	118,0	13,2	30/15			
	12	A30-2M12-40	16,7	31,5	16,0	14,0	40,0	115,0	13,2	30/15			
	14	A30-2M14	16,7	31,5	18,0	16,0	44,5	123,5	15,0	50/25			
185	14	A30-2M14-33.5	16,7	31,5	18,0	16,0	33,5	112,5	15,0	50/25	HT51	RH50 B500	
	10	A37-2M10	19,2	35,5	13,0	11,0	44,5	120,5	10,5	30/15			
	10	A37-2M10-25	19,2	35,5	13,0	11,0	25,0	101,0	10,5	30/15			
	12	A37-2M12	19,2	35,5	16,0	14,0	44,5	126,5	13,2	30/15			
	12	A37-2M12-32	19,2	35,5	16,0	14,0	32,0	114,0	13,2	30/15			
	12	A37-2M12-30-31	19,2	35,5	31,0	14,0	30,0	127,0	13,2	30/15			
	14	A37-2M14	19,2	35,5	18,0	16,0	44,5	130,5	15,0	30/15			
	14	A37-2M14-35	19,2	35,5	18,0	16,0	35,0	121,0	15,0	15			
240	16	A37-2M16	19,2	35,5	19,0	17,0	44,5	132,5	17,0	30/15	HT51	RH50 B500	
	16	A37-2M16-40	19,2	35,5	19,0	17,0	40,0	128,0	17,0	15			
	10	A48-2M10	21,1	39,0	13,0	11,0	44,5	126,5	10,5	30/15			
	10	A48-2M10-20	21,1	39,0	13,0	11,0	20,0	102,0	10,5	15			
	10	A48-2M10-35	21,1	39,0	13,0	11,0	35,0	117,0	10,5	15			
	12	A48-2M12	21,1	39,0	16,0	14,0	44,5	132,5	13,2	30/15			
	12	A48-2M12-35	21,1	39,0	16,0	14,0	35,0	123,0	13,2	30/15			
	12	A48-2M12-40	21,1	39,0	16,0	14,0	40,0	128,0	13,2	30/15			
300	12	A48-2M12-30-31	21,1	39,0	31,0	14,0	30,0	133,0	13,2	20/10	HT51	RH50 B500	
	14	A48-2M14	21,1	39,0	18,0	16,0	44,5	136,5	15,0	30/15			
	14	A48-2M14-40	21,1	39,0	18,0	16,0	40,0	132,0	15,0	30/15			
	16	A48-2M16	21,1	39,0	19,0	17,0	44,5	138,5	17,0	30/15			
	10	A60-2M10	23,7	44,0	13,0	11,0	44,5	133,5	10,5	20/5			
	12	A60-2M12	23,7	44,0	20,0	14,0	44,5	143,5	13,2	20/5			
	12	A60-2M12-40	23,7	44,0	20,0	14,0	40,0	139,0	13,2	20/5			
	12	A60-2M12-30-38	23,7	44,0	38,0	14,0	30,0	147,0	13,2	20/5			
400	14	A60-2M14	23,7	44,0	22,0	16,0	44,5	147,5	15,0	20/5	HT51	RH50 B500	
	16	A60-2M16-40	23,7	44,0	22,0	17,0	40,0	144,0	17,0	20/5			
	16	A60-2M16	23,7	44,0	22,0	17,0	44,5	148,5	17,0	20/5			
	16	A60-2M16-35	23,7	44,0	22,0	17,0	35,0	139,0	17,0	20/5			
	16	A60-2M16/36	23,7	36,0	22,0	17,0	44,5	148,5	17,0	20/5			
	12	A80-2M12	27,0	51,0	22,0	14,0	44,5	152,5	13,2	15/5			
	14	A80-2M14	27,0	51,0	22,0	16,0	44,5	154,5	15,0	15/5			
	14	A80-2M14-40	27,0	51,0	22,0	16,0	40,0	150,0	15,0	15/5			
500	16	A80-2M16	27,0	51,0	22,0	19,0	44,5	157,5	17,0	15/5	HT51	RH50 B500	
	16	A80-2M16-40	27,0	51,0	22,0	19,0	40,0	153,0	17,0	15/5			
	16	A80-2M16/41	27,0	41,0	22,0	19,0	44,5	157,5	17,0	15/5			
	16	A80-2M16-50	27,0	51,0	22,0	19,0	50,0	163,0	17,0	5			
630	12	A100-2M12	30,3	56,5	20,0	14,0	44,5	152,0	13,2	10/1	HT51	RH50 B500	
	14	A100-2M14-40	30,3	56,5	17,0	16,0	40,0	149,0	15,0	1			
	14	A100-2M14	30,3	56,5	17,0	16,0	44,5	153,5	15,0	10/1			
800	16	A100-2M16	30,3	56,5	19,0	19,0	44,5	158,5	17,0	10/5	HT51	RH50 B500	
	12	A120-2M12*	33,4	61,6	22,0	14,0	44,5	167,5	13,2	20/5			
	16	A120-2M16*	33,4	61,6	22,0	19,0	44,5	172,5	17,0	8/1			
800	12	A160-2M12*	38,0	72,0	20,0	14,0	44,5	176,5	13,2	9/3	HT51	RH50 B500	
	16	A160-2M16*	38,0	72,0	22,0	19,0	44,5	183,5	17,0	9/3			

*See page 139

*Not UL approved

COPPER TUBE CRIMPING LUGS ANGLED 315° and 345°

A-2M

double hole fixing - for Copper conductors

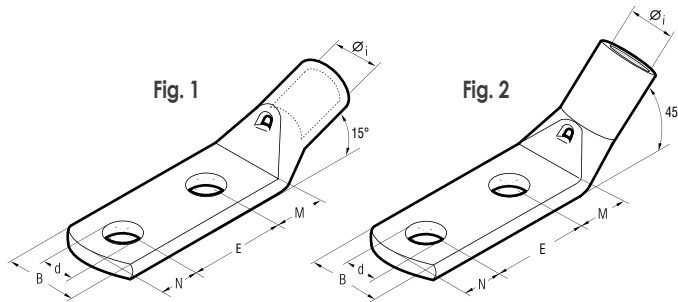

Conductor Size sqmm	Ø Stud mm	Type	Fig. N.	Dimensions mm							Quantity Box/Bag	Mechanical Tools	Hydraulic Tools
				Øi	B	M	N	E	d				
25	8	A5-2M8-24-24/345	1	7,0	15,0	24,0	11,0	24,0	8,4	300/100	HN-A25	HT45-E B450ND-BV	
	12	A5-2M12-3029/345	1	7,0	21,0	29,0	14,0	30,0	13,2	200/100			
50	8	A10-2M8-2424/345	1	10,0	19,0	24,0	11,0	24,0	8,4	150/50	TN70SE	HT51	
	8	A14-2M8-2424/345	1	11,3	21,0	24,0	11,0	24,0	8,4	100/50			
70	10	A14-2M102426/315	2	11,3	21,0	26,0	11,0	24,0	10,5	100/50	TN120SE*	HT81-U RHU81	
	10	A14-2M102426/345	1	11,3	21,0	26,0	11,0	24,0	10,5	100/50			
	12	A14-2M123029/345	1	11,3	22,0	29,0	14,0	30,0	13,2	100/50			
95	8	A19-2M8-2424/345	1	13,5	25,0	24,0	11,0	24,0	8,4	75/25	HT120 and tools and heads with 130 kN crimping force	RHU520	
	10	A19-2M102426/345	1	13,5	25,0	26,0	11,0	24,0	10,5	25			
	12	A19-2M123029/345	1	13,5	25,0	29,0	14,0	30,0	13,2	75/25			
120	8	A24-2M8-2429/345	1	15,2	28,5	29,0	11,0	24,0	8,4	50/25	ECW-H3D	RHU520	
	10	A24-2M102429/345	1	15,2	28,5	29,0	11,0	24,0	10,5	50/25			
	12	A24-2M123029/345	1	15,2	28,5	29,0	14,0	30,0	13,2	50/25			
150	8	A30-2M8-2429/345	1	16,7	31,5	29,0	11,0	24,0	8,4	30/15	ECW-H3D	RHU520	
	10	A30-2M102428/345	1	16,7	31,5	28,0	11,0	24,0	10,5	50/25			
	12	A30-2M123029/345	1	16,7	31,5	29,0	14,0	30,0	13,2	40/20			
185	10	A37-2M10-25/315	2	19,2	35,5	13,0	11,0	25,0	10,5	15	ECW-H3D	RHU520	
	12	A37-2M123031/345	1	19,2	35,5	31,0	14,0	30,0	13,2	30/15			
240	12	A48-2M12/345	1	21,1	39,0	16,0	14,0	44,5	13,2	20/10	ECW-H3D	RHU520	
	12	A48-2M12-30/45	1	21,1	39,0	16,0	14,0	44,5	13,2	20/10			
	12	A48-2M123031/345	1	21,1	39,0	31,0	14,0	30,0	13,2	20/10			
300	12	A60-2M123038/345	1	23,7	44,0	38,0	14,0	30,0	13,2	20/10	ECW-H3D	RHU520	

*See page 139

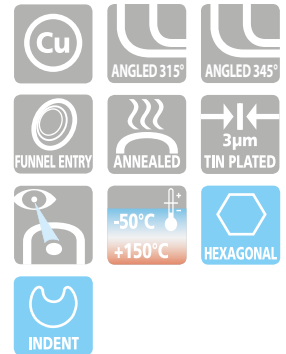

A-2M series lugs angled 315° and 345° are manufactured from electrolytic copper tube with a purity greater than 99.9%.

The dimensions of the tube are designed to obtain the most efficient electrical conductivity and mechanical strength to resist vibration and pull out.

The double hole fixing ensures greater mechanical stability even in the presence of electrodynamic stresses.

Cembre lugs are annealed to guarantee optimum ductility, an absolute necessity for connectors which will have to withstand the severe deformation arising when compressed and any bending of the palm during installation.

In applications subject to vibration, terminals still have to perform a reliable connection, annealing plays a vital role in avoiding cracking or breaks between the barrel and palm.

The presence of an inspection hole facilitates full insertion of the conductor, whilst the barrel length has been designed to allow easy and accurate positioning of the dies during the crimping operation. Lugs are electrolytically tinplated to avoid oxidation.

Details of the appropriate crimping tools and dies are shown on pages 260 to 261.

2A-M

HEAVY DUTY COPPER TUBE TERMINALS

for Copper conductors

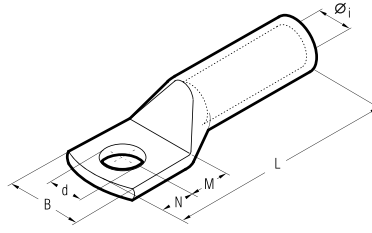

The 2A-M series cable lugs are designed for heavy duty, for grounding structures and equipment both indoors and outdoors and for medium voltage applications up to 35 kV.

2A-M series terminals are made from high purity Copper tube with a purity greater than 99.9%, and are annealed.

They feature a double length barrel for enhanced electrical and mechanical performance in heavy duty applications.

The absence of an inspection hole prevents the entry of water or moisture into the crimped joint making these terminals suitable for outdoor applications.

The terminals are electrolytically Tin plated to prevent atmospheric corrosion.

Details of the appropriate crimping tools and dies are shown on pages 260 to 261.

Conductor Size sqmm	Ø Stud mm	Type	Dimensions mm						Quantity Box/Bag	Mechanical Tools	Hydraulic Tools	
			Øi	B	M	N	L	d				
16	8	2A3-M8	5,8	15,0	9,0	8,0	43,5	8,4	600/100	HN5	B15MD	
	10	2A3-M10	5,8	18,0	11,0	10,0	47,5	10,5	500/100			
25	8	2A5-M8	7,0	15,0	9,0	8,0	51,0	8,4	400/100	HN-A25		
	10	2A5-M10	7,0	18,0	11,0	10,0	55,0	10,5	300/50			
25	12	2A5-M12	7,0	21,0	14,0	12,0	60,0	13,2	300/50	TN70SE		
	8	2A7-M8	8,9	17,0	9,0	8,0	53,0	8,4	200/50			
35	10	2A7-M10	8,9	19,0	11,0	10,0	57,0	10,5	200/50	TN70SE		
	12	2A7-M12	8,9	21,0	14,0	12,0	62,0	13,2	200/50			
50	10	2A10-M10	10,0	20,0	11,0	10,0	63,0	10,5	100/50	TN70SE		
	12	2A10-M12	10,0	21,0	14,0	12,0	68,0	13,2	100/50			
50	14	2A10-M14	10,0	25,0	16,0	14,0	72,0	15,0	150/50	TN70SE		
	16	2A10-M16	10,0	26,0	18,0	16,0	76,0	17,0	150/50			
63	10	2A14-M10	11,3	21,0	11,0	10,0	70,0	10,5	100/50	TN120 SE*	HT45-E B450ND-BV	
	12	2A14-M12	11,3	22,0	14,0	12,0	75,0	13,2	100/50			
70	14	2A14-M14	11,3	25,0	16,0	14,0	79,0	15,0	100/50	TN120 SE*	HT45-E B450ND-BV	
	16	2A14-M16	11,3	26,0	18,0	16,0	83,0	17,0	100/50			
95	10	2A19-M10	13,5	25,0	11,0	10,0	76,5	10,5	50/25	TN120 SE*	HT45-E B450ND-BV	
	12	2A19-M12	13,5	25,0	14,0	12,0	81,5	13,2	50/25			
95	14	2A19-M14	13,5	25,0	16,0	14,0	85,5	15,0	75/25	TN120 SE*	HT45-E B450ND-BV	
	16	2A19-M16	13,5	27,0	18,0	16,0	90,5	17,0	50/25			
95	20	2A19-M20	13,5	29,5	22,0	20,0	97,5	21,0	75/25	TN120 SE*	HT45-E B450ND-BV	
	10	2A24-M10	15,2	28,5	11,0	10,0	82,0	10,5	30/15			
120	12	2A24-M12	15,2	28,5	14,0	12,0	87,0	13,2	30/15	TN120 SE*	HT45-E B450ND-BV	
	14	2A24-M14	15,2	28,5	16,0	14,0	91,0	15,0	30/15			
125	16	2A24-M16	15,2	28,5	18,0	16,0	95,0	17,0	30/15	TN120 SE*	HT45-E B450ND-BV	
	20	2A24-M20	15,2	30,0	22,0	20,0	103,0	21,0	50/25			
150	10	2A30-M10	16,7	31,5	13,0	11,0	92,0	10,5	30/15	TN120 SE*	HT45-E B450ND-BV	
	12	2A30-M12	16,7	31,5	16,0	14,0	98,0	13,2	30/15			
150	14	2A30-M14	16,7	31,5	18,0	16,0	102,0	15,0	30/15	TN120 SE*	HT45-E B450ND-BV	
	16	2A30-M16	16,7	31,5	19,0	17,0	104,0	17,0	30/15			
150	20	2A30-M20	16,7	31,5	22,0	20,0	110,0	21,0	30/15	TN120 SE*	HT45-E B450ND-BV	
	12	2A37-M12	19,2	35,5	16,0	14,0	108,0	13,2	20/10			
185	14	2A37-M14	19,2	35,5	18,0	16,0	112,0	15,0	30/15	TN120 SE*	HT45-E B450ND-BV	
	16	2A37-M16	19,2	35,5	19,0	17,0	114,0	17,0	30/15			
185	20	2A37-M20	19,2	35,5	22,0	20,0	120,0	21,0	30/15	TN120 SE*	HT45-E B450ND-BV	
	12	2A48-M12	21,1	39,0	16,0	14,0	109,0	13,2	20/5			
240	14	2A48-M14	21,1	39,0	18,0	16,0	113,0	15,0	20/5	TN120 SE*	HT45-E B450ND-BV	
	16	2A48-M16	21,1	39,0	19,0	17,0	115,0	17,0	20/5			
240	20	2A48-M20	21,1	39,0	22,0	20,0	121,0	21,0	25/5	TN120 SE*	HT45-E B450ND-BV	
	12	2A60-M12	23,7	44,0	20,0	14,0	129,5	13,2	15/5			
300	14	2A60-M14	23,7	44,0	22,0	16,0	133,5	15,0	15/5	TN120 SE*	HT45-E B450ND-BV	
	16	2A60-M16	23,7	44,0	22,0	19,0	136,5	17,0	15/5			
300	20	2A60-M20	23,7	44,0	24,0	23,0	142,5	21,0	15/5	TN120 SE*	HT45-E B450ND-BV	
	12	2A80-M12	27,0	51,0	22,0	19,0	140,0	13,2	15/5			
400	14	2A80-M14	27,0	51,0	22,0	19,0	140,0	15,0	10/5	TN120 SE*	HT45-E B450ND-BV	
	16	2A80-M16	27,0	51,0	22,0	19,0	140,0	17,0	10/5			
400	20	2A80-M20	27,0	51,0	24,0	23,0	146,0	21,0	15/5	TN120 SE*	HT45-E B450ND-BV	
	16	2A100-M16*	30,3	56,5	22,0	19,0	141,0	17,0	10/1			
500	20	2A100-M20*	30,3	56,5	24,0	23,0	147,0	21,0	10/1	TN120 SE*	HT45-E B450ND-BV	
	16	2A120-M16*	33,4	61,5	22,0	19,0	159,0	17,0	20/1			
630	20	2A120-M20*	33,4	61,5	24,0	23,0	165,0	21,0	20/1	TN120 SE*	HT45-E B450ND-BV	
	800	20	2A160-M20*	38,0	72,0	24,0	23,0	187,0	21,0			
1000	20	2A200-M20*	44,0	80,0	24,0	23,0	202,0	21,0	6/1	TN120 SE*	HT45-E B450ND-BV	

*See page 137

*Not UL approved

HEAVY DUTY COPPER TUBE TERMINALS

2A-2M

double hole fixing - for Copper conductors

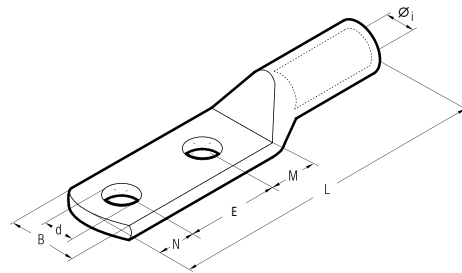

Conductor Size sqmm	Ø Stud mm	Type	Dimensions mm							Quantity Box/Bag	Mechanical Tools	Hydraulic Tools
			Øi	B	M	N	E	L	d			
50	12	2A10-2M12	10,0	21,0	14,0	12,0	44,5	112,5	13,2	75/25	TN70SE	HT45-E B450ND-BV
70	12	2A14-2M12	11,3	22,0	16,0	14,0	44,5	123,5	13,2	50/25		
	14	2A14-2M14	11,3	25,0	18,0	16,0	44,5	127,5	15,0	75/25	TN120 SE*	HT51
95	12	2A19-2M12	13,5	25,0	16,0	14,0	44,5	128,0	13,2	50/25		
	14	2A19-2M14	13,5	25,0	18,0	16,0	44,5	132,0	15,0	50/25	RH50 B500ND	HT81-U RHU81
120	12	2A24-2M12	15,2	28,5	16,0	14,0	44,5	135,5	13,2	50/25		
	14	2A24-2M14	15,2	28,5	18,0	16,0	44,5	139,5	15,0	50/25	RH50 B500ND	HT81-U RHU81
150	16	2A24-2M16	15,2	28,5	18,0	17,0	44,5	140,5	17,0	50/25		
	12	2A30-2M12	16,7	31,5	16,0	14,0	44,5	142,5	13,2	30/15	RH50 B500ND	HT81-U RHU81
185	14	2A30-2M14	16,7	31,5	18,0	16,0	44,5	146,5	15,0	30/15		
	12	2A37-2M12	19,2	35,5	16,0	14,0	44,5	152,5	13,2	30/15	RH50 B500ND	HT81-U RHU81
240	14	2A37-2M14	19,2	35,5	18,0	16,0	44,5	156,5	15,0	30/15		
	16	2A37-2M16	19,2	35,5	19,0	17,0	44,5	158,5	17,0	30/15	RH50 B500ND	HT81-U RHU81
300	12	2A48-2M12	21,1	39,0	16,0	14,0	44,5	153,5	13,2	25/5		
	14	2A48-2M14	21,1	39,0	18,0	16,0	44,5	157,5	15,0	25/5	RH50 B500ND	HT81-U RHU81
400	16	2A48-2M16	21,1	39,0	19,0	17,0	44,5	159,5	17,0	25/5		
	12	2A60-2M12	23,7	44,0	20,0	14,0	44,5	174,0	13,2	15/5	RH50 B500ND	HT81-U RHU81
500	14	2A60-2M14	23,7	44,0	22,0	16,0	44,5	178,0	15,0	20/5		
	16	2A60-2M16	23,7	44,0	19,0	17,0	44,5	176,0	17,0	20/5	RH50 B500ND	HT81-U RHU81
630	12	2A80-2M12	27,0	51,0	20,0	14,0	44,5	177,5	13,2	15/5		
	14	2A80-2M14	27,0	51,0	22,0	16,0	44,5	181,5	15,0	10/5	RH50 B500ND	HT81-U RHU81
800	16	2A80-2M16	27,0	51,0	22,0	19,0	44,5	184,5	17,0	15/5		
	12	2A100-2M12*	30,3	56,5	20,0	14,0	44,5	178,5	13,2	10/5	RH50 B500ND	HT81-U RHU81
1000	14	2A100-2M14*	30,3	56,5	22,0	16,0	44,5	182,5	15,0	10/1		
	16	2A100-2M16*	30,3	56,5	22,0	19,0	44,5	185,5	17,0	8/1	RH50 B500ND	HT81-U RHU81
1000	12	2A120-2M12*	33,4	61,5	20,0	14,0	44,5	196,5	13,2	15/1		
	14	2A120-2M14*	33,4	61,5	22,0	19,0	44,5	200,5	15,0	15/1	RH50 B500ND	HT81-U RHU81
1000	16	2A120-2M16*	33,4	61,5	22,0	19,0	44,5	203,5	17,0	15/1		
	14	2A160-2M14*	38,0	72,0	22,0	19,0	44,5	225,5	15,0	10/1	RH50 B500ND	HT81-U RHU81
1000	16	2A160-2M16*	38,0	72,0	24,0	19,0	44,5	227,5	17,0	10/1		
	12	2A200-2M12*	44,0	80,0	20,0	14,0	44,5	233,5	13,2	6/2	RH50 B500ND	HT81-U RHU81
1000	16	2A200-2M16*	44,0	80,0	22,0	19,0	44,5	240,5	17,0	5/1		
	20	2A200-2M20*	44,0	80,0	24,0	23,0	44,5	246,5	21,0	6/2	RHU520	ECW-H3D

*See page 139

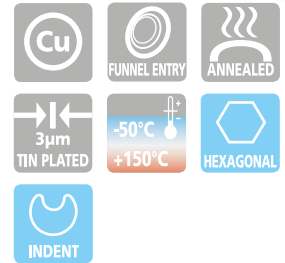

The 2A-2M series cable lugs are designed for heavy duty, for grounding structures and equipment both indoors and outdoors and for medium voltage applications up to 35 kV.

2A-2M series terminals are made from high purity Copper tube with a purity greater than 99.9%, and are annealed.

They feature a double length barrel for enhanced electrical and mechanical performance in heavy duty applications.

The double hole fixing ensures greater mechanical stability even in the presence of electrodynamic stresses.

The absence of an inspection hole prevents the entry of water or moisture into the crimped joint making these terminals suitable for outdoor applications.

The terminals are electrolytically Tin plated to prevent atmospheric corrosion.

Details of the appropriate crimping tools and dies are shown on pages 260 to 261.

*Not UL approved

L-M



L-M range of connectors are designed for jointing low voltage conductors.

Made of electrolytic Copper tube with a purity greater than 99.9%, having the same dimension as A-M series lugs: L-M connectors are annealed and electrolytically Tin plated.

They feature an internal taper at both ends to ease the introduction of the conductor and a central stop to ensure correct positioning. Details of the appropriate crimping tools and dies are shown on pages 260 to 261.

THROUGH CONNECTORS

for Copper conductors

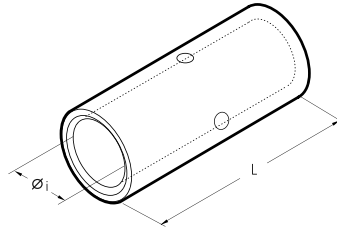

Conductor Size sqmm		Type	Dimensions mm		Quantity Box/Bag	Mechanical Tools	Hydraulic Tools
Low Stranded	Flexible		øi	L			
0,25÷1,5	0,25÷1,5	L03-M*	1,8	15	5.000/100	HN1 HN5 HN-A25 TN70SE TN120 SE* B15MD HT45-E B450ND-BV HT51 RH50 B500 B500ND HT81-U RHU81 HT120 and tools and heads with 130 kN crimping force ECW-H3D RHU520	
1,5÷2,5	1,5÷2,5	L06-M*	2,4	15	4.000/100		
4÷6	4÷6	L1-M	3,6	22	2.000/100		
10	10	L2-M	4,6	25	1.000/100		
16	16	L3-M	5,8	27	500/100		
25	25	L5-M	7,0	29	500/100		
35	25÷35	L7-M	8,9	33	400/100		
50	35÷50	L10-M	10,0	37	200/50		
70	50÷70	L14-M	11,3	39	200/50		
95	70÷95	L19-M	13,5	43	100/25		
120	95÷120	L24-M	15,2	47	75/25		
150	120÷150	L30-M	16,7	58	50/25		
185	150÷185	L37-M	19,2	64	30/15		
240	185÷240	L48-M	21,1	75	20/10		
300	240÷300	L60-M	23,7	90	20/10		
400	300÷400	L80-M	27,0	94	15/5		
500	400÷500	L100-M	30,3	98	12/1		
630	500÷630	L120-M*	33,4	105	10/1		
800	600	L160-M*	38,0	112	6/1		
1000	800	L200-M*	44,0	120	6/1		

*See page 139

L-P



Made of electrolytic Copper tube with a purity greater than 99.9%, having the same dimensions as A-M series lugs, L-P connectors are annealed and electrolytically Tin plated.

They feature an internal taper to ease the introduction of the conductor.

Details of the appropriate crimping tools and dies are shown on pages 260 to 261.

PARALLEL CONNECTORS

for Copper conductors

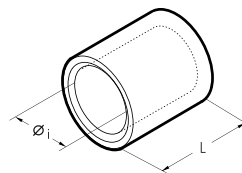

Total Conductor Size sqmm		Type	Dimensions mm		Quantity Box/Bag	Mechanical Tools	Hydraulic Tools
Low Stranded	Flexible		øi	L			
0,25÷1,5	0,25÷1,5	L03-P	1,8	6,0	8.000/100	HN1 HN5 HN-A25 TN70SE TN120 SE* B15MD HT45-E B450ND-BV HT51 RH50 B500 B500ND HT81-U RHU81 HT120 and tools and heads with 130 kN crimping force ECW-H3D RHU520	
1,5÷2,5	1,5÷2,5	L06-P	2,4	6,0	5.000/100		
4÷6	4÷6	L1-P	3,6	9,0	3.000/100		
10	10	L2-P	4,6	10,5	2.000/100		
16	16	L3-P	5,8	11,5	1.500/100		
25	25	L5-P	7,0	13,0	1.000/100		
35	25÷35	L7-P	8,9	14,0	500/100		
50	35÷50	L10-P	10,0	16,0	500/100		
70	50÷70	L14-P	11,3	18,0	500/100		
95	70÷95	L19-P	13,5	19,0	200/50		
120	95÷120	L24-P	15,2	22,0	200/50		
150	120÷150	L30-P	16,7	26,5	100/50		
185	150÷185	L37-P	19,2	26,5	100/50		
240	185÷240	L48-P	21,1	34,0	60/15		
300	240÷300	L60-P	23,7	43,0	50/25		

*See page 139

*Not UL approved

POLYAMIDE PA6.6 INSULATED COPPER TUBE LUGS

ANE-M

for Copper conductors

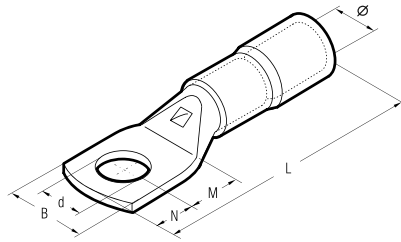

Cond. Size Flexible sqmm	Ø Stud mm	Type	Dimensions mm						Quantity Box/Bag	Mechanical Tools	Hydraulic Tools
			Ø	B	M	N	L	d			
10	4	ANE2-M4	8,0	10,0	5,0	4,0	34,1	4,3	500/100	HNN3	B15MD
	5	ANE2-M5	8,0	10,0	6,5	6,0	37,6	5,3	500/100		
	6	ANE2-M6	8,0	11,0	7,0	6,0	38,1	6,4	500/100		
	8	ANE2-M8	8,0	15,0	9,0	8,0	42,1	8,4	500/100		
	10	ANE2-M10	8,0	18,0	11,0	10,0	46,1	10,5	500/100		
	12	ANE2-M12	8,0	19,0	14,0	12,0	51,1	13,2	500/100		
16	4	ANE3-M4	9,2	11,5	5,0	4,0	38,6	4,3	400/100	HNN4	B15MD
	5	ANE3-M5	9,2	11,5	6,5	6,0	42,1	5,3	400/100		
	6	ANE3-M6	9,2	11,5	7,0	6,0	42,6	6,4	400/100		
	8	ANE3-M8	9,2	15,0	9,0	8,0	46,6	8,4	400/100		
	10	ANE3-M10	9,2	18,0	11,0	10,0	50,6	10,5	300/100		
	12	ANE3-M12	9,2	20,0	14,0	12,0	55,6	13,2	300/100		
25	4	ANE5-M4	11,1	14,0	5,0	4,0	41,0	4,3	300/100	TNN70	B15MD
	5	ANE5-M5	11,1	14,0	6,5	6,0	44,5	5,3	300/100		
	6	ANE5-M6	11,1	14,0	7,0	6,0	45,0	6,4	300/100		
	8	ANE5-M8	11,1	15,0	9,0	8,0	49,0	8,4	300/100		
	10	ANE5-M10	11,1	18,0	11,0	10,0	53,0	10,5	200/100		
	12	ANE5-M12	11,1	21,0	14,0	12,0	58,0	13,2	200/50		
35	6	ANE7-M6	13,6	17,0	7,0	6,0	50,0	6,4	100/50	TNN120	B15MD
	8	ANE7-M8	13,6	17,0	9,0	8,0	54,0	8,4	100/50		
	10	ANE7-M10	13,6	19,0	11,0	10,0	58,0	10,5	100/50		
	12	ANE7-M12	13,6	21,0	14,0	12,0	63,0	13,2	100/50		
50	6	ANE10-M6	13,8	19,0	8,0	7,0	53,0	6,4	150/50	TNN120	B15MD
	8	ANE10-M8	13,8	19,0	9,0	8,0	55,0	8,4	150/50		
	10	ANE10-M10	13,8	20,0	11,5	9,5	59,0	10,5	150/50		
	12	ANE10-M12	13,8	21,0	12,0	12,0	62,0	13,2	150/50		
70	6	ANE14-M6	15,8	21,0	8,0	7,0	61,0	6,4	75/25	TNN120	B15MD
	8	ANE14-M8	15,8	21,0	9,0	8,0	63,0	8,0	75/25		
	10	ANE14-M10	15,8	21,0	11,0	10,0	67,0	10,5	75/25		
	12	ANE14-M12	15,8	22,0	14,0	12,0	72,0	13,2	75/25		
14	ANE14-M14	15,8	25,0	16,0	14,0	76,0	15,0	100/25	TNN120	B15MD	
	8	ANE19-M8	18,0	25,0	9,0	8,0	73,0	8,4			50/25
	10	ANE19-M10	18,0	25,0	11,0	10,0	77,0	10,5			50/25
	12	ANE19-M12	18,0	25,0	14,0	12,0	82,0	13,2			50/25
14	ANE19-M14	18,0	25,0	16,0	14,0	86,0	15,0	50/25	TNN120	B15MD	
	16	ANE19-M16	18,0	27,0	18,0	16,0	80,0	17,0			50/25
	10	ANE24-M10	20,0	28,5	11,0	10,0	77,7	10,5			50/25
	12	ANE24-M12	20,0	28,5	14,0	12,0	86,5	13,2			50/25
14	ANE24-M14	20,0	28,5	16,0	14,0	88,5	15,0	50/25	TNN120	B15MD	
	16	ANE24-M16	20,0	28,5	18,0	16,0	90,5	17,0			50/25
	12	ANE30-M12	23,0	31,5	16,0	14,0	101,0	13,2			20/10
	14	ANE30-M14	23,0	31,5	18,0	16,0	105,0	15,0			30/15
16	ANE30-M16	23,0	31,5	19,0	17,0	107,0	17,0	30/15	TNN120	B15MD	
	20	ANE30-M20	23,0	31,5	22,0	20,0	113,0	21,0			30/15

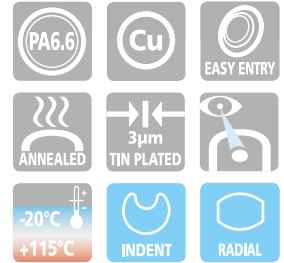

ANE-M series lugs are manufactured from electrolytic Copper tube with a purity greater than 99.9%, annealed and Tin plated. The interior of the PA6.6 insulated sleeve is funnel shaped so as to ensure complete and easy introduction of the conductor strands. It also eliminates the need to insulate the terminal using either tape or heat shrinkable tubing. Furthermore the PA6.6 sleeve avoids the possibility of conductor breakage at the barrel entrance. The operating temperature range is -20 to +115°C (Surge +130°C). In order to achieve the best electrical and mechanical performance it is suggested that they are crimped using dies and tools specifically developed for this purpose by Cembre.

Details of the appropriate crimping tools and dies are shown on pages 262 to 263.

ANE-M

POLYAMIDE PA6.6 INSULATED COPPER TUBE LUGS

for extra flexible Copper conductors

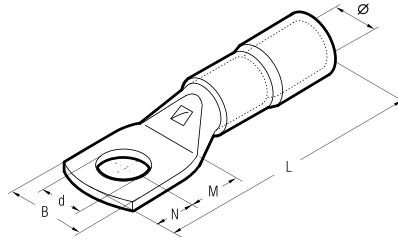

for fine stranded
SPECIAL
flexible conductors



These lugs are particularly recommended for use with extra flexible conductors on for instance, welding machines.

ANE-M series lugs are manufactured from electrolytic Copper tube with a purity greater than 99.9%, annealed and Tin plated.

The interior of the PA6.6 insulated sleeve is funnel shaped so as to ensure complete and easy introduction of the conductor strands.

It also eliminates the need to insulate the terminal using either tape or heat shrinkable tubing.

Furthermore the PA6.6 sleeve avoids the possibility of conductor breakage at the barrel entrance.

The operating temperature range is -20 to +115°C (Surge +130°C).

In order to achieve the best electrical and mechanical performance it is suggested that they are crimped using dies and tools specifically developed for this purpose by Cembre.

Details of the appropriate crimping tools and dies are shown on pages 262 to 263.

Conductor Size Extra Flexible sqmm	Ø Stud mm	Type	Dimensions mm						Quantity Box/Bag	Mechanical Tools	Hydraulic Tools	
			Ø	B	M	N	L	d				
35	6	ANE9-M6/15*	13,6	15,0	8,0	7,0	54,0	6,4	150/50	TNN70	HT51 RH50 B500ND HT120 and heads with 130 kN crimping force ECW-H3D	
	8	ANE9-M8	13,6	17,0	9,0	8,0	56,0	8,4	150/50			
	10	ANE9-M10	13,6	18,5	11,0	10,0	60,0	10,5	150/50			
	12	ANE9-M12	13,6	21,0	14,0	12,0	65,0	13,2	150/50			
50	6	ANE12-M6/15*	15,7	15,0	8,0	7,0	59,5	6,4	50/25			
	8	ANE12-M8	15,7	19,8	9,0	8,0	61,5	8,4	50/25			
	10	ANE12-M10	15,7	19,8	11,0	10,0	65,5	10,5	50/25			
	10	ANE12-M10/19*	15,7	19,0	11,0	10,0	65,5	10,5	50/25			
70	12	ANE12-M12	15,7	22,0	14,0	12,0	70,5	13,2	50/25			TNN120
	6	ANE17-M6	17,9	23,0	8,0	7,0	63,8	6,4	100/25			
	8	ANE17-M8	17,9	23,0	9,0	8,0	65,8	8,4	50/25			
	10	ANE17-M10	17,9	23,0	11,0	10,0	69,8	10,5	50/25			
95	10	ANE17-M10/19*	17,9	19,0	11,0	10,0	69,8	10,5	100/25			
	12	ANE17-M12	17,9	23,0	14,0	12,0	74,8	13,2	50/25			
	14	ANE17-M14	17,9	25,0	15,5	12,0	76,3	15,0	50/25			
	16	ANE17-M16	17,9	27,0	16,5	13,5	78,8	17,0	50/25			
120	8	ANE20-M8	20,0	27,0	9,0	8,0	70,6	8,4	50/25			
	10	ANE20-M10	20,0	27,0	11,0	10,0	74,6	10,5	50/25			
	12	ANE20-M12	20,0	27,0	14,0	12,0	79,6	13,2	50/25			
	14	ANE20-M14	20,0	27,0	15,5	12,0	81,1	15,0	50/25			
150	16	ANE20-M16	20,0	27,0	16,5	13,5	83,6	17,0	50/25			
	10	ANE29-M10	22,4	30,0	11,0	10,0	81,5	10,5	30/15			
	12	ANE29-M12	22,4	30,0	14,0	12,0	86,5	13,2	30/15			
	14	ANE29-M14	22,4	30,0	15,5	12,0	88,5	15,0	50/25			
150	16	ANE29-M16	22,4	30,0	16,5	13,5	90,5	17,0	50/25			
	20	ANE29-M20	22,4	30,0	22,0	20,0	102,5	21,0	40/20			
	12	ANE35-M12	25,0	34,2	16,0	14,0	95,0	13,2	30/15			
	14	ANE35-M14	25,0	34,2	18,0	16,0	99,0	15,0	30/15			
150	16	ANE35-M16	25,0	34,2	19,0	17,0	101,0	17,0	30/15			
	20	ANE35-M20	25,0	34,2	22,0	20,0	107,0	21,0	30/15			

POLYAMIDE PA6.6 INSULATED FORK TERMINALS

for Copper conductors

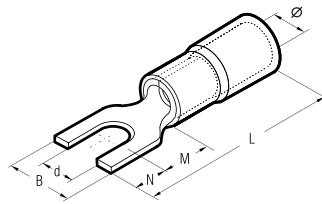

Conductor Size Flexible sqmm	Ø Stud mm	Type	Dimensions mm						Quantity Box/Bag	Mechanical Tools		Hydraulic Tools					
			Ø	B	M	N	L	d									
10	4	ANE2-U4	8,0	9,8	7,5	7,0	35,1	4,3	500/100	HNN3	HNN4	TNN70	TNN120	B15MD	HT51 RH50 B500 B500ND	HT120 and tools and heads with 130 kN crimping force	ECW-H3D
	5	ANE2-U5	8,0	11,5	7,5	7,0	35,1	5,3	500/100								
16	4	ANE3-U4	9,2	10,0	10,0	8,0	41,1	4,3	400/100	HNN3	HNN4	TNN70	TNN120	B15MD	HT51 RH50 B500 B500ND	HT120 and tools and heads with 130 kN crimping force	ECW-H3D
	5	ANE3-U5	9,2	11,5	10,0	8,0	41,1	5,3	400/100								

ANE-U series terminals are made from electrolytic Copper with a purity greater than 99.9%, rolled, Tin plated and brazed. The interior of the PA6.6 insulated sleeve is funnel shaped so as to ensure complete and easy introduction of the conductor strands.

The operating temperature range is -20 to +115°C (Surge +130°C). In order to achieve the best electrical and mechanical performance it is suggested that they are crimped using dies and tools specifically developed for this purpose by Cembre.

Details of the appropriate crimping tools and dies are shown on pages 262 to 263.



UNINSULATED FORK TERMINALS

for Copper conductors

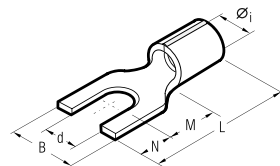

Conductor Size sqmm	Ø Stud mm	Type	Dimensions mm						Quantity Box/Bag	Mechanical Tools		Hydraulic Tools						
			Øi	B	M	N	L	d										
10	4	A2-U4	4,8	9,8	7,5	7,0	23,5	4,3	1.500/100	HNN1	HNN5	TN70SE	TN120SE	B15MD	HT45-E B450ND-BV	HT51 RH50 B500 B500ND	HT120 and tools and heads with 130 kN crimping force	ECW-H3D
	5	A2-U5	4,8	11,5	7,5	7,0	23,5	5,3	1.500/100									
16	4	A3-U4	5,9	10,0	10,0	8,0	28,0	4,3	1.000/100	HNN1	HNN5	TN70SE	TN120SE	B15MD	HT45-E B450ND-BV	HT51 RH50 B500 B500ND	HT120 and tools and heads with 130 kN crimping force	ECW-H3D
	5	A3-U5	5,9	11,5	10,0	8,0	28,0	5,3	1.000/100									



A-U series fork terminals are designed to terminate conductors into contact blocks. Made from electrolytic Copper strip with a purity greater than 99.9%, rolled and Tin plated.

The seam is brazed to provide uniform mechanical strength. The terminal barrel is rifled to enhance electrical contact and to improve mechanical strength. Recommended crimping tools are shown on pages 260 to 261.

ANE-P

POLYAMIDE PA6.6 INSULATED PIN TERMINALS

for Copper conductors

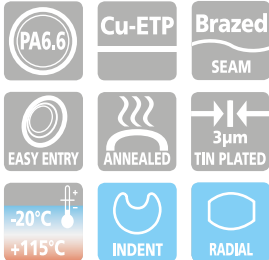
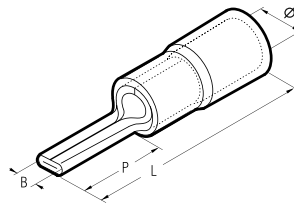

Conductor Size Flexible sqmm	Type	Dimensions mm				Quantity Box/Bag	Mechanical Tools				Hydraulic Tools			
		Ø	B	P	L		HNN3	HNN4	TNN70	TNN120	B15MD	HT51 RH50 B500 B500ND	HT120 and tools and heads with 130 kN crimping force	ECW-H3D
10	ANE2-P12	8,0	4,3	14,5	35,1	500/100	HNN3	HNN4	TNN70	TNN120	B15MD	HT51 RH50 B500 B500ND	HT120 and tools and heads with 130 kN crimping force	ECW-H3D
16	ANE3-P14	9,2	5,5	18,0	41,1	400/100								
25	ANE5-P16	11,1	7,0	20,3	45,0	300/100								
35	ANE7-P20	13,6	8,0	24,5	55,0	150/50								

ANE-P series terminals are made from electrolytic Copper with a purity greater than 99.9%, rolled, Tin plated and brazed. The interior of the PA6.6 insulated sleeve is funnel shaped so as to ensure complete and easy introduc-

tion of the conductor strands. The operating temperature range is -20 to +115°C (Surge +130°C). In order to achieve the best electrical and mechanical performance it is suggested that they are

crimped using tools and dies specifically developed for this purpose by Cembre.

Details of the appropriate crimping tools and dies are shown on pages 262 to 263.

A-P

UNINSULATED PIN CONNECTORS

for Copper conductors

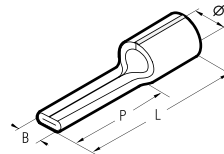

A-P series pin connectors are designed to terminate conductors into contact blocks. They are manufactured from Copper strip with a purity greater than

99.9%, rolled, brazed and Tin plated.

Details of the appropriate crimping tools and dies are shown on pages 260 to 261.

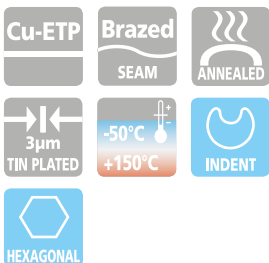

Conductor Size sqmm	Type	Dimensions mm				Quantity Box/Bag	Mechanical Tools				Hydraulic Tools						
		Low Stranded	Flex	Øi	B		P	L	HN1	HN5	HN-A25	TN70SE	TN120SE	B15MD	HT45-E B450ND-BV	HT51 RH50 B500 B500ND	HT120 and tools and heads with 130 kN crimping force
10	10 A2-P12	4,8	4,3	14,5	23,5	1.500/100	HN1	HN5	HN-A25	TN70SE	TN120SE	B15MD	HT45-E B450ND-BV	HT51 RH50 B500 B500ND	HT120 and tools and heads with 130 kN crimping force	ECW-H3D	
16	16 A3-P14	5,9	5,5	18,0	28,0	1.000/100											
25	25 A5-P16	7,0	7,0	20,3	32,0	500/100											
35	25÷35 A7-P20	8,9	8,0	24,5	39,0	500/100											
50	35÷50 A10-P25	10,0	9,5	26,0	45,0	250/50											
70	50÷70 A14-P30	11,5	11,0	31,0	55,0	200/50											

A-PR

UNINSULATED ROUND PIN CONNECTORS

for Copper conductors

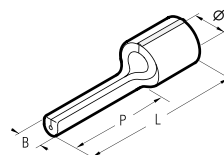

A-PR series pin connectors are designed to terminate conductors into contact blocks. They are manufactured from Copper strip with a purity greater than

99.9%, rolled, brazed and Tin plated.

Details of the appropriate crimping tools and dies are shown on pages 260 to 261.

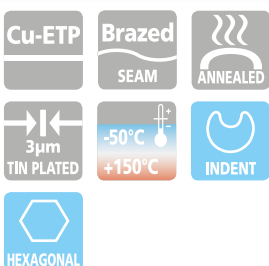

Conductor Size sqmm	Type	Dimensions mm				Quantity Box/Bag	Mechanical Tools				Hydraulic Tools						
		Low Stranded	Flex	Øi	B		P	L	HN1	HN5	HN-A25	TN70SE	TN120SE	B15MD	HT45-E B450ND-BV	HT51 RH50 B500 B500ND	HT120 and tools and heads with 130 kN crimping force
16	16 A3-P22R	5,9	4,0	22,0	32,0	1.000/100	HN1	HN5	HN-A25	TN70SE	TN120SE	B15MD	HT45-E B450ND-BV	HT51 RH50 B500 B500ND	HT120 and tools and heads with 130 kN crimping force	ECW-H3D	
25	25 A5-P22R	7,0	4,0	22,0	33,7	500/100											

UNINSULATED ROUND PIN CONNECTORS ANGLED 45°

for Copper conductors

A-PR/45 series pin connectors are designed to terminate conductors into contact blocks. They are manufactured from Copper strip with a purity greater than

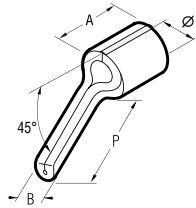

99.9%, rolled, brazed and Tin plated. Details of the appropriate crimping tools and dies are shown on pages 260 to 261.

A-PR/45



Conductor Size sqmm		Type	Dimensions mm				Quantity Box/Bag	Mechanical Tools				Hydraulic Tools					
Low Stranded	Flex		Øi	B	P	A		HN1	HN5	HN-A25	TN/0SE	TN120SE	BT5MD	HT45-E	B450ND-BV		
16	16	A3-P22R/45	5,9	4,0	22,0	10,0	1.000/100						HT51	RH50	B500ND	HT120 and tools and heads with 130 kN crimping force	ECW-H3D
25	25	A5-P22R/45	7,0	4,0	22,0	11,7	500/100										

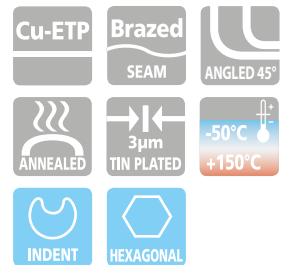

COPPER TUBE LUGS 4-ESI FIXING

for Copper conductors

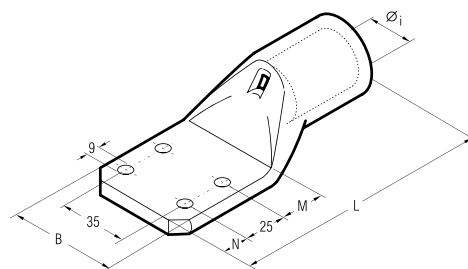

Conductor Size sqmm	Type	Dimensions mm					Quantity Box/Bag	Hydraulic Tools								
		Ø	B	M	N	L		HT51	B550	RH50	B500ND	HT81-U	RHU81	HT 120 and tools and heads with 130 kN crimping force	ECW-H3D	RHU520
185	A 37-4ESI	19,2	61,0	20	15	124	20/10									
240	A 48-4ESI	21,1	61,0	20	15	128	20/10									
300	A 60-4ESI	23,7	61,0	20	15	133	15/5									
400	A 80-4ESI	27,0	61,0	20	15	134	15/5									
500	A 100-4ESI	30,3	61,0	20	15	139	10/5									
630	A 120-4ESI	33,4	61,6	20	15	144	10/5									
800	A 160-4ESI	38,0	61,0	20	15	158	8/1									

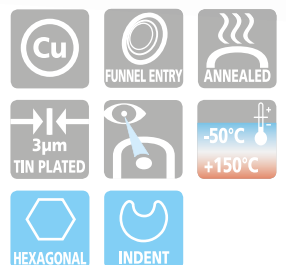

A-4ESI series lugs are made from electrolytic Copper tube with a purity greater than 99.9%, annealed and Tin plated. The four hole stud fixing in accordance with E.A. specifications ensures compatibility with most transformer fixing arrangements.

Details of the appropriate crimping tools and dies are shown on pages 260 to 261.

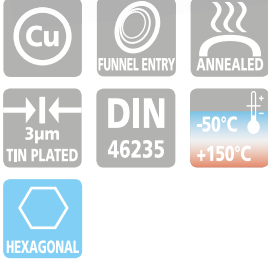
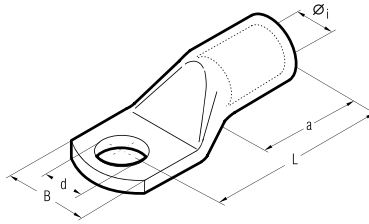

DR series lugs are manufactured from electrolytic Copper tube with a purity greater than 99.9%, and designed to obtain high electrical conductivity combined with the mechanical strength required to resist vibration and pull out.

Cembre lugs are annealed and Tin plated for improved surface protection.

The annealing process optimises the structural features of the material allowing easier crimping and greater resistance to mechanical stresses.

Dimensions are according to DIN 46235.

The barrel entrance of the lug is chamfered to allow easy conductor insertion, while its length facilitates precise positioning in the crimping die.

Each lug is marked with:

- Cembre logo and part code.
- conductor type and csa (mm²).
- stud Ø (mm).
- crimping die code

Details of the appropriate crimping tools and dies are shown on page 268.

Consult us for special requirements

Conductor Size sqmm	Ø Stud mm	Type	Code	Dimensions mm					Quantity Box/Bag	Mechanical Tools	Hydraulic Tools																														
				Øi	d	L	B	a																																	
6	5	DR6-5	5	3,8	5,3	25,0	8,5	10,0	800/100	HN-D25	B15MD																														
	6	DR6-6	5	3,8	6,4	25,0	8,5	10,0	800/100																																
	8	DR6-8*	5	3,8	8,4	25,0	12,5	10,0	800/100																																
10	5	DR10-5	6	4,5	5,3	28,0	9,0	13,0	800/100							TND 6-70																									
	6	DR10-6	6	4,5	6,4	28,0	9,0	13,0	800/100																																
	8	DR10-8*	6	4,5	8,4	28,0	13,0	13,0	800/100																																
16	10	DR10-10*	6	4,5	10,5	28,0	17,0	13,0	800/100												TND 10-120	HT45-E B450ND-BV	HT51 RH50 B500 B500ND	RH60C HT60C B600C B600CND	HT81-U RHU81	HT120 ve diğer 130 kN'luk aletler için	ECW-H3D	RHU520													
	6	DR16-6	8	5,5	6,4	37,0	13,0	20,0	400/100																																
	8	DR16-8	8	5,5	8,4	37,0	13,0	20,0	400/100																																
25	10	DR16-10	8	5,5	10,5	37,0	17,0	20,0	400/100																				TND 6-70												
	12	DR16-12*	8	5,5	13,0	39,0	19,0	20,0	400/100																																
	6	DR25-6	10	7,0	6,4	39,0	14,0	20,0	400/100																																
35	8	DR25-8	10	7,0	8,4	39,0	16,0	20,0	300/100	TND 10-120	HT45-E B450ND-BV	HT51 RH50 B500 B500ND	RH60C HT60C B600C B600CND	HT81-U RHU81	HT120 ve diğer 130 kN'luk aletler için																					ECW-H3D	RHU520				
	10	DR25-10	10	7,0	10,5	39,0	17,0	20,0	200/100																																
	12	DR25-12	10	7,0	13,0	40,0	19,0	20,0	200/100																																
50	6	DR35-6*	12	8,2	6,4	41,0	17,0	20,0	200/100							TND 10-120	HT45-E B450ND-BV	HT51 RH50 B500 B500ND	RH60C HT60C B600C B600CND	HT81-U RHU81																		HT120 ve diğer 130 kN'luk aletler için	ECW-H3D	RHU520	
	8	DR35-8	12	8,2	8,4	43,0	17,0	20,0	200/100																																
	10	DR35-10	12	8,2	10,5	43,0	19,0	20,0	200/100																																
70	12	DR35-12	12	8,2	13,0	43,0	21,0	20,0	200/100												TND 10-120	HT45-E B450ND-BV	HT51 RH50 B500 B500ND	RH60C HT60C B600C B600CND	HT81-U RHU81	HT120 ve diğer 130 kN'luk aletler için	ECW-H3D	RHU520													
	16	DR35-16*	12	8,2	17,0	47,0	26,0	20,0	200/100																																
	6	DR50-6*	14	10,0	6,4	53,0	20,0	28,0	100/25																																
8	8	DR50-8	14	10,0	8,4	53,0	20,0	28,0	100/25																				TND 10-120	HT45-E B450ND-BV	HT51 RH50 B500 B500ND	RH60C HT60C B600C B600CND	HT81-U RHU81	HT120 ve diğer 130 kN'luk aletler için	ECW-H3D						RHU520
	10	DR50-10	14	10,0	10,5	53,0	22,0	28,0	100/25																																
	12	DR50-12	14	10,0	13,0	53,0	24,0	28,0	100/25																																
16	16	DR50-16	14	10,0	17,0	53,0	28,0	28,0	100/25	TND 10-120	HT45-E B450ND-BV	HT51 RH50 B500 B500ND	RH60C HT60C B600C B600CND	HT81-U RHU81	HT120 ve diğer 130 kN'luk aletler için																					ECW-H3D	RHU520				
	8	DR70-8	16	11,5	8,4	56,0	24,0	28,0	50/25																																
	10	DR70-10	16	11,5	10,5	56,0	24,0	28,0	50/25																																
20	12	DR70-12	16	11,5	13,0	56,0	24,0	28,0	50/25							TND 10-120	HT45-E B450ND-BV	HT51 RH50 B500 B500ND	RH60C HT60C B600C B600CND	HT81-U RHU81																		HT120 ve diğer 130 kN'luk aletler için	ECW-H3D	RHU520	
	16	DR70-16	16	11,5	17,0	56,0	30,0	28,0	50/25																																
	20	DR70-20*	16	11,5	21,0	64,0	30,0	28,0	50/25																																
8	8	DR95-8*	18	13,5	8,4	66,0	28,0	35,0	50/25												TND 10-120	HT45-E B450ND-BV	HT51 RH50 B500 B500ND	RH60C HT60C B600C B600CND	HT81-U RHU81	HT120 ve diğer 130 kN'luk aletler için	ECW-H3D	RHU520													
	10	DR95-10	18	13,5	10,5	66,0	28,0	35,0	50/25																																
	12	DR95-12	18	13,5	13,0	66,0	28,0	35,0	50/25																																
16	16	DR95-16	18	13,5	17,0	66,0	32,0	35,0	50/25																				TND 10-120	HT45-E B450ND-BV	HT51 RH50 B500 B500ND	RH60C HT60C B600C B600CND	HT81-U RHU81	HT120 ve diğer 130 kN'luk aletler için	ECW-H3D						RHU520
	20	DR95-20*	18	13,5	21,0	74,0	32,0	35,0	50/25																																
	8	DR120-8*	20	15,5	8,4	71,0	30,0	35,0	50/25																																
10	10	DR120-10	20	15,5	10,5	71,0	32,0	35,0	50/25	TND 10-120	HT45-E B450ND-BV	HT51 RH50 B500 B500ND	RH60C HT60C B600C B600CND	HT81-U RHU81	HT120 ve diğer 130 kN'luk aletler için																					ECW-H3D	RHU520				
	12	DR120-12	20	15,5	13,0	71,0	32,0	35,0	30/15																																
	16	DR120-16	20	15,5	17,0	71,0	32,0	35,0	50/25																																
20	20	DR120-20	20	15,5	21,0	70,5	38,0	35,0	50/25							TND 10-120	HT45-E B450ND-BV	HT51 RH50 B500 B500ND	RH60C HT60C B600C B600CND	HT81-U RHU81																		HT120 ve diğer 130 kN'luk aletler için	ECW-H3D	RHU520	
	10	DR150-10	22	17,0	10,5	79,0	34,0	39,0	30/15																																
	12	DR150-12	22	17,0	13,0	79,0	34,0	39,0	30/15																																
16	16	DR150-16	22	17,0	17,0	79,0	34,0	39,0	40/20												TND 10-120	HT45-E B450ND-BV	HT51 RH50 B500 B500ND	RH60C HT60C B600C B600CND	HT81-U RHU81	HT120 ve diğer 130 kN'luk aletler için	ECW-H3D	RHU520													
	20	DR150-20	22	17,0	21,0	79,0	40,0	39,0	30/15																																
	10	DR185-10	25	19,0	10,5	83,0	37,0	40,0	25/25																																
12	12	DR185-12	25	19,0	13,0	83,0	37,0	40,0	25/25																				TND 10-120	HT45-E B450ND-BV	HT51 RH50 B500 B500ND	RH60C HT60C B600C B600CND	HT81-U RHU81	HT120 ve diğer 130 kN'luk aletler için	ECW-H3D						RHU520
	16	DR185-16	25	19,0	17,0	83,0	37,0	40,0	25/25																																
	20	DR185-20	25	19,0	21,0	83,0	40,0	40,0	25/25																																
10	10	DR240-10*	28	21,5	10,5	92,0	42,0	46,0	20/10	TND 10-120	HT45-E B450ND-BV	HT51 RH50 B500 B500ND	RH60C HT60C B600C B600CND	HT81-U RHU81	HT120 ve diğer 130 kN'luk aletler için																					ECW-H3D	RHU520				
	12	DR240-12	28	21,5	13,0	92,0	42,0	46,0	20/10																																
	16	DR240-16	28	21,5	17,0	93,0	42,0	46,0	20/10																																
20	20	DR240-20	28	21,5	21,0	93,0	45,0	46,0	20/10							TND 10-120	HT45-E B450ND-BV	HT51 RH50 B500 B500ND	RH60C HT60C B600C B600CND	HT81-U RHU81																		HT120 ve diğer 130 kN'luk aletler için	ECW-H3D	RHU520	

* Dimensions of the tube according to DIN 46235; Stud hole not included within the standard.

COPPER TUBE CRIMPING LUGS ACCORDING TO DIN 46235

for Copper conductors

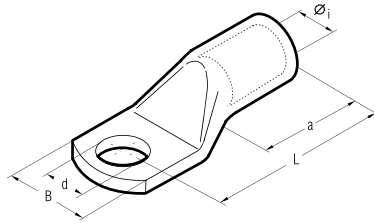

Conductor Size sqmm	Ø Stud mm	Type	Code	Dimensions mm					Quantity Box/Bag	Hydraulic Tools			
				Øi	d	L	B	a		RH50 B500 B500ND	RH60C HT60C B600C B600CND	HT120 and tools and heads with 130 kN crimping force	ECW-H3D RHU520
300	12	DR300-12*	32	24,5	13,0	101,0	48,0	51,0	10/5	ECW-H3D RHU520			
	16	DR300-16	32	24,5	17,0	101,0	48,0	51,0	10/5				
	20	DR300-20	32	24,5	21,0	101,0	48,0	51,0	10/5				
400	12	DR400-12**	38	27,5	13,0	116,0	55,0	70,0	5/5				
	16	DR400-16*	38	27,5	17,0	116,0	55,0	70,0	5/5				
	20	DR400-20*	38	27,5	21,0	116,0	55,0	70,0	5/5				
500	12	DR500-12**	42	31,0	13,0	125,0	60,0	70,0	5/5				
	16	DR500-16**	42	31,0	17,0	125,0	60,0	70,0	5/5				
	20	DR500-20*	42	31,0	21,0	125,0	60,0	70,0	5/5				
625	20	DR625-20*	44	34,5	21,0	136,0	60,0	80,0	5/5				
800	20	DR800-20*	52	40,0	21,0	166,0	75,0	100,0	5/5				
1.000	20	DR1000-20*	58	44,0	21,0	166,0	85,0	100,0	5/5				

* Dimensions of the tube according to DIN 46235; Stud hole not included within the standard.

**Not UL approved

DR



Consult us for special requirements

CRIMPING THROUGH CONNECTORS ACCORDING TO DIN 46267 T.1

for Copper conductors

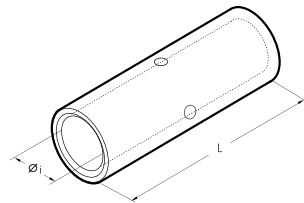

Conductor Size sqmm	Type	Code	Dimensions mm		Quantity Box/Bag	Mechanical Tools	Hydraulic Tools				
			Øi	L			B15MD	HT45-E B450ND-BV	HT51 RH50 B500 B500ND	RH60C HT60C B600C B600CND	HT81-U RHU81
6	DSV6	5	3,7	30	1.200/100	HIN-D25 TND6-70 TND10-120	B15MD HT45-E B450ND-BV HT51 RH50 B500 B500ND RH60C HT60C B600C B600CND HT81-U RHU81	ECW-H3D RHU520			
10	DSV10	6	4,4	30	1.200/100						
16	DSV16	8	5,5	50	400/100						
25	DSV25	10	7,0	50	200/100						
35	DSV35	12	8,2	50	200/100						
50	DSV50	14	10,0	56	200/50						
70	DSV70	16	11,5	56	100/50						
95	DSV95	18	13,5	70	100/50						
120	DSV120	20	15,5	70	50/25						
150	DSV150	22	17,0	80	50/25						
185	DSV185	25	19,0	85	25/25						
240	DSV240	28	21,5	90	15/15						
300	DSV300	32	24,5	100	10/5						
400	DSV400	38	27,5	150	10/5						
500	DSV500	42	31,0	160	5/5						
625	DSV625	44	34,5	160	5/5						
800	DSV800	52	40,0	200	5/5						
1.000	DSV1000	58	44,0	200	5/5						



DSV

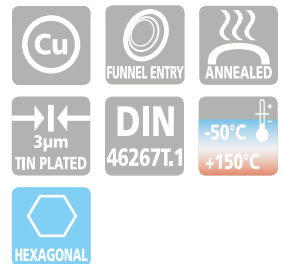

DSV series through connectors are manufactured from electrolytic Copper tube with a purity greater than 99.9%, annealed and surface protected by tin plating. Internal and external dimensions match those of DR series lugs. Chamfered ends and a central stop provide easy and correct insertion of the conductor. Details of the appropriate crimping tools and dies are shown on page 268.

Consult us for special requirements

HR

COPPER TUBE CRIMPING LUGS

for Copper conductors

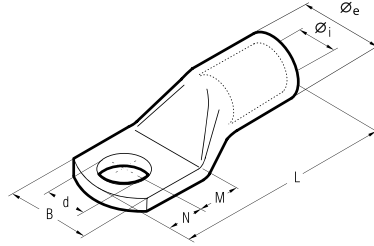

HR series lugs are manufactured from electrolytic Copper tube with a purity greater than 99.9%, and designed to obtain high electrical conductivity combined with the mechanical strength required to resist vibration and pull out.

Cembre lugs are annealed and Tin plated for improved surface protection.

The annealing process optimises the structural features of the material allowing easier crimping and greater resistance to mechanical stresses.

The barrel entrance of the lug is chamfered to allow easy conductor insertion, while its length facilitates precise positioning in the crimping die.

Each lug is marked with:

- Cembre logo and part code.
- conductor type and csa (mm²).
- stud Ø (mm).
- crimping die code

Details of the appropriate crimping tools and dies are shown on page 268.

Consult us for special requirements

Conductor Size sqmm	Ø Stud mm	Type	Dimensions mm							Quantity Box/Bag	Mechanical Tools	Hydraulic Tools	
			Øi	Øe	B	M	N	L	d				
6	4	HR6-4	3,5	6,5	10,0	7,5	6,5	27,5	4,3	800/100	HN1	HN5	B15MD
	5	HR6-5	3,5	6,5	10,0	7,5	6,5	27,5	5,3	800/100			
	6	HR6-6	3,5	6,5	11,5	7,5	6,5	27,5	6,4	800/100			
	8	HR6-8	3,5	6,5	15,0	10,0	10,0	33,5	8,4	800/100			
	10	HR6-10	3,5	6,5	17,0	12,0	12,0	37,5	10,5	800/100			
	12	HR6-12	3,5	6,5	19,0	15,0	13,5	42,0	13,2	800/100			
10	4	HR10-4	4,5	7,0	12,0	7,5	6,5	28,5	4,3	800/100	HN1	HN5	B15MD
	5	HR10-5	4,5	7,0	12,0	7,5	6,5	28,5	5,3	800/100			
	6	HR10-6	4,5	7,0	12,0	7,5	6,5	28,5	6,4	800/100			
	8	HR10-8	4,5	7,0	15,0	10,0	10,0	34,5	8,4	800/100			
	10	HR10-10	4,5	7,0	17,0	12,0	12,0	38,5	10,5	800/100			
	12	HR10-12	4,5	7,0	19,0	13,0	13,0	40,5	13,2	800/100			
16	5	HR16-5	5,5	8,5	12,0	7,0	6,0	31,5	5,3	400/100	HN1	HN5	B15MD
	6	HR16-6	5,5	8,5	12,0	7,5	6,5	32,5	6,4	400/100			
	8	HR16-8	5,5	8,5	15,0	9,5	8,5	36,5	8,4	400/100			
	10	HR16-10	5,5	8,5	17,0	11,5	10,5	40,5	10,5	400/100			
	12	HR16-12	5,5	8,5	19,0	13,0	12,0	43,5	13,2	400/100			
	14	HR16-14	5,5	8,5	21,0	14,5	14,5	47,5	15,0	400/100			
25	5	HR25-5	7,0	10,0	14,0	7,5	7,5	37,0	5,3	400/100	TNH6-70	B15MD	RH181
	6	HR25-6	7,0	10,0	14,0	7,5	7,5	37,0	6,4	400/100			
	8	HR25-8	7,0	10,0	16,0	10,0	10,0	42,0	8,4	400/100			
	10	HR25-10	7,0	10,0	18,0	12,0	12,0	46,0	10,5	400/100			
	12	HR25-12	7,0	10,0	19,0	13,0	13,0	48,0	13,2	400/100			
	14	HR25-14	7,0	10,0	21,0	14,0	14,5	50,5	15,0	400/100			
35	6	HR35-6	8,5	12,0	17,0	7,5	7,5	39	6,4	200/50	TNH6-70	B15MD	RH181
	8	HR35-8	8,5	12,0	17,0	10,0	10,0	44	8,4	200/50			
	10	HR35-10	8,5	12,0	19,0	12,0	12,0	48	10,5	200/50			
	12	HR35-12	8,5	12,0	21,0	13,0	13,0	50	13,2	200/50			
	14	HR35-14	8,5	12,0	21,0	14,5	14,5	53	15,0	200/50			
	16	HR35-16	8,5	12,0	26,0	18,0	18,0	58	17,0	200/50			
50	6	HR50-6	10,0	14,0	20,0	10,0	10,0	47,0	6,4	200/50	TNH10-120	B15MD	RH181
	8	HR50-8	10,0	14,0	20,0	10,0	10,0	47,0	8,4	200/50			
	10	HR50-10	10,0	14,0	20,0	12,0	12,0	51,0	10,5	200/50			
	12	HR50-12	10,0	14,0	23,0	13,0	13,0	53,0	13,2	200/50			
	14	HR50-14	10,0	14,0	23,0	14,5	14,5	56,0	15,0	200/50			
	16	HR50-16	10,0	14,0	28,0	16,0	16,0	59,0	17,0	100/50			
70	20	HR50-20	10,0	14,0	30,0	19,0	19,0	65,0	21,0	100/50	TNH10-120	B15MD	RH181
	6	HR70-6	12,0	16,5	23,5	10,0	10,0	52,0	6,4	100/25			
	8	HR70-8	12,0	16,5	23,5	10,0	10,0	52,0	8,4	100/25			
	10	HR70-10	12,0	16,5	23,5	12,0	12,0	56,0	10,5	80/20			
	12	HR70-12	12,0	16,5	23,5	13,0	13,0	58,0	13,2	80/20			
	14	HR70-14	12,0	16,5	23,5	14,5	14,5	61,0	15,0	80/20			
95	16	HR70-16	12,0	16,5	28,0	16,0	16,0	64,0	17,0	60/15	TNH10-120	B15MD	RH181
	20	HR70-20	12,0	16,5	30,5	19,0	19,0	70,0	21,0	60/15			
	8	HR95-8	13,5	18,0	26,0	12,0	12,0	60,0	8,4	100/25			
	10	HR95-10	13,5	18,0	26,0	12,0	12,0	60,0	10,5	100/25			
	12	HR95-12	13,5	18,0	26,0	13,0	13,0	62,0	13,2	100/25			
	14	HR95-14	13,5	18,0	26,0	14,5	14,5	65,0	15,0	100/25			
120	16	HR95-16	13,5	18,0	28,0	16,0	16,0	68,0	17,0	100/25	TNH10-120	B15MD	RH181
	20	HR95-20	13,5	18,0	36,0	22,0	22,0	80,0	21,0	100/25			
	8	HR120-8	15,0	19,5	28,0	14,0	14,0	65,0	8,4	100/25			
	10	HR120-10	15,0	19,5	28,0	14,0	14,0	65,0	10,5	100/25			
	12	HR120-12	15,0	19,5	28,0	14,0	14,0	65,0	13,2	100/25			
	14	HR120-14	15,0	19,5	28,0	15,0	15,0	67,0	15,0	100/25			
150	16	HR120-16	15,0	19,5	30,0	16,0	16,0	69,0	17,0	100/25	TNH10-120	B15MD	RH181
	20	HR120-20	15,0	19,5	36,0	22,0	22,0	81,0	21,0	50/25			
	8	HR150-8	16,5	21,0	31,0	14,0	14,0	70,0	8,4	40/10			
	10	HR150-10	16,5	21,0	31,0	14,0	14,0	70,0	10,5	40/10			
	12	HR150-12	16,5	21,0	31,0	15,0	15,0	72,0	13,2	40/10			
	14	HR150-14	16,5	21,0	31,0	15,0	15,0	72,0	15,0	40/10			
150	16	HR150-16	16,5	21,0	31,0	16,0	16,0	74,0	17,0	40/10	TNH10-120	B15MD	RH181
	20	HR150-20	16,5	21,0	36,0	22,0	22,0	86,0	21,0	60/15			

COPPER TUBE CRIMPING LUGS

for Copper conductors

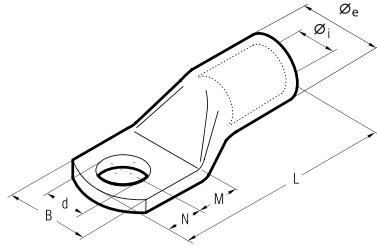

Conductor Size sqmm	Ø Stud mm	Type	Dimensions mm							Quantity Box/Bag	Hydraulic Tools					
			Øi	Øe	B	M	N	L	d		HT51	RH50 B500 B500ND	RH60C B600C B600CND	HT81-U RHU81	HT120 ve diğer 130 kN'luk aletler için	ECW-H3D
185	10	HR185-10	19,0	24,0	35,0	18,0	18,0	83,0	10,5	40/10	HT51	RH50 B500 B500ND	RH60C B600C B600CND	HT81-U RHU81	HT120 ve diğer 130 kN'luk aletler için	ECW-H3D
	12	HR185-12	19,0	24,0	35,0	18,0	18,0	83,0	13,2	40/10						
	14	HR185-14	19,0	24,0	35,0	18,0	18,0	83,0	15,0	40/10						
	16	HR185-16	19,0	24,0	35,0	18,0	18,0	83,0	17,0	40/10						
	20	HR185-20	19,0	24,0	35,0	22,0	22,0	91,0	21,0	40/10						
240	10	HR240-10	21,0	26,0	39,0	19,0	21,5	93,5	10,5	40/10						
	12	HR240-12	21,0	26,0	39,0	19,0	21,5	93,5	13,2	40/10						
	14	HR240-14	21,0	26,0	39,0	19,0	21,5	93,5	15,0	40/10						
	16	HR240-16	21,0	26,0	39,0	19,0	21,5	93,5	17,0	40/10						
	20	HR240-20	21,0	26,0	39,0	19,0	21,5	93,5	21,0	40/10						
300	12	HR300-12	23,5	29,5	43,0	24,0	24,0	111,0	13,2	10/5						
	14	HR300-14	23,5	29,5	43,0	24,0	24,0	111,0	15,0	10/5						
	16	HR300-16	23,5	29,5	43,0	24,0	24,0	111,0	17,0	10/5						
	20	HR300-20	23,5	29,5	43,0	24,0	24,0	111,0	21,0	10/5						

HR

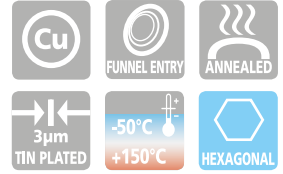

CRIMPING THROUGH CONNECTORS

for Copper conductors

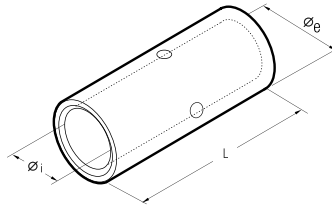

Conductor Size sqmm	Type	Dimensions mm			Quantity Box/Bag	Mechanical Tools				Hydraulic Tools								
		Øi	Øe	L		HN1	HN-5	HN-H25	TNH6-70	TNH10-120	B15MD	HT45-E B450ND-BV	HT51	RH50 B500 B500ND	RH60C B600C B600CND	HT81-U RHU81	HT120 and tools and heads with 130 kN crimping force	ECW-H3D
10	HSV10	4,5	7,0	30	1200/100													
16	HSV16	5,5	8,5	35	800/100													
25	HSV25	7,0	10,0	40	400/100													
35	HSV35	8,5	12,0	45	200/50													
50	HSV50	10,0	14,0	50	200/50													
70	HSV70	12,0	16,5	55	160/40													
95	HSV95	13,5	18,0	60	80/10													
120	HSV120	15,0	19,5	65	80/10													
150	HSV150	16,5	21,0	70	80/10													
185	HSV185	19,0	24,0	75	40/20													
240	HSV240	21,0	26,0	85	40/20													
300	HSV300	23,5	29,5	100	20/10													

HSV

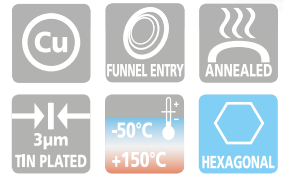

HSV series through connectors are manufactured from electrolytic Copper tube with a purity greater than 99.9%, annealed and surface protected by tin plating. Internal and external dimensions match those of HR series lugs. Chamfered ends and a central stop provide easy and correct insertion of the conductor. Details of the appropriate crimping tools and dies are shown on page 268.

Consult us for special requirements

T-M

COPPER TUBE CRIMPING LUGS ACCORDING TO NF C 20-130

for Copper conductors

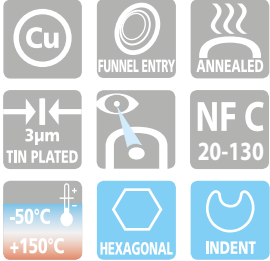
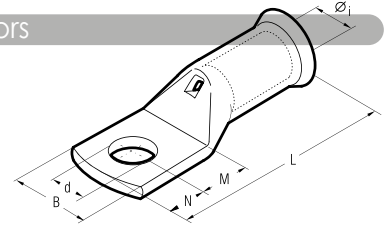

T-M series lugs are manufactured from electrolytic Copper tube with a purity greater than 99.9%.

The dimensions of the tube are designed to obtain the most efficient electrical conductivity and mechanical strength to resist vibration and pull out.

Cembre lugs are annealed to guarantee optimum ductility which is an absolute necessity for connectors which will have to withstand the severe deformation arising when compressed and any bending of the palm during installation. In applications subject to vibration, lugs still have to provide a reliable connection and annealing plays a vital role in avoiding cracking or breaks between the barrel and palm.

The insertion of the cable is facilitated by a tulip out.

The presence of an inspection hole facilitates full insertion of the conductor, whilst the barrel length has been designed to allow easy and accurate positioning of the dies during the crimping operation.

Lugs are electrolytically Tin plated to avoid oxidation.

Our technicians are always available to provide any technical advice which may be required.

The enclosed table is only indicative of the range and many variations in stud fixing and palm lengths are also available.

Details of the appropriate crimping tools and dies are shown on page 270.

Conductor Size sqmm	Low Str.	Flex	Ø Stud mm	Type	Dimensions mm						Quantity Box/Bag	Mechanical Tools	Hydraulic Tools
					Øi	B	M	N	L	d			
4			4	T4-M4	2,7	9,0	7,0	6,0	27,5	4,2	1.200/100	B15MD	
			5	T4-M5	2,7	9,0	7,0	6,0	27,5	5,2	2.000/100		
			6	T4-M6	2,7	12,0	9,0	8,0	32,0	6,4	1.200/100		
4÷6			4	T6-M4	3,3	10,0	6,5	6,0	30,0	4,2	1.200/100	B15MD	
			5	T6-M5	3,3	13,0	6,5	6,0	30,0	5,2	1.200/100		
			6	T6-M6	3,3	13,0	9,0	8,0	34,5	6,4	800/100		
10			8	T6-M8	3,3	13,0	11,0	10,0	38,5	8,3	800/100	B15MD	
			5	T10-M5	4,2	11,0	6,5	6,0	30,0	5,2	800/100		
			6	T10-M6	4,2	11,0	9,0	8,0	34,5	6,4	800/100		
16			8	T10-M8	4,2	14,0	11,0	10,0	38,5	8,3	800/100	B15MD	
			5	T16-M5	5,3	12,0	6,5	6,0	34,0	5,2	800/100		
			6	T16-M6	5,3	12,0	9,0	8,0	38,5	6,4	400/100		
25			8	T16-M8	5,3	16,0	11,0	10,0	42,5	8,3	400/100	B15MD	
			10	T16-M10	5,3	16,0	14,0	12,0	47,5	10,3	400/100		
			5	T25-M5	6,6	13,0	6,5	6,0	35,5	5,2	400/100		
35			6	T25-M6	6,6	13,0	9,0	8,0	40,0	6,4	400/100	B15MD	
			8	T25-M8	6,6	16,0	11,0	10,0	44,0	8,3	400/100		
			10	T25-M10	6,6	16,0	14,0	12,0	49,0	10,3	400/100		
50			12	T25-M12	6,6	19,0	18,0	16,0	57,0	12,8	200/50	B15MD	
			6	T35-M6	7,9	15,0	9,0	8,0	41,0	6,4	200/50		
			8	T35-M8	7,9	17,0	11,0	10,0	45,0	8,3	200/50		
70			10	T35-M10	7,9	17,0	14,0	12,0	50,0	10,3	200/50	B15MD	
			12	T35-M12	7,9	17,0	18,0	16,0	58,0	12,8	200/50		
			6	T50-M6	9,2	18,0	9,0	8,0	46,5	6,4	200/25		
95			8	T50-M8	9,2	18,0	11,0	10,0	50,5	8,3	200/25	B15MD	
			10	T50-M10	9,2	18,0	14,0	12,0	55,5	10,3	200/25		
			12	T50-M12	9,2	19,0	18,0	16,0	63,5	12,8	100/25		
120			8	T70-M8	11,0	21,0	11,0	10,0	54,0	8,3	100/25	B15MD	
			10	T70-M10	11,0	21,0	14,0	12,0	59,0	10,3	100/25		
			12	T70-M12	11,0	21,0	18,0	16,0	67,0	12,8	100/25		
150			8	T95-M8	13,1	23,0	11,0	10,0	60,0	8,3	80/20	B15MD	
			10	T95-M10	13,1	23,0	14,0	12,0	65,0	10,3	80/20		
			12	T95-M12	13,1	23,0	18,0	16,0	73,0	12,8	80/20		
185			14	T95-M14	13,1	23,0	18,0	16,0	73,0	14,5	80/20	B15MD	
			16	T95-M16	13,1	23,0	19,0	17,0	75,0	16,5	80/20		
			8	T120-M8	14,5	28,0	11,0	10,0	63,0	8,3	100/25		
240			10	T120-M10	14,5	28,0	14,0	12,0	68,0	10,3	50/25	B15MD	
			12	T120-M12	14,5	28,0	18,0	16,0	76,0	12,8	50/25		
			14	T120-M14	14,5	28,0	18,0	16,0	76,0	14,5	50/25		
300			16	T120-M16	14,5	28,0	19,0	17,0	78,0	16,5	50/25	B15MD	
			8	T150-M8	16,2	30,0	11,0	10,0	72,5	8,3	40/10		
			10	T150-M10	16,2	30,0	14,0	12,0	77,5	10,3	40/10		
400			12	T150-M12	16,2	30,0	18,0	16,0	85,5	12,8	40/10	B15MD	
			14	T150-M14	16,2	30,0	18,0	16,0	85,5	14,5	40/10		
			16	T150-M16	16,2	30,0	19,0	17,0	87,5	16,5	40/10		
480			10	T185-M10	18,0	33,0	14,0	12,0	83,5	10,3	40/10	B15MD	
			12	T185-M12	18,0	33,0	18,0	16,0	91,5	12,8	40/10		
			14	T185-M14	18,0	33,0	18,0	16,0	91,5	14,5	40/10		
560			16	T185-M16	18,0	33,0	19,0	17,0	93,5	16,5	40/10	B15MD	
			10	T240-M10	20,6	37,0	13,0	11,0	87,5	10,3	20/10		
			12	T240-M12	20,6	37,0	16,0	14,0	93,5	12,8	20/10		
630			14	T240-M14	20,6	37,0	18,0	16,0	97,5	14,5	20/10	B15MD	
			16	T240-M16	20,6	37,0	19,0	17,0	99,5	16,5	20/10		
			20	T240-M20	20,6	37,0	22,0	20,0	105,5	21,0	20/10		
720			10	T300-M10	23,1	41,0	14,0	11,0	95,0	10,3	20/5	B15MD	
			12	T300-M12	23,1	41,0	20,0	14,0	104,0	12,8	20/5		
			14	T300-M14	23,1	41,0	22,0	16,0	108,0	14,5	20/5		
840			16	T300-M16	23,1	41,0	22,0	19,0	111,0	16,5	20/5	B15MD	
			20	T300-M20	23,1	41,0	24,0	23,0	117,0	21,0	10/5		
			14	T400-M14	26,1	47,0	22,0	19,0	119,0	14,5	10/5		
960			16	T400-M16	26,1	47,0	22,0	19,0	119,0	16,5	10/5	B15MD	
			20	T400-M20	26,1	47,0	24,0	23,0	125,0	21,0	10/5		

COPPER TUBE CRIMPING LUGS ANGLED 90°

for Copper conductors

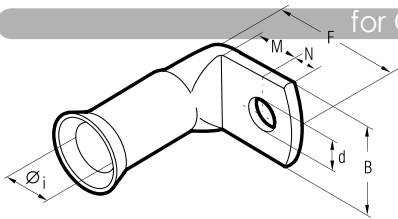

Conductor Size sqmm		Type	Dimensions mm						Quantity Box/Bag	Mechanical Tools	Hydraulic Tools
Low Str.	Flex		øi	B	M	N	F*	d			
4÷6	6	T6-L6	3,3	13,0	9,0	8,0	23,6	6,4	800/100	HNT	B15MD
	5	T10-L5	4,2	11,0	6,0	6,0	20,3	5,2			
10	6	T10-L6	4,2	11,0	8,0	8,0	24,8	6,4	800/100	HNS	B15MD
	8	T10-L8	4,2	14,0	11,0	10,0	28,8	8,3			
16	6	T16-L6	5,3	12,0	9,0	8,0	26,5	6,4	400/100	HN-T25	B15MD
	8	T16-L8	5,3	16,0	11,0	10,0	30,5	8,3			
25	6	T25-L6	6,6	13,0	9,0	8,0	28,0	6,4	400/100	TNF6-50	B15MD
	8	T25-L8	6,6	16,0	11,0	10,0	32,0	8,3			
35	6	T35-L6	7,9	15,0	9,0	8,0	29,5	6,4	400/50	TNF6-120	B15MD
	8	T35-L8	7,9	17,0	11,0	10,0	33,5	8,3			
50	6	T50-L6	9,2	18,0	9,0	8,0	31,5	6,4	100/25	HT45-E B450ND-BV	B15MD
	8	T50-L8	9,2	18,0	10,0	10,0	35,5	8,3			
70	6	T70-L6	11,0	18,0	9,0	8,0	31,5	6,4	100/25	HT51 RH50 B500 B500ND	B15MD
	8	T70-L8	11,0	21,0	11,0	10,0	38,5	8,3			
95	6	T95-L6	13,1	23,0	11,0	10,0	41,0	8,3	100/25	HT81-U RHU81	B15MD
	8	T95-L8	13,1	23,0	14,0	12,0	46,0	10,3			
120	6	T120-L6	14,5	28,0	14,0	12,0	48,0	10,3	50/25	ECW-H3D RHU520	B15MD
	8	T120-L8	14,5	28,0	18,0	16,0	54,0	12,8			
150	6	T150-L6	16,2	30,0	14,0	12,0	50,0	10,3	40/10	HT120 and tools and heads with 130 kN crimping force	B15MD
	8	T150-L8	16,2	30,0	18,0	16,0	58,0	12,8			
185	10	T185-L10	18,0	33,0	14,0	12,0	52,0	10,3	40/10		B15MD

T-L

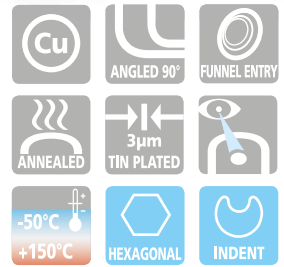

T-L series lugs angled 90° are manufactured from electrolytic Copper tube with a purity greater than 99.9%.

T-L series lugs having the same dimensions and characteristics as T-M series lugs.

F* = indicative dimension

Details of the appropriate crimping tools and dies are shown on page 270.

CRIMPING THROUGH CONNECTORS

for Copper conductors

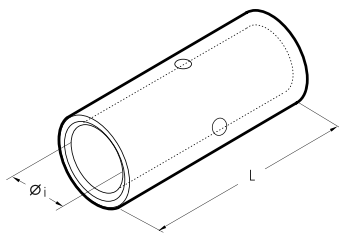

Total Conductor Size sqmm		Type	Dimensions mm		Quantity Box/Bag	Mechanical Tools	Hydraulic Tools
Low Stranded	Flexible		øi	L			
4	4	L4-T	2,7	22	2.000/100	HNT	B15MD
4÷6	4÷6	L6-T	3,3	25	1.500/100	HNS	B15MD
10	10	L10-T	4,2	27	1.000/100	HN-A25	B15MD
16	16	L16-T	5,3	31	500/100	TNF6-50	B15MD
25	25	L25-T	6,6	35	500/100	TNF6-120	B15MD
35	25	L35-T	7,9	37	250/50	HT45-E B450ND-BV	B15MD
50	35	L50-T	9,2	45	250/50	HT51	B15MD
70	50	L70-T	11,0	50	200/50	RH50 B500 B500ND	B15MD
95	70	L95-T	13,1	56	100/25	HT81-U RHU81	B15MD
120	95	L120-T	14,5	60	100/25	HT120 and tools and heads with 130 kN crimping force	B15MD
150	120	L150-T	16,2	66	50/25	ECW-H3D	B15MD
185	150	L185-T	18,0	75	50/25	RHU520	B15MD
240	185	L240-T	20,6	80	30/15		B15MD
300	240	L300-T	23,1	90	20/10		B15MD
400	300	L400-T	26,1	100	20/5		B15MD

L-T



Made of electrolytic Copper tube with a purity greater than 99.9%, having the same dimensions as T-M series lugs, L-T connectors are annealed and electrolytically Tin plated. They feature an internal taper to ease the introduction of the conductor.

Details of the appropriate crimping tools and dies are shown on page 270.



COLOUR CODED COPPER CRIMPING LUGS

for Copper conductors

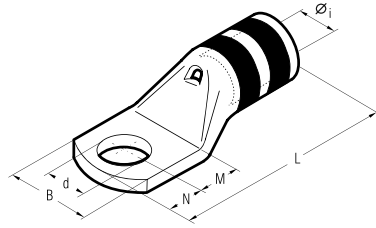

C series lugs are manufactured from electrolytic Copper tube with a purity greater than 99.9%.

The dimensions of the tube are designed to obtain the most efficient electrical conductivity and mechanical strength to resist vibration and pull out.

Cembre lugs are annealed to guarantee optimum ductility, an absolute necessity for connectors which will have to withstand the severe deformation arising when compressed and any bending of the palm during installation.

In applications subject to vibration, terminals have to perform a reliable connection, the annealing process plays a vital role in avoiding cracking or breaks between the barrel and palm.

The presence of an inspection hole facilitates full insertion of the conductor. The barrel length has been designed to allow easy and accurate positioning of the dies during the crimping operation.

Lugs are electrolytically Tin plated to avoid oxidation.

The tongue is clearly marked with wire size and die index for Cembre tools.

UL listed for US and Canada per UL486A up to 35 KV.

C series lugs are an important part of Cembre crimping systems for power carrying conductors.

Details of the appropriate crimping tools and dies are shown on page 269.

Cembre technicians are available to provide technical advice as required.

Please consult Cembre for products not listed.

Cond. Size sqmm	Conductor		Type	Dimensions mm						Colour Code	Quantity Box/Bag	Mechanical Tools	Hydraulic Tools
	AWG	Navy		Ø Stud mm	Øi	B	M	N	L				
10	8	23	4 C8-8	4,6	10,0	5,0	4,0	22,5	4,3	RED	600/50	TN70SE	B15MD
			5 C8-10	4,6	10,0	6,5	6,0	26,0	5,3		600/50		
			6 C8-14	4,6	11,0	7,0	6,0	26,5	6,4		600/50		
			8 C8-516	4,6	15,0	9,0	8,0	30,5	8,4		400/50		
			10 C8-38	4,6	18,0	11,0	10,0	34,5	10,5		600/50		
12 C8-12	4,6	19,0	14,0	12,0	39,5	13,2	600/50						
16	6	40	4 C6-8	5,8	11,5	5,0	4,0	25,5	4,3	BLUE	600/50		
			5 C6-10	5,8	11,5	6,5	6,0	29,0	5,3		600/50		
			6 C6-14	5,8	11,5	7,0	6,0	29,5	6,4		600/50		
			8 C6-516	5,8	15,0	9,0	8,0	33,5	8,4		600/50		
			10 C6-38	5,8	18,0	11,0	10,0	37,5	10,5		600/50		
12 C6-12	5,8	20,0	14,0	12,0	43,5	13,2	400/50						
25	4	40	4 C4-8	6,2	12,5	5,0	4,0	25,5	4,3	GREY	600/50		
			5 C4-10	6,2	12,5	6,5	6,0	29,0	5,3		600/50		
			6 C4-14	6,2	12,5	7,0	6,0	29,5	6,4		600/50		
			8 C4-516	6,2	15,0	9,0	8,0	33,5	8,4		600/50		
			10 C4-38	6,2	18,0	11,0	10,0	37,5	10,5		400/50		
12 C4-12	6,2	20,0	14,0	12,0	42,5	13,2	400/50						
35	2	60	4 C3-8	7,0	14,0	5,0	4,0	28,0	4,3	WHITE	600/50		
			5 C3-10	7,0	14,0	6,5	6,0	31,5	5,3		600/50		
			6 C3-14	7,0	14,0	7,0	6,0	32,0	6,4		600/50		
			8 C3-516	7,0	15,0	9,0	8,0	36,0	8,4		600/50		
			10 C3-38	7,0	18,0	11,0	10,0	40,0	10,5		400/50		
12 C3-12	7,0	21,0	14,0	12,0	45,0	13,2	400/50						
50	1/0	100	5 C2-10	7,6	17,0	6,5	6,0	33,0	5,3	BROWN	400/50		
			6 C2-14	7,6	17,0	7,0	6,0	33,5	6,4		400/50		
			8 C2-516	7,6	17,0	9,0	8,0	37,5	8,4		400/50		
			10 C2-38	7,6	19,0	11,0	10,0	41,5	10,5		400/50		
			12 C2-12	7,6	21,0	14,0	12,0	46,5	13,2		200/50		
70	2/0	125	6 C1-14	8,9	17,0	7,0	6,0	34,5	6,4	GREEN	400/50		
			8 C1-516	8,9	17,0	9,0	8,0	38,5	8,4		400/50		
			10 C1-38	8,9	19,0	11,0	10,0	42,5	10,5		200/50		
			12 C1-12	8,9	21,0	14,0	12,0	47,5	13,2		200/50		
			6 C1/0-14	10,0	19,0	8,0	7,0	40,5	6,4		200/25		
8 C1/0-516	10,0	19,0	9,0	8,0	42,5	8,4	200/25						
10 C1/0-38	10,0	20,0	11,0	10,0	46,5	10,5	200/25						
12 C1/0-12	10,0	21,0	14,0	12,0	51,5	13,2	200/25						
14 C1/0-916	10,0	25,0	16,0	14,0	55,5	15,0	200/25						
16 C1/0-58	10,0	26,0	18,0	16,0	59,5	17,0	200/25						
95	3/0	150	6 C2/0-14	11,3	21,0	8,0	7,0	44,0	6,4	BLACK	200/25		
			8 C2/0-516	11,3	21,0	9,0	8,0	46,0	8,4		200/25		
			10 C2/0-38	11,3	21,0	11,0	10,0	50,0	10,5		200/25		
			12 C2/0-12	11,3	22,0	14,0	12,0	55,0	13,2		200/25		
			14 C2/0-916	11,3	25,0	16,0	14,0	59,0	15,0		100/25		
16 C2/0-58	11,3	26,0	18,0	16,0	63,0	17,0	100/25						
20 C2/0-34	11,3	29,5	22,0	20,0	75,0	21,0	100/25						
95	3/0	150	6 C3/0-14	12,4	23,0	8,0	7,0	45,0	6,4	ORANGE	200/25		
			8 C3/0-516	12,4	23,0	9,0	8,0	47,0	8,4		100/25		
			10 C3/0-38	12,4	23,0	11,0	10,0	51,0	10,5		100/25		
			12 C3/0-12	12,4	24,0	14,0	12,0	56,0	13,2		100/25		
			14 C3/0-916	12,4	27,0	16,0	14,0	60,0	15,0		100/25		
16 C3/0-58	12,4	28,0	18,0	16,0	64,0	17,0	100/25						
20 C3/0-34	12,4	31,5	22,0	20,0	72,0	21,0	100/25						

COLOUR CODED COPPER CRIMPING LUGS

for Copper conductors

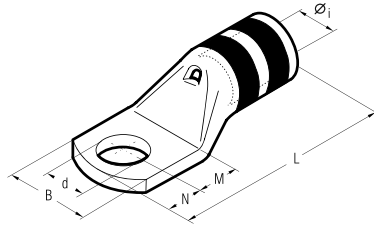

Cond. Size sqmm	Sez. Cond. AWG		Ø Stud mm	Type	Dimensions mm						Colour Code	Quantity Box/Bag	Mechanical Tools	Hydraulic Tools
	Size	Navy			Øi	B	M	N	L	d				
4/0	200	6	C4/0-14	13,5	25,0	8,0	7,0	50,5	6,4	PURPLE	100/25	TNI20SE	HT51 RH50 B500ND HT120 and tools and heads with 130 kN crimping force ECW-H3D RHU520	
		8	C4/0-516	13,5	25,0	9,0	8,0	52,5	8,4		100/25			
		10	C4/0-38	13,5	25,0	11,0	10,0	56,5	10,5		100/25			
		12	C4/0-12	13,5	25,0	14,0	12,0	61,5	13,2		100/25			
		14	C4/0-916	13,5	25,0	16,0	14,0	65,5	15,0		100/25			
		16	C4/0-58	13,5	27,0	18,0	16,0	69,5	17,0		50/25			
120	250 MCM	20	C4/0-34	13,5	29,5	22,0	20,0	77,5	21,0	50/25				
		6	C250-14	15,2	28,5	8,0	7,0	52,0	6,4	YELLOW	100/25			
		8	C250-516	15,2	28,5	9,0	8,0	54,0	8,4		100/25			
		10	C250-38	15,2	28,5	11,0	10,0	58,0	10,5		100/25			
		12	C250-12	15,2	28,5	14,0	12,0	63,0	13,2		50/25			
		14	C250-916	15,2	28,5	16,0	14,0	67,0	15,0		50/25			
16	C250-58	15,2	28,5	18,0	16,0	71,0	17,0	50/25						
150	300 MCM	20	C250-34	15,2	30,0	22,0	20,0	79,0	21,0	50/25				
		22	C250-78	15,2	32,0	24,0	23,0	84,0	23,0	50/25				
		8	C300-516	16,7	31,5	13,0	11,0	69,0	8,4	WHITE	40/10			
		10	C300-38	16,7	31,5	13,0	11,0	69,0	10,5		40/10			
		12	C300-12	16,7	31,5	16,0	14,0	75,0	13,2		40/10			
		14	C300-916	16,7	31,5	18,0	16,0	79,0	15,0		40/10			
16	C300-58	16,7	31,5	19,0	17,0	81,0	17,0	40/10						
20	C300-34	16,7	31,5	22,0	20,0	87,0	21,0	40/10						
185	350 MCM	22	C300-78	16,7	31,5	24,0	23,0	92,0	23,0	40/10				
		10	C350-38	17,6	33,0	13,0	11,0	70,5	10,5	RED	40/20			
		12	C350-12	17,6	33,0	16,0	14,0	76,5	13,2		40/20			
		14	C350-916	17,6	33,0	18,0	16,0	80,5	15,0		40/20			
		16	C350-58	17,6	33,0	19,0	17,0	82,5	17,0		40/20			
		20	C350-34	17,6	33,0	22,0	20,0	88,5	21,0		40/20			
22	C350-78	17,6	37,0	24,0	23,0	93,5	23,0	30/15						
400	400 MCM	10	C400-38	19,2	35,5	13,0	11,0	76,0	10,5	BLUE	40/20			
		12	C400-12	19,2	35,5	16,0	14,0	82,0	13,2		40/20			
		14	C400-916	19,2	35,5	18,0	16,0	86,0	15,0		40/20			
		16	C400-58	19,2	35,5	19,0	17,0	88,0	17,0		40/20			
		20	C400-34	19,2	35,5	22,0	20,0	94,0	21,0		40/20			
		22	C400-78	19,2	35,5	24,0	23,0	99,0	23,0		40/20			
240	500 MCM	10	C500-38	21,1	39,0	13,0	11,0	82,0	10,5	BROWN	30/15			
		12	C500-12	21,1	39,0	16,0	14,0	88,0	13,2		30/15			
		14	C500-916	21,1	39,0	18,0	16,0	92,0	15,0		30/15			
		16	C500-58	21,1	39,0	19,0	17,0	94,0	17,0		30/15			
		20	C500-34	21,1	39,0	22,0	20,0	100,0	21,0		20/10			
		22	C500-78	21,1	39,0	24,0	23,0	105,0	23,0		20/10			
300	600 MCM	12	C600-12	23,7	44,0	20,0	14,0	99,0	13,2	GREEN	20/10			
		14	C600-916	23,7	44,0	22,0	16,0	103,0	15,0		20/10			
		16	C600-58	23,7	44,0	22,0	19,0	106,0	17,0		20/10			
		20	C600-34	23,7	44,0	24,0	23,0	112	21,0		10/5			
750	MCM	22	C600-78	23,7	44,0	24,0	23,0	112,0	23,0	10/5				
		12	C750-12	26,0	48,0	22,0	19,0	113,0	13,2	BLACK	10/5			
		16	C750-58	26,0	48,0	22,0	19,0	113,0	17,0		10/5			
		20	C750-34	26,0	48,0	24,0	23,0	119,0	21,0		10/5			
22	C750-78	26,0	48,0	24,0	23,0	119,0	23,0	10/5						

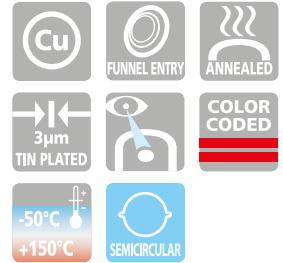

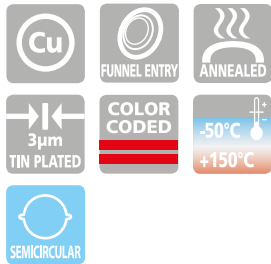
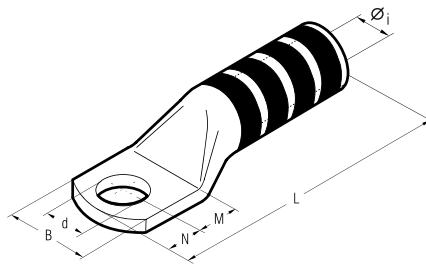

CL series lugs are manufactured from electrolytic Copper tube with a purity greater than 99.9%, for use in heavy duty applications.

The dimensions of the tube are designed to obtain the most efficient electrical conductivity and mechanical strength to resist vibration and pull out.

Cembre lugs are annealed to guarantee optimum ductility which is an absolute necessity for connectors which will have to withstand the severe deformation arising when compressed and any bending of the palm during installation. In applications subject to vibration, terminals have to perform a reliable connection, the annealing process plays a vital role in avoiding cracking or breaks between the barrel and palm.

The long barrel provides better mechanical pull-out strength. Lugs are electrolytically Tin plated to avoid oxidation.

The tongue is clearly marked with wire size and die index for Cembre tools.

UL listed for US and Canada per UL486A up to 35 KV.

CL series lugs are an important part of Cembre crimping systems for power carrying conductors.

Details of the appropriate crimping tools and dies are shown on page 269.

Cembre technicians are available to provide technical advice as required. Please consult Cembre for products not listed.

Cond. Size sqmm	Conductor AWG	Ø Stud mm	Type	Dimensions mm						Colour Code	Quantity Box/Bag	Mechanical Tools	Hydraulic Tools
				Øi	B	M	N	L	d				
10	8	23	5 CL8-10	4,6	10,0	6,5	6,0	37,5	5,3	RED	400/50	TN120SE	HT120 and tools with 130 kN crimping force ECW-H3D RHU520
			6 CL8-14	4,6	11,0	7,0	6,0	38,0	6,4	RED	400/50		
			10 CL8-38	4,6	18,0	11,0	10,0	46,0	10,5	RED	400/50		
16	6	40	5 CL6-10	5,8	11,5	6,5	6,0	40,0	5,3	BLUE	400/50		
			6 CL6-14	5,8	11,5	7,0	6,0	40,5	6,4	BLUE	400/50		
			12 CL6-12	5,8	20,0	14,0	12,0	53,5	13,2	BLUE	400/50		
25	4	50	5 CL4-10	6,2	12,5	6,5	6,0	47,0	5,3	GREY	400/50		
			6 CL4-14	6,2	12,5	7,0	6,0	47,5	6,4	GREY	400/50		
			10 CL4-38	6,2	18,0	11,0	10,0	55,5	10,5	GREY	400/50		
35	2	60	12 CL4-12	6,2	20,0	14,0	12,0	60,5	13,2	GREY	400/50		
			6 CL3-14	7,0	14,0	7,0	6,0	47,5	6,4	WHITE	200/100		
			8 CL3-516	7,0	15,0	9,0	8,0	51,5	8,4	WHITE	200/100		
50	1/0	100	10 CL3-38	7,0	18,0	11,0	10,0	55,5	10,5	WHITE	200/100		
			12 CL3-12	7,0	21,0	14,0	12,0	60,5	13,2	WHITE	200/100		
			5 CL2-10	7,6	17,0	6,5	6,0	46,0	5,3	BROWN	200/50		
70	2/0	125	6 CL2-14	7,6	17,0	7,0	6,0	46,5	6,4	BROWN	200/50		
			8 CL2-516	7,6	17,0	9,0	8,0	50,5	8,4	BROWN	200/50		
			12 CL2-12	7,6	21,0	14,0	12,0	59,5	13,2	BROWN	200/50		
95	3/0	150	5 CL1-10	8,9	17,0	6,5	6,0	48,0	5,3	GREEN	200/50		
			8 CL1-516	8,9	17,0	9,0	8,0	52,5	8,4	GREEN	200/50		
			12 CL1-12	8,9	21,0	14,0	12,0	61,5	13,2	GREEN	200/50		
120	250 MCM	250	5 CL1/0-10	10,0	19,0	8,0	7,0	53,5	5,3	PINK	100/50		
			8 CL1/0-516	10,0	19,0	9,0	8,0	55,5	8,4	PINK	100/50		
			10 CL1/0-38	10,0	20,0	11,0	10,0	59,5	10,5	PINK	100/50		
150	300 MCM	300	12 CL1/0-12	10,0	21,0	14,0	12,0	64,5	13,2	PINK	100/50		
			10 CL2/0-38	11,3	21,0	11,0	10,0	67,5	10,5	BLACK	100/50		
			12 CL2/0-12	11,3	22,0	14,0	12,0	72,5	13,2	BLACK	100/50		
185	350 MCM	350	12 CL3/0-12	12,4	24,0	14,0	12,0	71,5	13,2	ORANGE	100/50		
			10 CL4/0-38	13,5	25,0	11,0	10,0	73,5	10,5	PURPLE	60/30		
			12 CL4/0-12	13,5	25,0	14,0	12,0	78,5	13,2	PURPLE	60/30		
240	500 MCM	400	12 CL250-12	15,2	28,5	14,0	12,0	84,0	13,2	YELLOW	50/25		
			12 CL300-12	16,7	31,5	16,0	14,0	98,0	13,2	WHITE	30/15		
			12 CL350-12	17,6	33,0	16,0	14,0	98,0	13,2	RED	30/15		
300	600 MCM	400	12 CL400-12	19,2	35,5	16,0	14,0	107,0	13,2	BLUE	20/10		
			16 CL400-58	19,2	35,5	19,0	17,0	113,0	17,0	BLUE	20/10		
			12 CL500-12	21,1	39,0	16,0	14,0	108,0	13,2	BROWN	20/10		
300	750 MCM	400	16 CL500-58	21,1	39,0	19,0	17,0	114,0	17,0	BROWN	20/10		
			12 CL600-12	23,7	44,0	20,0	14,0	128,5	13,2	GREEN	10/5		
			16 CL600-58	23,7	44,0	22,0	19,0	135,5	17,0	GREEN	10/5		
300	750 MCM	400	12 CL750-12	26,0	48,0	22,0	19,0	140,5	13,2	BLACK	10/5		
			16 CL750-58	26,0	48,0	22,0	19,0	140,5	17,0	BLACK	10/5		

Also available with inspection hole.
In case of order, add suffix IH to the part number.
E.g.: CL250IH-12

COLOUR CODED COPPER CRIMPING LUGS

CL-D

double hole long barrel - for Copper conductors

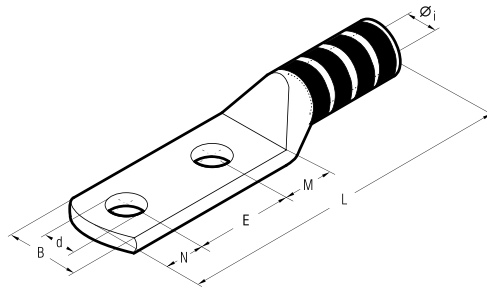

Cond. Size sqmm	Conductor AWG Size	Ø Stud mm	Type	Dimensions mm							Colour Code	Quantity Box/Bag	Mechanical Tools	Hydraulic Tools						
				Øi	B	M	E	N	L	d										
10	8	23	6 CL8-D14	4,6	11,0	7,0	16,0	6,0	53,0	6,4	RED	400/50	B15MD							
			6 CL8-D141	4,6	11,0	7,0	19,0	6,0	56,0	6,4	RED	400/50								
			10 CL8-D38	4,6	18,0	11,0	25,5	10,0	70,5	10,5	RED	400/50								
16	6	40	6 CL6-D14	5,8	11,5	7,0	16,0	6,0	54,5	6,4	BLUE	400/50			B15MD					
			6 CL6-D141	5,8	11,5	7,0	19,0	6,0	57,5	6,4	BLUE	400/50								
			10 CL6-D38	5,8	18,0	11,0	25,5	10,0	72,0	10,5	BLUE	400/50								
25	4	60	6 CL4-D14	6,2	12,5	7,0	16,0	6,0	62,0	6,4	GREY	200/50					B15MD			
			6 CL4-D141	6,2	12,5	7,0	19,0	6,0	65,0	6,4	GREY	200/50								
			10 CL4-D38	6,2	18,0	11,0	25,5	10,0	79,5	10,5	GREY	200/50								
35	2	125	6 CL2-D14	7,6	17,0	7,0	16,0	6,0	61,0	6,4	BROWN	200/50							B15MD	
			6 CL2-D141	7,6	17,0	7,0	19,0	6,0	64,0	6,4	BROWN	200/50								
			10 CL2-D38	7,6	19,0	11,0	25,5	10,0	78,5	10,5	BROWN	100/50								
50	1/0	200	6 CL1-D14	8,9	17,0	7,0	16,0	6,0	63,0	6,4	GREEN	200/50	B15MD							
			6 CL1-D141	8,9	17,0	7,0	19,0	6,0	66,0	6,4	GREEN	200/50								
			10 CL1-D38	8,9	19,0	11,0	25,5	10,0	80,5	10,5	GREEN	100/25								
70	2/0	300	6 CL1/0-D14	10,0	19,0	7,9	16,0	7,0	68,0	6,4	PINK	100/25			B15MD					
			6 CL1/0-D141	10,0	19,0	7,9	19,0	7,0	71,0	6,4	PINK	100/25								
			10 CL1/0-D38	10,0	20,0	10,9	25,5	10,0	83,5	10,5	PINK	100/25								
95	3/0	400	6 CL2/0-D14	11,3	21,0	7,8	16,0	7,0	76,0	6,4	BLACK	60/30					B15MD			
			6 CL2/0-D141	11,3	21,0	7,8	19,0	7,0	79,0	6,4	BLACK	60/30								
			10 CL2/0-D38	11,3	21,0	11,0	25,5	10,0	91,5	10,5	BLACK	60/30								
120	MCM	500	6 CL3/0-D141	12,4	23,3	8,0	19,0	7,0	82,0	6,4	ORANGE	60/30							B15MD	
			10 CL3/0-D38	12,4	23,3	11,0	25,5	10,0	94,5	10,5	ORANGE	60/30								
			12 CL3/0-DN	12,4	24,0	14,0	44,5	12,0	118,5	13,2	ORANGE	60/30								
150	MCM	600	6 CL4/0-D141	13,5	25,0	13,0	19,0	11,0	94,0	6,4	PURPLE	50/25	B15MD							
			10 CL4/0-D38	13,5	25,0	11,0	25,5	10,0	97,5	10,5	PURPLE	50/25								
			10 CL4/0-DN38	13,5	25,0	11,0	44,5	10,0	116,5	10,5	PURPLE	50/25								
185	MCM	750	6 CL4/0-DN	13,5	25,0	14,0	44,5	12,0	121,5	13,2	PURPLE	50/25			B15MD					
			10 CL250-D38	15,2	28,5	11,0	25,5	10,0	103,0	10,5	YELLOW	40/20								
			12 CL250-DN	15,2	28,5	14,0	44,5	12,0	127,0	13,2	YELLOW	40/20								
240	MCM	1000	6 CL300-D141	16,7	31,5	13,0	19,0	11,0	116,0	10,5	WHITE	30/15					B15MD			
			10 CL300-D38	16,7	31,5	16,0	44,5	14,0	141,0	13,2	WHITE	30/15								
			12 CL300-DN	16,7	31,5	16,0	44,5	14,0	141,0	13,2	WHITE	30/15								
300	MCM	1500	6 CL350-D141	17,6	33,0	13,0	19,0	11,0	109,5	6,4	RED	30/15							B15MD	
			10 CL350-D38	17,6	33,0	13,0	25,5	11,0	116,0	10,5	RED	30/15								
			12 CL350-DN	17,6	33,0	16,0	44,5	14,0	141,0	13,2	RED	30/15								
300	MCM	2000	6 CL400-D141	19,2	35,5	13,0	19,0	11,0	118,5	6,4	BLUE	20/10	B15MD							
			10 CL400-D38	19,2	35,5	13,0	25,5	11,0	125,0	10,5	BLUE	20/10								
			12 CL400-DN	19,2	35,5	16,0	44,5	14,0	150,0	13,2	BLUE	20/10								
300	MCM	2500	6 CL500-D141	21,1	39,0	13,0	19,0	11,0	119,5	6,4	BROWN	20/10			B15MD					
			10 CL500-D38	21,1	39,0	13,0	25,5	11,0	126,0	10,5	BROWN	10/5								
			12 CL500-DN	21,1	39,0	16,0	44,5	14,0	151,0	13,2	BROWN	10/5								
300	MCM	3000	10 CL600-D38	23,7	44,0	20,0	25,5	11,0	149,5	10,5	GREEN	20/5					B15MD			
			12 CL600-DN	23,7	44,0	20,0	44,5	14,0	171,5	13,2	GREEN	20/5								
			10 CL750-DN38	26,0	48,0	20,0	44,5	11,0	173,5	10,5	BLACK	15/5								
300	MCM	3500	10 CL750-D38	26,0	48,0	20,0	25,5	11,0	154,5	10,5	BLACK	15/5							B15MD	
			12 CL750-DN	26,0	48,0	20,0	44,5	14,0	176,5	13,2	BLACK	15/5								

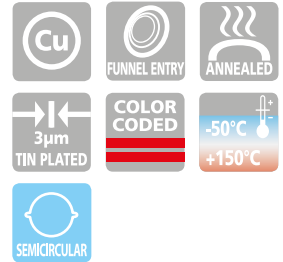

CL series lugs are manufactured from electrolytic Copper tube with a purity greater than 99.9%.

The dimensions of the tube are designed to obtain the most efficient electrical conductivity and mechanical strength to resist vibration and pull out.

Cembre lugs are annealed to guarantee optimum ductility, an absolute necessity for connectors which will have to withstand the severe deformation arising when compressed and any bending of the palm during installation.

In applications subject to vibration, terminals have to perform a reliable connection, the annealing process plays a vital role in avoiding cracking or breaks between the barrel and palm.

The barrel length has been designed to allow easy and accurate positioning of the dies during the crimping operation.

Lugs are electrolytically Tin plated to avoid oxidation.

The tongue is clearly marked with wire size and die index for Cembre tools.

UL listed for US and Canada per UL486A up to 35 KV.

CL series lugs are an important part of Cembre crimping systems for power carrying conductors.

Details of the appropriate crimping tools and dies are shown on page 269.

Cembre technicians are available to provide technical advice as required.

Please consult Cembre for products not listed.

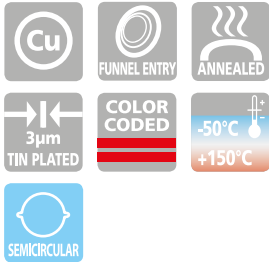
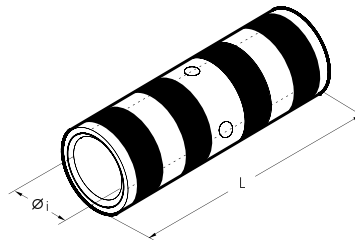

BSCL range of connectors are designed for joining low voltage conductors in heavy duty applications. Made of electrolytic Copper tube with a purity greater than 99.9%, having the same dimension as C and CL series lugs, BSCL connectors are annealed and electrolytically Tin plated.

They feature an internal taper at both ends to ease the introduction of the conductor and a central stop to ensure correct positioning. **UL listed for US and Canada per UL486A up to 35 KV.**

Appropriate crimping tools and dies are shown in details on page 269.

Conductor Size sqmm (AWG)	Conductor Size AWG	Type	Dimensions mm		Colour Code	Quantity Box/Bag	Mechanical Tools			Hydraulic Tools							
			ø1	L			HN1	HN5	TN70	TN120S	B15MD	HT51 RH50 B500ND	HTT120 and tools and heads with 130 kN crimping force	ECW-HBD	RHU520		
10	8	BSCL8	4,6	50,5	RED	600/150											
16	6	BSCL6	5,8	50,5	BLUE	400/100											
25	4	BSCL4	6,2	60,5	GREY	200/100											
	3	BSCL3	7,0	60,5	WHITE	200/50											
35	2	BSCL2	7,6	60,5	BROWN	200/50											
	1	BSCL1	8,9	65,5	GREEN	200/50											
50	1/0	BSCL1/0	10,0	73,0	PINK	200/50											
70	2/0	BSCL2/0	11,3	79,0	BLACK	100/50											
95	3/0	BSCL3/0	12,4	79,0	ORANGE	80/40											
	4/0	BSCL4/0	13,5	85,5	PURPLE	50/25											
120	250 MCM	BSCL250	15,2	85,5	YELLOW	50/25											
150	300 MCM	BSCL300	16,7	104,5	WHITE	40/20											
185	350 MCM	BSCL350	17,6	104,5	RED	40/20											
	400 MCM	BSCL400	19,2	111,0	BLUE	20/10											
240	500 MCM	BSCL500	21,1	117,0	BROWN	20/10											
300	600 MCM	BSCL600	23,7	139,5	GREEN	20/10											
	750 MCM	BSCL750	26,0	149,0	BLACK	10/10											

SLEEVE CONNECTORS

for Copper conductors

C-C

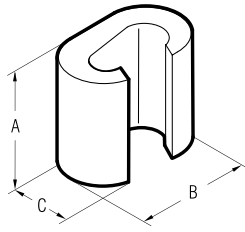

tin plated version

Conductor Size sqmm		Type	Dimensions mm			Quantity Box/Bag	Mechanical Tools	Hydraulic Tools		
Run	Tap		A	B	C			HT45-E B450ND-BV HT45-E B500 B500ND HT51 RH50 RHU81	HT81-U RHU81	ECW-H3D
6÷2,5	6÷1,5	C6-C6ST*	9,0	9,8	6,4	1.000/100	HP4-C10			
10	10÷1,5	C10-C10ST*	12,0	12,6	8,4	500/100				
16	16÷1,5	C16-C16ST	17,0	19,4	12,0	500/100				
25÷16	10÷1,5	C25-C10ST	17,0	19,8	13,0	400/50				
25	25÷16	C25-C25ST	17,0	21,4	13,0	300/50				
40÷35	16÷1,5	C35-C16ST	21,0	24,6	15,4	200/25				
40÷35	40÷25	C35-C35ST	21,0	26,6	15,6	200/25				
50	25÷10									
70÷63	25÷1,5	C70-C25N-ST	21,0	26,4	17,5	200/50				
50	25÷4	C50-C25ST	25,0	32,9	21,0	100/25				
50	50÷35	C50-C50ST	26,0	33,0	21,0	100/25				
70÷50	40÷4	C70-C35ST	28,0	33,0	21,0	100/25				
70÷50	70÷35	C70-C70ST	28,0	34,0	21,0	100/25				
100÷95	40÷4	C95-C35ST	29,0	40,6	26,0	50/25				
100÷95	70÷40	C95-C70ST	29,0	41,0	26,0	50/25				
100÷95	100÷63	C95-C95ST	29,0	41,0	26,0	50/25				
125÷110	125÷25	C120-C120ST	30,0	45,0	28,0	30/15				
160÷150	125÷25	C150-C120ST	31,0	45,0	28,0	50/25				
125	125									
150	150÷63	C150-C150ST	30,0	45,0	28,0	50/25				
125	125									
185	100÷16	C185-C95ST	31,0	45,0	28,0	30/15				
185÷120	185÷120	C185-C185ST	22,6	68,0	34,0	30/15				
240÷150	120÷95	C240-C120ST	22,6	68,0	34,0	30/15				

*Given the small size, on these connectors, only the type is engraved

bright surface version

Conductor Size sqmm		Type	Dimensions mm			Quantity Box/Bag	Mechanical Tools	Hydraulic Tools		
Run	Tap		A	B	C			HT45-E B450ND-BV HT45-E B500 B500ND HT51 RH50 RHU81	HT81-U RHU81	ECW-H3D
6÷2,5	6÷1,5	C6-C6*	9,0	9,8	6,4	1.000/100	HP4-C10			
10	10÷1,5	C10-C10*	12,0	12,6	8,4	500/100				
16	16÷1,5	C16-C16	17,0	19,4	12,0	500/100				
25÷16	10÷1,5	C25-C10	17,0	19,8	13,0	400/50				
25	25÷16	C25-C25	17,0	21,4	13,0	300/50				
40÷35	16÷1,5	C35-C16	21,0	24,6	15,4	200/25				
40÷35	40÷25	C35-C35	21,0	26,6	15,6	200/25				
50	25÷10									
70÷63	25÷1,5	C70-C25N	21,0	26,4	17,5	200/25				
50	25÷4	C50-C25	25,0	32,9	21,0	100/25				
50	50÷35	C50-C50	26,0	33,0	21,0	100/25				
70÷50	40÷4	C70-C35	28,0	33,0	21,0	100/25				
70÷50	70÷35	C70-C70	28,0	34,0	21,0	100/25				
100÷95	40÷4	C95-C35	29,0	40,6	26,0	50/25				
100÷95	70÷40	C95-C70	29,0	41,0	26,0	50/25				
100÷95	100÷63	C95-C95	29,0	41,0	26,0	50/25				
125÷110	125÷25	C120-C120	30,0	45,0	28,0	30/15				
160÷150	125÷25	C150-C120	31,0	45,0	28,0	30/15				
125	125									
150	150÷63	C150-C150	30,0	45,0	28,0	30/15				
125	125									
185	100÷16	C185-C95	31,0	45,0	28,0	50/25				
185÷120	185÷120	C185-C185	22,6	68,0	34,0	30/15				
240÷150	120÷95	C240-C120	22,6	68,0	34,0	30/15				

*Given the small size, on these connectors, only the type is engraved

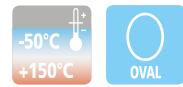

"C" connectors are manufactured from Copper profiles with a purity greater than 99.9%, and are suitable for a variety of uses either to create an earthing network or tapping off from overhead distribution lines. Each connector is marked as follows:

- Cembre trade mark
- Reference number
- Conductor size-Run
- Conductor size-Tap
- Number of crimps
- Die reference.

Details of the appropriate crimping tools and dies are shown on page 264.



Example of tap connection

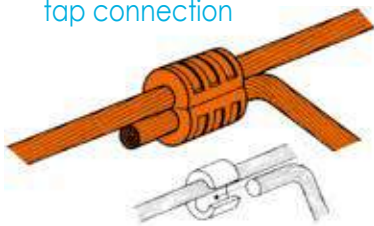

Example of joint connection



Example of joining two running conductors

Conductor Size sqmm	Type
25-25	C35-C16
35-35	C35-C35
50-50	C70-C70
63-63	C95-C70
70-70	
95-95	C150-C120
120-120	C150-C150
120-120	C185-C95
125-125	

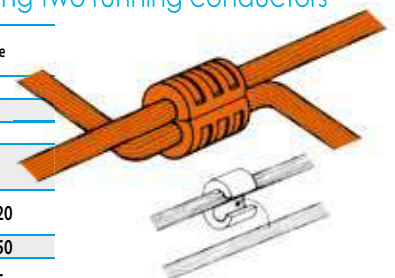

H-H



H clamps are manufactured from Copper profiles with a purity greater than 99.9%, and are suitable for an earthing systems. Each connector is marked as follows:

- Cembre trade mark
- Reference number

features:

- H shape
- For Copper conductors DIN 48201
- Material: Cu ETP (CW004A) according to EN 13605
- Surface: bright and tin plated version
- Electrolytically tin plated to avoid oxidation; min 3µm

H CLAMPS

for Copper conductors

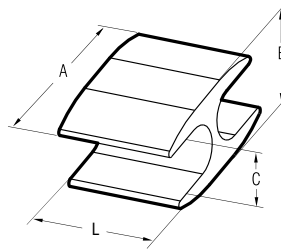

tin plated version

Conductor Size mm ²		Type	Dimensions mm				Quantity	Hydraulic Tools		
Run	Tap		A	B	C	L		HT120 and tools and heads with 130 kN crimping force	ECW-H3D	RHU450
70	70	H70-H70ST	34,0	17,0	10,8	28,0	25			
95	95	H95-H95ST	40,0	22,0	13,0	30,0	25			
120	120	H120-H120ST	43,0	24,0	15,5	25,0	15			

bright surface version

Conductor Size mm ²		Type	Dimensions mm				Quantity	Hydraulic Tools		
Run	Tap		A	B	C	L		HT120 and tools and heads with 130 kN crimping force	ECW-H3D	RHU450
70	70	H70-H70	34,0	17,0	10,8	28,0	25			
95	95	H95-H95	40,0	22,0	13,0	30,0	25			
120	120	H120-H120	43,0	24,0	15,5	25,0	15			

Details of the appropriate crimping tools and dies are shown on page 252.

DK



DK compression cable lugs are made from Copper tube with a purity greater than 99.9% and are suitable for the compression of 2 round conductors.

Cable lugs with an M12 hole or with 2 elongated holes are available (see tables). The elongated holes 2xM12 allow easy assembly with different fastening points. This enables flexible use in earthing systems.

features:

- For copper conductors DIN 48201
- Material: Cu ETP (CW004A) according to EN13605
- Electrolytically tin plated to avoid oxidation; min 3µm
- Marking: Cembre logo; Type, die type (MRD ...- C); Press positions

TWIN CABLE TERMINAL LUGS FOR ROUND CONDUCTORS

for Copper conductors

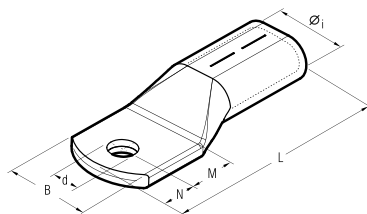

Details of the appropriate crimping tools and dies are shown on page 252.

with an M12 hole

Conductor Size mm ²	Type	Dimensions mm						Quantity	Hydraulic Tools		
		Øi	B	M	N	L	d		HT120 and tools and heads with 130 kN crimping force	ECW-H3D	RHU450
2 x 50	DK50-M12	20,6x10,75	34,0	22,0	14,5	93,5	13,0	10			
2 x 70	DK70-M12	23,0x12,0	37,0	22,0	14,5	97,5	13,0	10			
2 x 95	DK95-M12	26,5x12,8	42,0	23,0	16,0	108,0	13,0	10			
2 x 120	DK120-M12	29,5x15,5	48,0	24,0	14,5	115,5	13,0	5			

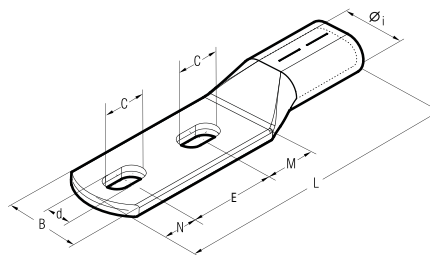

with 2 elongated holes

Conductor Size mm ²	Type	Dimensions mm							Quantity	Hydraulic Tools			
		Øi	B	M	N	E	L	C		d	HT120 and tools and heads with 130 kN crimping force	ECW-H3D	RHU450
2 x 70	DK70-2M12-51AS	23,0x12,0	37,0	25,5	21,5	51,0	159,0	24,0	13,0	10			
2 x 95	DK95-2M12-51AS	26,5x12,8	42,0	25,5	21,5	51,0	167,0	24,0	13,0	10			
2 x 120	DK120-2M12-51AS	29,5x15,5	48,0	25,5	21,5	51,0	175,0	24,0	13,0	10			

MECHANICAL FIXING LUGS

21..

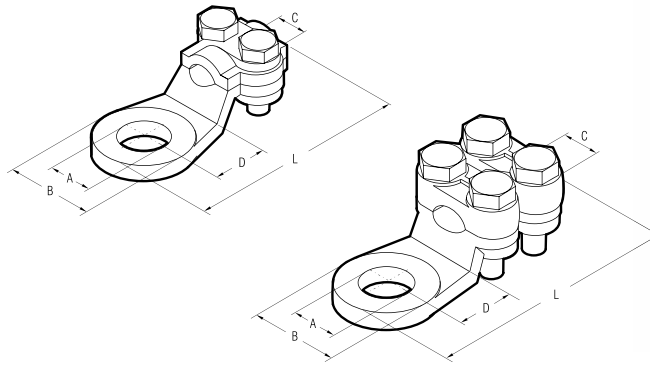

2 bolt fixing lugs

Conductor Size sqmm	Type	Clamping Bolt		Ø A Bolt	Dimensions mm				Quantity
		Ø	Torque Ratio Nm		B	C	D	L	
16	2155	M5	3	M8	18,0	4,5	12,5	39	100
16	2171	M5	3	M10	18,0	4,5	12,5	39	100
25	2156	M5	3	M8	19,5	6,0	13,0	43	100
25	2172	M5	3	M10	19,5	6,0	13,0	43	100
35	2157	M5	3	M12	23,0	7,0	15,0	49	50
35	2173	M5	3	M14	23,0	7,0	15,0	49	50
50	2174	M6	5	M14	25,0	8,0	17,0	56	50



Material:
Brass CB754S EN 1982 Nickel plated.
Zinc plated Steel bolts.

4 bolt fixing lugs

Conductor Size sqmm	Type	Clamping Bolt		Ø A Bolt	Dimensions mm				Quantity
		Ø	Torque Ratio Nm		B	C	D	L	
50	2158	M6	5	M12	23,5	8	16,0	57	50
75	2160	M6	5	M12	28,0	10	20,0	65	25
75	2176	M6	5	M16	28,0	10	20,0	65	25
100	2161*	M6	5	M12	31,0	13	17,0	66	25
125	2162*	M7	10	M15	33,0	14	18,0	71	25
150	2163*	M7	10	M14	34,0	16	19,5	75	25
175	2164*	M7	10	M15	36,0	16	21,0	78	25



* Versions with U-bolts in bent steel

CABLE CLAMPS

23..

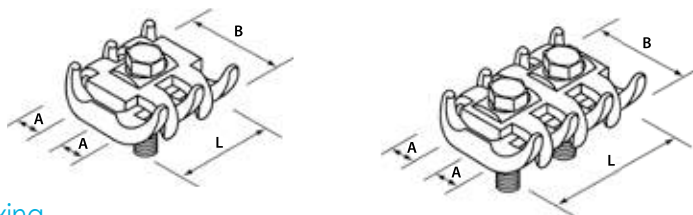

Single bolt fixing

Conductor Size sqmm	Type	Clamping Bolt		A for Cable mm	Dimensions mm		Quantity
		Ø	Torque Ratio Nm		B	L	
6÷16	2323	M6	8	3÷ 5	24	20,0	50
16÷50	2326	M8	15	5÷ 8	32	28,4	50
35÷70	2329	M8	15	7÷12	40	30,0	25



2 bolt fixing

Conductor Size sqmm	Type	Clamping Bolt		A for Cable mm	Dimensions mm		Quantity
		Ø	Torque Ratio Nm		B	L	
6÷16	2333	M6	8	3÷ 5	24,5	30	50
16÷50	2336	M8	15	5÷ 8	32,0	40	50
35÷70	2339	M8	15	7÷12	40,0	44	25
50÷95	2342	M10	35	8÷14	48,0	48	10
95÷150	2344	M10	35	12÷16	51,0	53	10
150÷300	2346*	M12	60	16÷22	66,0	66	5

Material:
Brass CB754S EN 1982
White zinc plated Steel bolts.
White zinc plated Steel nuts.

* Stainless Steel bolts

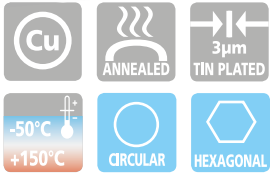
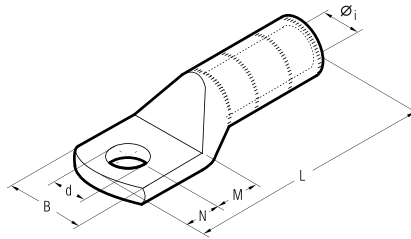

Series CA-M and 2A-M terminals are designed for medium voltage applications up to 35 kV. They are manufactured from Copper tube with a purity greater than 99.9%, annealed and Tin plated. The extended barrel enhances both electrical and mechanical performance. The absence of an inspection hole prevents moisture entry into the crimped joint and makes these terminals suitable for outdoor applications. Details of the appropriate crimping tools and dies are shown on page 264.

Conductor Size (sqmm) & Format	Ø Stud mm	Type	Dimensions mm						Quantity Box/Bag	Hydraulic Tools	
			Øi	B	M	N	L	d			
25 R/BR/BS*	8	CA25-M8	6,8	14,0	9,0	8,0	65,0	8,4	300/50	HT45-E	B450ND-BV
	10	CA25-M10	6,8	18,0	13,0	11,0	72,0	10,5	200/50		
	12	CA25-M12	6,8	21,0	16,0	14,0	78,0	13,2	150/50		
30 RC/S ÷ 40 S	12	CA40S-M12	8,2	21,0	16,0	14,0	79,0	13,2	100/50		
	16	CA40S-M16	8,2	26,0	19,0	17,0	85,0	17,0	100/50		
35 BR/BS*	10	CA35-M10	8,3	21,0	13,0	11,0	73,0	10,5	150/50		
	12	CA35-M12	8,3	21,0	16,0	14,0	79,0	13,2	150/50		
	16	CA35-M16	8,3	26,0	19,0	17,0	85,0	17,0	150/50		
50 RC	12	CA50R-M12	8,7	20,5	16,0	14,0	79,0	13,2	100/50		
50 S	12	CA50S-M12	9,5	21,0	16,0	14,0	79,0	13,2	100/50		
	16	CA50S-M16	9,5	26,0	19,0	17,0	85,0	17,0	100/50		
50 BR/BS*	10	CA50-M10	9,5	21,0	13,0	11,0	73,0	10,5	150/50		
	12	CA50-M12	9,5	21,0	16,0	14,0	79,0	13,2	150/50		
	14	CA50-M14	9,5	25,0	18,0	16,0	83,0	15,0	100/50		
	16	CA50-M16	9,5	26,0	19,0	17,0	85,0	17,0	100/50		
63 S ÷ 70 S	12	CA70S-M12	11,0	28,0	16,0	14,0	81,2	13,2	30/15		
	16	CA70S-M16	11,0	30,0	19,0	17,0	87,2	17,0	50/25		
70 BR/BS*	10	CA70S-M10	11,0	26,0	13,0	11,0	75,2	10,5	50/25		
	12	CA70S-M12	11,0	28,0	16,0	14,0	81,2	13,2	30/15		
	14	CA70S-M14	11,0	28,0	18,0	16,0	85,2	15,0	50/25		
	16	CA70S-M16	11,0	30,0	19,0	17,0	87,2	17,0	50/25		
80 S ÷ 95 RC	12	CA95R-M12	12,0	28,0	16,0	14,0	91,0	13,2	30/15		
	14	CA95R-M14	12,0	29,0	18,0	16,0	95,0	15,0	50/25		
95 S ÷ 100 S	12	CA95S-M12	13,5	28,0	16,0	14,0	91,0	13,2	30/15		
	14	CA95S-M14	13,5	29,0	18,0	16,0	94,5	15,0	50/25		
	16	CA95S-M16	13,5	30,0	20,0	17,0	97,0	17,0	50/25		
95 BR/BS*	10	CA95-M10	13,5	28,0	13,0	11,0	85,0	10,5	50/25		
	12	CA95-M12	13,5	28,0	16,0	14,0	91,0	13,2	50/25		
	16	CA95-M16	13,5	30,0	20,0	17,0	97,0	17,0	50/25		
	12	CA150R-M12	15,0	31,0	16,0	14,0	97,0	13,2	30/15		
120 RC/S ÷ 150 RC	14	CA150R-M14	15,0	31,0	18,0	16,0	101,0	15,0	30/15		
	12	CA120-M12	15,0	31,0	16,0	14,0	97,0	13,2	30/15		
120 BR/BS*	16	CA120-M16	15,0	31,0	19,0	17,0	103,0	17,0	30/15		
	12	CA150S-M12	16,5	32,0	16,0	14,0	97,0	13,2	30/15		
150 S ÷ 160 RC	14	CA150S-M14	16,5	32,0	18,0	16,0	101,0	15,0	30/15		
150 BR/BS*	12	CA150-M12	16,5	32,0	16,0	14,0	97,0	13,2	30/15		
	16	CA150-M16	16,5	32,0	19,0	17,0	103,0	17,0	30/15		
160 S ÷ 200 RC	14	CA200R-M14	17,0	32,5	18,0	16,0	101,0	15,0	30/15		
185 BR/BS*	12	CA185-M12	18,0	33,5	16,0	14,0	97,0	13,2	30/15		
	16	CA185-M16	18,0	33,5	19,0	17,0	103,0	17,0	30/15		
200 S ÷ 240 RC	14	CA240R-M14	19,2	43,0	18,0	16,0	107,0	15,0	15/5		
240 S ÷ 315 RC	14	CA315R-M14	21,5	43,0	18,0	16,0	105,0	15,0	15/5		
	12	CA240-M12	20,5	42,0	16,0	14,0	103,0	13,2	15/5		
240 BR/BS*	16	CA240-M16	20,5	42,0	19,0	17,0	109,0	17,0	15/5		
	20	CA240-M20	20,5	42,0	22,0	20,0	115,0	21,0	15/5		
300 BR/BS*	12	CA300-M12	23,0	43,5	16,0	14,0	109,5	13,2	15/5		
	16	CA300-M16	23,0	43,5	19,0	17,0	115,5	17,0	15/5		
	20	CA300-M20	23,0	43,5	22,0	20,0	121,5	21,0	15/5		
315 S	14	CA315S-M14	23,7	44,0	18,0	16,0	105,0	15,0	15/5		

Conductor Format: R = Round, RC = Round Compact, S = Sector, BR = BS EN 60228 Round, BS* = BS EN 60228 size - Sector shaped
 * = Pre-rounding required, consult Cembre for appropriate die set

MEDIUM VOLTAGE COPPER TERMINALS

CA-2M

two hole fixing

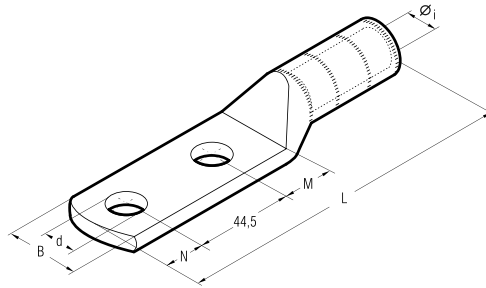

Conductor Size (sqmm) & Format	Ø Stud mm	Type	Dimensions mm					Quantity Box/Bag	Hydraulic Tools	
			Øi	B	M	N	L			d
25 R	8	CA25-2M8	6,8	14,0	10,0	11,0	113,5	8,4	200/50	HT45-E B450ND-BV HT45-E B500ND B550 HT51 RH50 B500 B500ND RHU81 HT120 and tools and heads with 130 kN crimping force ECW-H3D RHU520
	12	CA25-2M12	6,8	21,0	16,0	14,0	122,5	13,2	100/50	
25 BR/BS*	8	CA25-2M8	6,8	14,0	10,0	11,0	113,5	8,4	200/50	
	10	CA25-2M10	6,8	18,0	13,0	11,0	116,5	10,5	150/50	
30 RC/S ÷ 40 S	12	CA40S-2M12	8,2	21,5	16,0	14,0	123,5	13,2	100/50	
35 BR/BS*	12	CA35-2M12	8,3	21,5	16,0	14,0	123,5	13,2	100	
50 RC	12	CA50R-2M12	8,7	20,5	16,0	14,0	123,5	13,2	100/50	
50 S	12	CA50S-2M12	9,5	21,0	16,0	14,0	123,5	13,2	100/50	
50 BR/BS*	12	CA50-2M12	9,5	21,0	16,0	14,0	123,5	13,2	90/3	
63 S ÷ 70 S	12	CA70S-2M12	11,0	27,0	16,0	14,0	125,5	13,2	50/25	
70 BR/BS*	12	CA70S-2M12	11,0	27,0	16,0	14,0	125,5	13,2	50/25	
80 S ÷ 95 RC	14	CA95R-2M14	12,0	28,0	18,0	16,0	139,5	15,0	30/15	
95 S ÷ 100 S	14	CA95S-2M14	13,5	29,0	18,0	16,0	139,5	15,0	30/15	
95 BR/BS*	12	CA95-2M12	13,5	28,0	16,0	14,0	135,5	13,2	30/15	
120 RC/S ÷ 150 RC	14	CA150R-2M14	15,0	31,0	18,0	16,0	145,5	15,0	30/15	
120 BR/BS*	12	CA120-2M12	15,0	31,0	16,0	14,0	141,5	13,2	30/15	
150 S ÷ 160 RC	14	CA150S-2M14	16,5	32,0	18,0	16,0	145,5	15,0	30/15	
150 BR/BS*	12	CA150-2M12	16,5	32,0	16,0	14,0	141,5	13,2	30/15	
160 S ÷ 200 RC	14	CA200R-2M14	17,0	32,5	18,0	16,0	145,0	15,0	30/15	
185 BR/BS*	12	CA185-2M12	18,0	32,5	16,0	14,0	141,5	13,2	30/15	
200 S ÷ 240 RC	14	CA240R-2M14	19,2	43,0	18,0	16,0	151,5	15,0	15/5	
240 S ÷ 315 RC	14	CA315R-2M14	21,5	43,0	18,0	16,0	149,5	15,0	20/5	
240 BR/BS*	12	CA240-2M12	20,5	43,0	16,0	14,0	147,5	13,2	15/5	
300 BR/BS*	12	CA300-2M12	23,0	43,0	16,0	14,0	145,5	13,2	15/5	
315 S	14	CA315S-2M14	23,7	44,0	18,0	16,0	149,5	15,0	20/5	

Conductor Format: R = Round, RC = Round Compact, S = Sector, BR = BS EN 60228 Round, BS* = BS EN 60228 size - Sector shaped
 * = Pre-rounding required, consult Cembre for appropriate die set

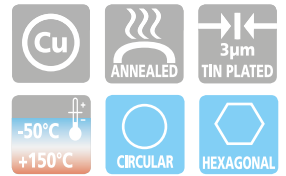

CA-2M and 2A-2M Copper Tube Terminal Lugs are designed for medium voltage applications up to 35 kV. Manufactured from Copper tube with a purity greater than 99.9%, annealed and Tin plated. The extended barrel enhances electrical and mechanical performance.

The absence of an inspection hole prevents moisture entry into the crimped joint. Featuring an extended palm with two fixing holes at 44.5 mm centres.

Details of the appropriate crimping tools and dies are shown on page 264.

MEDIUM VOLTAGE COPPER TERMINALS

2A-2M/55°

palm bent at 55° - two hole fixing

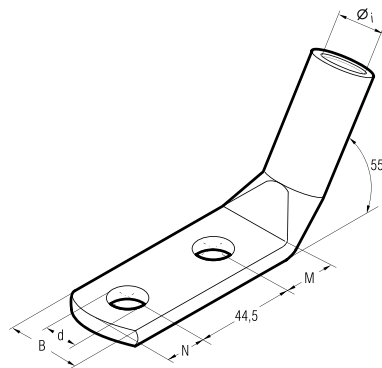

Conductor Size sqmm	Ø Stud mm	Type	Dimensions mm					Quantity Box/Bag	Hydraulic Tools
			Øi	B	M	N	d		
400 R	14	2A80-2M14/55	27,0	51,0	22	16	15	10/5	HT120 and tools and heads with 130 kN crimping force ECW-H3D RHU520
600 R ÷ 630 R	14	2A120-2M14/55	33,4	61,5	22	16	15	15/3	

R = Round conductors



The 2A-2M/55° Copper Tube Terminal Lugs have the same characteristics as the CA-2M and 2A-2M ranges, with the additional feature of the palm bent at 55°.

Details of the appropriate crimping tools and dies are shown on page 264.

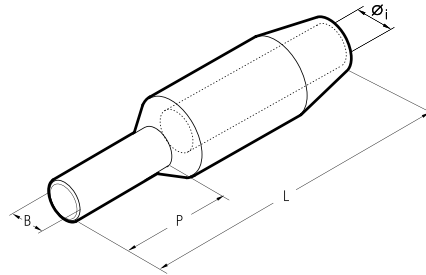

MT-C series connectors are designed for medium voltage applications up to 35 kV.

They are manufactured from Copper with a purity greater than 99.9%, annealed and Tin plated.

The extended barrel enhances both electrical and mechanical performance.

The stalk or pin makes these connectors ideal for terminating conductors into contact blocks.

Details of the appropriate crimping tools and dies are shown on page 264.

Conductor Size (sqmm) & Format	Type	Dimensions mm				Quantity Box/Bag	Hydraulic Tools																								
		Øi	B	P	L																										
25 R	MT25-C8	6,8	8,0	35,0	80,0	90/3	HT45-E	B450ND-BV																							
	MT40S-C8	8,2	8,0	35,0	80,0	90/3																									
30 RC/S ÷ 40 S	MT40S-C10	8,2	10,0	35,0	80,0	90/3						HT51	RH50	B500	ND	B550															
	MT40S-C14-80	8,2	14,0	80,0	123,0	30/3																									
35 BR/BS*	MT35-C8	8,2	8,0	35,0	80,0	90/3											HT81-U	RHU81													
	MT35-C10	8,2	10,0	35,0	80,0	90/3																									
50 RC	MT35-C14-80	8,2	14,0	80,0	123,0	30/3																HT120									
	MT50R-C8	8,8	8,0	35,0	80,0	90/3																									
50 S	MT50R-C10	8,8	10,0	35,0	80,0	90/3																					HT185				
	MT50S-C8	9,5	8,0	35,0	80,0	90/3																									
50 BR/BS*	MT50S-C10	9,5	10,0	35,0	80,0	90/3	HT240																								
	MT50S-C14-80	9,5	14,0	80,0	123,0	30/3																									
63 S ÷ 70 S	MT50-C8	9,5	8,0	35,0	80,0	90/3						HT315																			
	MT50-C10	9,5	10,0	35,0	80,0	90/3																									
70 BR/BS*	MT50-C14-80	9,5	14,0	80,0	123,0	30/3											HT315S														
	MT70S-C10	11,2	10,0	35,0	90,0	30/3																									
80 S ÷ 95 RC	MT70-C10	11,2	10,0	35,0	90,0	30/3																HT185									
	MT95R-C10	12,0	10,0	45,0	110,0	60/3																									
95 S ÷ 100 S	MT95R-C12	12,0	12,0	45,0	110,0	60/3																					HT185				
	MT95S-C10	13,5	10,0	45,0	110,0	60/3																									
95 BR/BS*	MT95S-C12	13,5	12,0	45,0	110,0	60/3	HT185																								
	MT95S-C14-80	13,5	14,0	80,0	145,0	60/3																									
120 RC/S ÷ 150 RC	MT95-C10	13,5	10,0	45,0	110,0	60/3						HT185																			
	MT95-C12	13,5	12,0	45,0	110,0	60/3																									
120 BR/BS*	MT95-C14-80	13,5	14,0	80,0	145,0	60/3											HT185														
	MT150R-C10	15,0	12,0	45,0	110,0	60/3																									
150 S ÷ 160 RC	MT150R-C12	15,0	16,0	45,0	110,0	30/3																HT185									
	MT150R-C16	15,0	16,0	45,0	110,0	30/3																									
150 BR/BS*	MT120-C10	15,0	12,0	45,0	110,0	60/3																					HT185				
	MT120-C12	15,0	12,0	45,0	110,0	60/3																									
160 S ÷ 200 RC	MT120-C16	15,0	16,0	45,0	110,0	60/3	HT185																								
	MT150S-C10	16,5	10,0	45,0	110,0	60/3																									
185 BR/BS*	MT150S-C12	16,5	12,0	45,0	110,0	60/3						HT185																			
	MT150S-C14-80	16,5	14,0	80,0	145,0	45/3																									
200 S ÷ 240 RC	MT150S-C16	16,5	16,0	45,0	110,0	30/3											HT185														
	MT150-C10	16,5	10,0	45,0	110,0	60/3																									
240 S ÷ 315 RC	MT150-C12	16,5	12,0	45,0	110,0	60/3																HT185									
	MT150-C14-80	16,5	14,0	80,0	145,0	45/3																									
240 BR/BS*	MT150-C16	16,5	16,0	45,0	110,0	60/3																					HT185				
	MT200R-C10	17,0	10,0	45,0	110,0	30/3																									
300 BR/BS*	MT200R-C16	17,0	16,0	45,0	110,0	30/3	HT185																								
	MT185-C10	18,0	10,0	45,0	110,0	30/3																									
315 S	MT185-C16	18,0	16,0	45,0	110,0	30/3						HT185																			
	MT240R-C12	19,5	12,0	50,0	115,0	30/3																									
315 S	MT240R-C16	19,5	16,0	50,0	115,0	30/3											HT185														
	MT315R-C16	21,5	16,0	50,0	115,0	30/3																									
240 BR/BS*	MT240-C12	20,5	12,0	45,0	110,0	30/3																HT185									
	MT240-C16	20,5	16,0	50,0	115,0	30/3																									
300 BR/BS*	MT300-C16	23,0	16,0	50,0	115,0	30/3																					HT185				
	MT315S-C16	24,0	16,0	60,0	130,0	30/3																									

Conductor Format: R = Round, RC = Round Compact, S = Sector, BR = BS EN 60228 Round, BS* = BS EN 60228 size - Sector shaped
 * = Pre-rounding required, consult Cembre for appropriate die set

MEDIUM VOLTAGE COPPER THROUGH CONNECTORS

MT-TD MT-GC

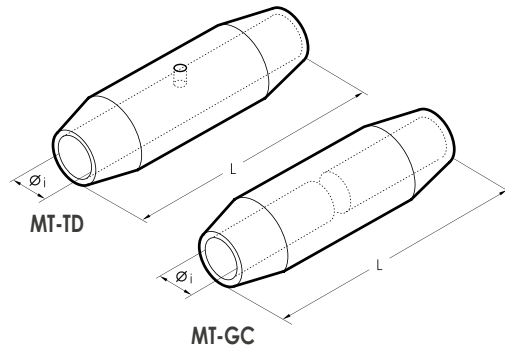

Conductor Size (sqmm) & Format	Type	Type	Dimensions mm		Quantity Box/Bag	Hydraulic Tools			
			ø1	L		HT45-E B450ND-BV	HT51 RH50 B500E B500ND B550	HT81-U RHU81	ECW-H3D RHU520
25 R/BR/BS*	MT25-TD	MT25-GC	6,8	60,0	90/3	HT120 and tools and heads with 130 kN crimping force	ECW-H3D RHU520		
30 RC/S ÷ 40 S	MT40S-TD	MT40S-GC	8,2	60,0	90/3				
30 BR/BS*	MT35-TD	MT35-GC	8,2	60,0	90/3				
50 RC	MT50R-TD	MT50R-GC	8,7	60,0	90/3				
50 S	MT50S-TD	MT50S-GC	9,5	60,0	90/3				
50 BR/BS*	MT50-TD	MT50-GC	9,5	60,0	90/3				
63 S ÷ 70 S	MT70S-TD	MT70S-GC	11,0	70,0	30/3				
70 BR/BS*	MT70-TD	MT70-GC	11,0	70,0	30/3				
80 S ÷ 95 RC	MT95R-TD	MT95R-GC	12,0	80,0	30/3				
95 S ÷ 100 S	MT95S-TD	MT95S-GC	13,5	80,0	30/3				
95 BR/BS*	MT95-TD	MT95-GC	13,5	80,0	30/3				
120 RC/S ÷ 150 RC	MT150R-TD	MT150R-GC	15,0	80,0	30/3				
120 BR/BS*	MT120-TD	MT120-GC	15,0	80,0	30/3				
150 S ÷ 160 RC	MT150S-TD	MT150S-GC	16,5	80,0	30/3				
150 BR/BS*	MT150-TD	MT150-GC	16,5	80,0	30/3				
160 S ÷ 200 RC	MT200R-TD	MT200R-GC	17,0	100,0	30/3				
185 BR/BS*	MT185-TD	MT185-GC	18,0	100,0	30/3				
200 S ÷ 240 RC	MT240R-TD	MT240R-GC	19,2	100,0	21/3				
240 S ÷ 315 RC	MT315R-TD	MT315R-GC	21,5	100,0	21/3				
240 BR/BS*	MT240-TD	MT240-GC	20,5	100,0	30/3				
300 BR/BS*	MT300-TD	MT300-GC	23,0	100,0	30/3				
315 S	MT315S-TD	MT315S-GC	23,7	100,0	21/3				
400 BR/BS*	MT400-TD	MT400-GC	27,0	120,0	15/3				
500 R	MT500-TD		30,3	118,0	12/3				
600 R ÷ 630 R	MT630-TD		33,4	130,0	9/3				

Conductor Format: R = Round, RC = Round Compact, S = Sector, BR = BS EN 60228 Round, BS* = BS EN 60228 size - Sector shaped
* = Pre-rounding required, consult Cembre for appropriate die set



MT-TD and MT-GC series connectors are designed to join conductors in medium voltage applications up to 35 kV.

They are manufactured from Copper with a purity greater than 99.9%, annealed and Tin plated.

MT-GC series feature a solid stop which forms a barrier between the two conductors being joined, this prevents the migration of oils or greases, which may be present, in one cable contaminating the other cable.

MT-TD connectors are unblocked and are suitable for joining cables of the same type.

Details of the appropriate crimping tools and dies are shown on page 264.

AA-M

ALUMINIUM TERMINALS

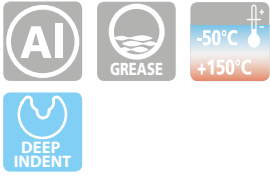
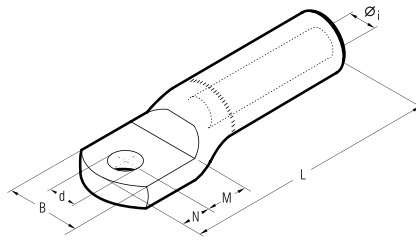

AA-M series terminals are made from Aluminium of a purity equal to or greater than 99,5%. They are designed to accept a variety of conductor forms especially low stranded compacted conductors. Non circular conductors may require pre-rounding prior to introduction to the terminal. Barrels are capped and filled with grease so as to avoid oxidation of the Aluminium. Details of the appropriate crimping tools and dies are shown on page 265, 267.

Conductor Size sqmm	Ø Stud mm	Type	Dimensions mm						Quantity Box/Bag	Hydraulic Tools			
			Øi	B	M	N	L	d					
16	8	AA16-M8	5,5	21	13	11	77,0	8,4	60/3	HT131-UC	RHU131-C	B1300-UC	
25	8	AA25-M8	6,5	21	13	11	77,0	8,4	60/3				
35	8	AA35-M8	8,0	23	13	11	77,5	8,4	60/3				
	10	AA35-M10	8,0	23	13	11	77,5	10,5	60/3				
50	12	AA50-M12	9,0	26	16	14	91,0	13,2	60/3				
	14	AA50-M14	9,0	26	18	16	95,0	15,0	60/3				
70	12	AA70-M12	11,0	27	16	14	91,0	13,2	45/3				
	14	AA70-M14	11,0	27	18	16	95,0	15,0	45/3				
95	12	AA95-M12	12,5	27	16	14	91,0	13,2	45/3				
	14	AA95-M14	12,5	27	18	16	95,0	15,0	45/3				
120	12	AA120-M12	13,7	35	16	14	115,0	13,2	30/3				
	14	AA120-M14	13,7	35	18	16	119,0	15,0	30/3				
150	12	AA150-M12	15,5	34	16	14	115,0	13,2	30/3				
	14	AA150-M14	15,5	34	18	16	119,0	15,0	30/3				
185	12	AA185-M12	17,0	42	20	14	122,0	13,2	18/3				
	14	AA185-M14	17,0	42	22	16	126,0	15,0	18/3				
240	12	AA240-M12	19,5	44	20	14	122,0	13,2	15/3				
	14	AA240-M14	19,5	44	22	16	126,0	15,0	15/3				
300	12	AA300-34M12	22,5	47	22	14	130,0	13,2	15/3				
	14	AA300-34M14	22,5	47	22	16	132,0	15,0	15/3				
	16	AA300-34M16	22,5	47	22	17	133,0	17,0	15/3				
	16	AA300-M16	23,3	54	22	19	177,0	17,0	12/3				
400	16	AA400-M16	26,0	56	19	17	172,0	17,0	15/3				
500	16	AA500-40M16	29,1	57	22	19	177,0	17,0	12/3				
630	16	AA630-M16	32,5	70	22	19	177,0	17,0	9/3				



THROUGH CONNECTORS

for Aluminium conductors

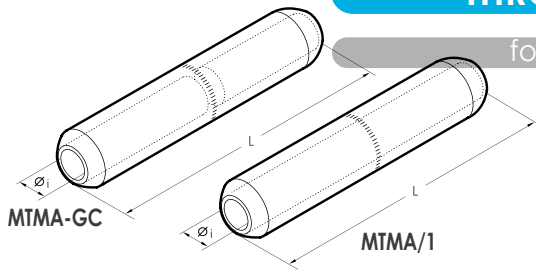

MTMA-GC MTMA/1



Conductor Size sqmm	Type	Type	Dimensions mm		Quantity Box/Bag	Hydraulic Tools	
			øi	L			
10	MTMA10-GC		4,3	90,5	60/3	B1300-UC	
16	MTMA16-GC	MTMA16/1	5,5	90,5	60/3		
25	MTMA25-GC	MTMA25/1	6,5	90,5	60/3		
35	MTMA35-GC	MTMA35/1	8,0	90,5	60/3		
	MTMA35-20-GC		8,0	106,5	30/3		
50	MTMA50-GC	MTMA50/1	9,0	106,5	30/3		
70	MTMA70-GC	MTMA70/1	11,0	106,5	30/3		
95	MTMA95-GC		12,5	110,0	30/3		
		MTMA95/1	12,5	106,5	30/3		
120	MTMA120-GC	MTMA120/1	13,7	133,0	30/3		
150	MTMA150-GC		15,5	135,0	30/3		
		MTMA150/1	15,5	133,5	30/3		
185	MTMA185-GC	MTMA185/1	17,0	143,5	15/3		
240	MTMA240-GC	MTMA240/1	19,5	143,5	15/3		
300	MTMAD300-GC		22,5	144,5	15/3		
		MTMAD300/1	22,5	135,0	15/3		
	MTMA300-GC		23,3	218,0	15/3		
400		MTMA400/1	26,0	218,0	15/3		
500	MTMA500-GC		29,1	218,5	12/3		
630		MTMA500-40/1	29,1	218,0	15/3		
		MTMA630/1	32,5	218,5	12/3		

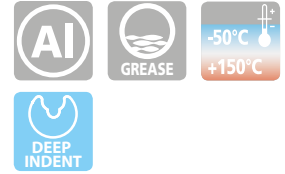

MTMA-GC series through connectors are made from Aluminium of a purity equal to or greater than 99,5%.

They feature a solid stop which creates a barrier between the two sides of conductors to be joined. Barrels are capped and filled with grease so as to avoid oxidation of the connector. MTMA/1 series through connectors are unblocked and are suitable for joining cables of the same type.

Details of the appropriate crimping tools and dies are shown on pages 266-267.

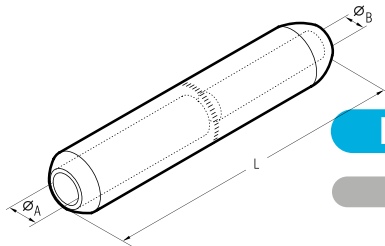

REDUCER THROUGH CONNECTORS

for Aluminium or Copper conductors

MTMA-GC



Conductor Size sqmm	Side A Al	Side B Al/Cu	Type	Dimensions mm			Quantity Box/Bag	Hydraulic Tools	
				øA	øB	L			
16	10		MTMA 16-10-GC	5,5	4,3	90,5	60/3	B1300-UC	
25	10		MTMA 25-10-GC	6,5	4,3	90,5	60/3		
	16		MTMA 25-16-GC	6,5	5,5	90,5	60/3		
50	25		MTMA 50-25-GC	9,0	6,5	106,5	30/3		
	35		MTMA 50-35-GC	9,0	8,0	106,5	30/3		
70	35		MTMA 70-35-GC	11,0	8,0	106,5	30/3		
	50		MTMA 70-50-GC	11,0	9,0	106,5	30/3		
95	50		MTMA 95-50-GC	12,5	9,0	109,4	30/3		
	70		MTMA 95-70-GC	12,5	11,0	106,5	30/3		
120	70		MTMA 120-70-GC	13,7	11,0	133,0	30/3		
	95		MTMA 120-95-GC	13,7	12,5	133,0	30/3		
150	70		MTMA 150-70-GC	15,5	11,0	133,0	30/3		
	95		MTMA 150-95-GC	15,5	12,5	134,4	30/3		
185	120		MTMA 150-120-GC	15,5	13,7	133,0	30/3		
	120		MTMA 185-120-GC	17,0	13,7	143,5	15/3		
240	150		MTMA 185-150-GC	17,0	15,5	143,5	15/3		
	150		MTMA 240-150-GC	19,5	15,5	143,5	15/3		
300	185		MTMA 240-185-GC	19,5	17,0	143,5	15/3		
	95		MTMAD 300-95-GC	22,5	12,5	144,5	15/3		
400	150		MTMAD 300-150-GC	22,5	15,5	144,5	15/3		
	185		MTMAD 300-185-GC	22,5	17,0	144,5	15/3		
	240		MTMAD 300-240-GC	22,5	19,5	144,5	15/3		
500	240		MTMA 400-240-GC	26,0	19,5	218,0	15/3		
	300		MTMA 400-300-GC	26,0	23,3	218,0	15/3		
630	300		MTMA 500-300-GC	29,1	23,3	218,5	12/3		
	400		MTMA 500-400-GC	29,1	26,0	218,5	12/3		



MTMA-GC series reducer through connectors are manufactured to the same specification as MTMA-GC series through connectors. Details of the appropriate crimping tools and dies are shown on pages 266-267.

for non-tension connections on Aluminium conductors according to DIN EN 50182

Tube dimensions according to DIN 46329

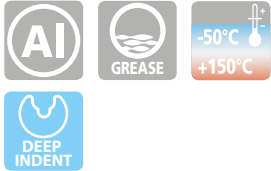
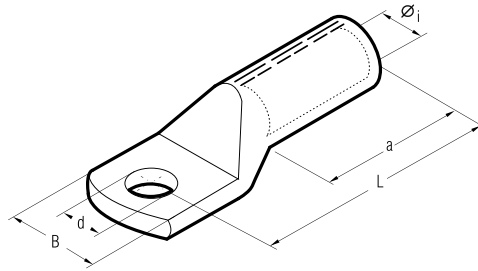

Terminals type AAD.-M.. are made from Aluminium tube of a purity equal or greater than 99,5%. They are suitable for Aluminium conductors according to DIN EN 50182, up to 10 kV.

All terminals are filled with a special grease that avoids Aluminium oxidation after crimping thereby assuring an optimal compression.

Barrel is closed with a cap for storage and transport.

Bright surface finish

The following data is stamped on the terminal:

- Cembre logo
- Terminal description
- Section
- Fixing bolt size
- Number and position of crimps
- Cembre Die reference according to DIN 48083

Details of the appropriate crimping tools and dies are shown on page 271.

Conductor Size	Ø Stud mm	Ref.	Code	Dimensions mm					Quantity Bag	Hydraulic Tools	
				Øi	B	L	d	a			
16 25	8	AAD16-M8	12	5,8	18	52	8,5	32	50	HT45-E B450ND-BV HT45-E B500ND HT 81-U RHU 81 HT 120 and tools and heads with 130 kN crimping force ECW-H3D RHU 450 RHU 520	
	10	AAD16-M10	12	5,8	18	52	10,5	32			50
25 35	8	AAD25-M8	12	6,8	19	60	8,5	37	50		
	10	AAD25-M10	12	6,8	19	60	10,5	37			50
35 50	8	AAD35-M8	14	8,0	21	67	8,5	42	35		
	10	AAD35-M10	14	8,0	21	67	10,5	42			35
	12	AAD35-M12	14	8,0	21	67	13,0	42			
50 70	8	AAD50-M8	16	9,8	25	72	8,5	42	30		
	10	AAD50-M10	16	9,8	25	72	10,5	42			30
	12	AAD50-M12	16	9,8	25	72	13,0	42			
70 95	10	AAD70-M10	18	11,2	28	83	10,5	52	15		
	12	AAD70-M12	18	11,2	28	83	13,0	52			15
	16	AAD70-M16	18	11,2	28	83	17,0	52			
	10	AAD95-M10	22	13,2	32	90	10,5	55			10
95 120	12	AAD95-M12	22	13,2	32	90	13,0	55	10		
	16	AAD95-M16	22	13,2	34	90	17,0	55			10
120 150	10	AAD120-M10	22	14,7	32	91	10,5	55	10		
	12	AAD120-M12	22	14,7	32	91	13,0	55			10
	16	AAD120-M16	22	14,7	34	91	17,0	55			
150 185	10	AAD150-M10	25	16,5	35	104	10,5	60	8		
	12	AAD150-M12	25	16,5	35	104	13,0	60		8	
	16	AAD150-M16	25	16,5	35	104	17,0	60			8
	20	AAD150-M20	25	16,5	41	104	21,0	60		8	
	12	AAD185-M12	28	18,3	40	105	13,0	60			15
185 240	16	AAD185-M16	28	18,3	40	105	17,0	60	15		
	20	AAD185-M20	28	18,3	40	105	21,0	60		15	
240 300	12	AAD240-M12	32	21,0	45	119	13,0	70	12		
	16	AAD240-M16	32	21,0	45	119	17,0	70		12	
	20	AAD240-M20	32	21,0	45	119	21,0	70			12
300	12	AAD300-M12	34	23,3	49	125	13,0	70	9		
	16	AAD300-M16	34	23,3	49	125	17,0	70		9	
	20	AAD300-M20	34	23,3	49	125	21,0	70			9
400	12	AAD400-M12	38	26,0	58	140	13,0	100	3		
	16	AAD400-M16	38	26,0	58	140	17,0	100		3	
	20	AAD400-M20	38	26,0	58	140	21,0	100			3
500	12	AAD500-M12	44	29,0	63	160	13,0	100	3		
	16	AAD500-M16	44	29,0	63	160	17,0	100		3	
	20	AAD500-M20	44	29,0	63	160	21,0	100			3

rm = round stranded
sm = sector stranded
re = round solid
se = sector solid

ALUMINIUM THROUGH CONNECTORS

DSVA

for non-tension connections on Aluminium conductors according to DIN EN 50182

Manufactured according to DIN 46267 Part 2

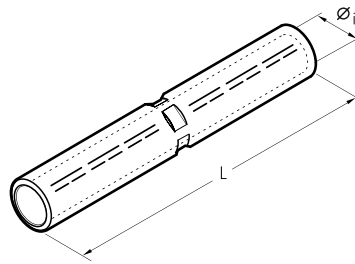

Conductor Size		Code	Ref.	Dimensions mm		Quantity Bag	Hydraulic Tools						
rm sm	re se			øi	L		HT45-E	B450ND-BV	B500ND	RHU 81	ECW-H3D		
16	25	12	DSVA16	5.8	55	30	HT151	RH50	B500	RHU 81	ECW-H3D	RHU 450	RHU 520
25	35	12	DSVA25	6.8	70	25							
35	50	14	DSVA35	8.0	85	25							
50	70	16	DSVA50	9.8	85	20							
70	95	18	DSVA70	11.2	105	20							
95	120	22	DSVA95	13.2	105	15							
120	150	22	DSVA120	14.7	105	15							
150	185	25	DSVA150	16.5	125	10							
185	240	28	DSVA185	18.3	125	10							
240	300	32	DSVA240	21.0	145	5							
300		34	DSVA300	23.3	145	10							
400		38	DSVA400	26.0	210	3							
		42	DSVA401	28.0	210	3							
500		44	DSVA500	29.0	210	3							
		46	DSVA501	31.0	210	3							
600		52	DSVA625	35.0	330	4							
800		58	DSVA800	40.0	350	3							
1000		60	DSVA1000	44.0	350	3							

rm = round stranded
sm = sector stranded
re = round solid
se = sector solid



Crimping through connectors type DSVAs are manufactured according to DIN 46267 part 2.

The aluminum tube has a purity equal to or greater than 99.5%. The crimping through connectors are suitable for aluminum conductors according to DIN EN 50182, up to 10 kV.

All connectors are filled with a special grease that avoids aluminum oxidation after crimp and thus guarantees an optimal compression.

Barrels are capped for storage and transport.

On the connector following information is shown:

- Cembre logo
- Connector description
- Section
- Number and position of crimps
- Compression code according to DIN 48083

Details of the appropriate crimping tools and dies are shown on page 271.

CAA-M

BIMETALLIC CONNECTORS

Copper palm fixing - Aluminium barrels

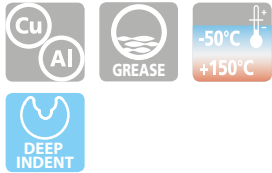
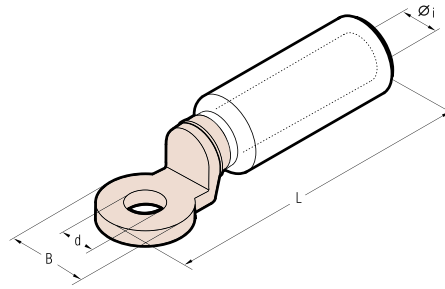

The barrels of series CAA-M connectors are made from Aluminium of a purity equal to or greater than 99.5%.

The barrel is friction welded to the palm thus achieving the best possible transition between the Copper palm and Aluminium barrel. Barrels are capped and filled with grease so as to avoid oxidation of the Aluminium.

Details of the appropriate crimping tools and dies are shown on pages 265, 267.

Conductor Size sqmm	Ø Stud mm	Type	Dimensions mm				Quantity Box/Bag	Hydraulic Tools	
			Øi	B	L	d			
10	12	CAA10-M12	4,3	24,0	87,0	13,0	90/3	B1300-UC	
16	12	CAA16-M12	5,5	24,0	87,0	13,0	90/3		
25	12	CAA25-M12	6,5	24,0	87,0	13,0	90/3		
35	12	CAA35-M12	8,0	24,0	87,0	13,0	90/3		
	12	CAA35-20-M12	8,0	24,0	87,0	13,0	60/3		
50	12	CAA50-M12	9,0	24,0	87,0	13,0	60/3		
70	12	CAA70-M12	11,0	24,0	87,0	13,0	60/3		
95	10	CAA95-M10 NEW	12,5	24,0	87,0	10,5	30/3		
	12	CAA95-M12	12,5	24,0	87,0	13,0	30/3		
120	12	CAA120-M12	13,7	31,0	111,0	13,0	24/3		
150	12	CAA150-M12	15,5	31,0	111,0	13,0	24/3		
185	12	CAA185-M12	17,0	35,0	116,0	13,0	18/3		
	12	CAA240-M12	19,5	35,0	116,0	13,0	18/3		
300	12	CAA300-34-M12	22,5	35,0	120,0	13,0	15/3	HT120 HT131-C RH131	
	16	CAA300-34-M16	22,5	35,0	120,0	17,0	15/3		
400	12	CAA400-M12 NEW	26,0	35,0	152,5	13,0	9/3	ECW-H3D	
	16	CAA400-M16	26,0	35,0	152,5	16,5	9/3		
500	16	CAA500-M16-TNBD	29,1	35,0	152,5	16,5	9/3		
630	8	CAA630-4M8	32,5	60,0	200,0	4 x 9,0*	9/3	RHU230-630	

* 4 holes with 30 mm between axes

MTA-C

BIMETALLIC CONNECTORS

Copper pin - Aluminium barrels

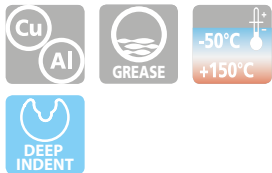
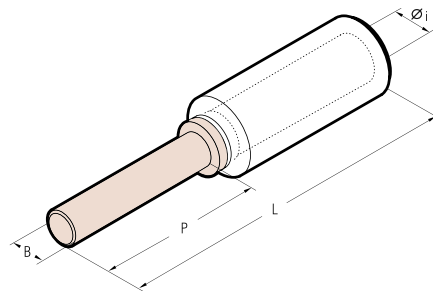

The barrels of series MTA-C connectors are made from Aluminium of a purity equal to or greater than 99.5%.

The barrel is friction welded to the pin thus achieving the best possible transition between the Copper pin and Aluminium barrel.

Barrels are capped and filled with grease so as to avoid oxidation of the Aluminium.

Details of the appropriate crimping tools and dies are shown on pages 265, 267.



Conductor Size sqmm	Type	Dimensions mm				Quantity Box/Bag	Hydraulic Tools
		Øi	B	P	L		
16	MTA16-C	5,5	8	30	82	90/3	HT131-UC RHU131-C B1300-UC
25	MTA25-C	6,5	8	30	82	90/3	
35	MTA35-C	8,0	8	30	82	90/3	
50	MTA50-C	9,0	12	45	97	60/3	
70	MTA70-C	11,0	12	45	97	60/3	
95	MTA95-C	12,5	12	45	97	60/3	
120	MTA120-C	13,7	14	55	125	30/3	
150	MTA150-C	15,5	14	55	125	30/3	
185	MTA185-C	17,0	14	55	125	24/3	
240	MTA240-C	19,5	14	55	125	24/3	

MECHANICAL LUGS

MLA-C

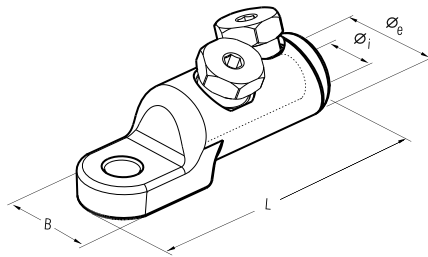
For Low and Medium voltage Al/Cu conductors



Conductor Size sqmm	Type	Ø Stud mm	Dimensions mm				N° of Bolts	Number of centring devices	Quantity Box/Bag
			Øe	Øi	B	L			
50-240	MLA50-240-12C	12	33	20,5	33	106,5*	2	3   	1/10

* without centring devices



Cembre range-taking mechanical connectors are intended for use with Copper and Aluminium conductors, for low and medium voltage (up to 52kV) installations, in indoor, outdoor and underground applications.

Mechanical connector bodies (pic.1) are made from Aluminium EN-AW 2011 T6 with cross sectional

area and barrel length designed to optimise electrical connectivity. Internal surfaces are protected against oxidation by grease with a very high dropping point, while the Tin plating on external surfaces has a minimum thickness of 12 µm for improved surface protection.

Shear bolts (pic.2) are made from the same material and designed

to ensure a reliable electrical connection simply by tightening the bolts with a standard socket until shearing occurs inside the threaded hole without external protrusion.

To minimise voltage stresses, connectors are provided with centring devices (pic.3) to improve the alignment of the different conductor



sizes.

Key features:

- Wide range of conductor cross sections
- Suitable for Copper and Aluminium conductors
- Tested according to IEC 61238
- Torque controlled to guarantee a good electrical contact
- Reduces inventory levels
- Easy installation - only requires a standard socket
- Reduced installation time

Pic. 1



Conductor Size sqmm	Centring device	
	Color	Type
50 - 70 - 95	Red	
120 - 150	Blue	
185	Yellow	
240	Not required	

Pic. 3

ML-C

MECHANICAL LUGS WITH SYMMETRICAL PALM

For Medium voltage Al/Cu conductors

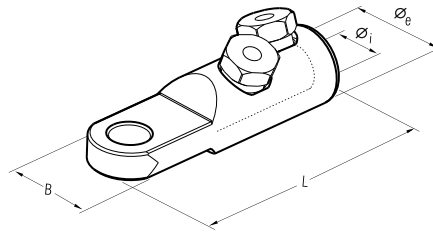

Conductor Size sqmm	Type	Ø Stud mm	Dimensions mm				N° of Bolts	Number of centring devices	Quantity Box/Bag
			Øe	Øi	B	L			
95-240	ML95-240-12C	12	35	20,5	35	124*	2	3 ● ● ●	1/10
95-240	ML95-240-16C	16	35	20,5	35	124*	2	3 ● ● ●	1/10
150-240	ML150-240-12C	12	35	20,5	35	124*	2	2 ● ●	1/10
150-240	ML150-240-16C	16	35	20,5	35	124*	2	2 ● ●	1/10

* without centring devices

MBS-C

MECHANICAL SPLICES

For Low and Medium voltage Al/Cu conductors

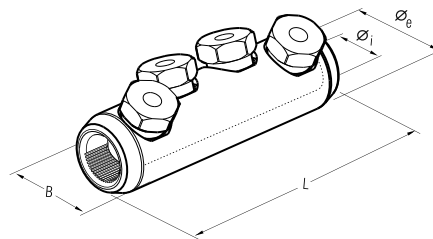

Conductor Size sqmm	Type	Dimensions mm				N° of Bolts	Number of centring devices	Quantity Box/Bag
		Øe	Øi	B	L			
50-240	MBS50-240-C	35	20,5	35	124*	4	3 ● ● ●	1/20
95-240	MBS95-240-C	35	20,5	35	124*	4	3 ● ● ●	1/20

* without centring devices

TERMINAL BLOCKS, FLEXIBLE BUSBAR, BRAIDS AND DISTRIBUTION BLOCKS



symbol description

terminal blocks



Polycarbonate body



Zinc plated Steel screws



Polyamide PA6.6 body



Chrome plated Steel screws



Polypropylene body



Brass clamp



Steatite body



Operating temperature range



Polyvinylchloride insulating sheath



Italian Institute of the Quality Mark type approval



Electrolytically Tin plated Copper interconnections



Lloyd's Register Marine type approval



Electrolytically Tin plated to avoid oxidation



Italian Naval Register type approval



Nominal voltage V



USR-CNR type approval valid for USA and CANADA



Degree of Protection IP20



CE marking



Self-extinguishing class V0 UL94



UKCA marking

example applications

terminal blocks

type
ZETApiù®

Z35T-11 uninterrupted,
main earth loop, terminal block.
Used for equipotential bonding



UNINTERRUPTED
MAIN EARTH
LOOP



Z6-10D terminal blocks
used in a control panel.

SUITABLE
FOR DIN RAIL
MOUNTING



Z16-8D and Z6-6D
mounted on DIN rails.
Used in control panels

type
ZETAmini®

ZETAmini terminal blocks
used for domestic/commercial
applications.



type
ZETAblock®

A typical application of the
Z50-DP12-160 and Z35-DP14B-125
installed in a distribution panel



Z6

SINGLE POLE TERMINAL BLOCKS

indirect clamping - nominal section 6 sqmm



type
ZETApiù®

The "Z...D" version has been designed for mounting on DIN rails

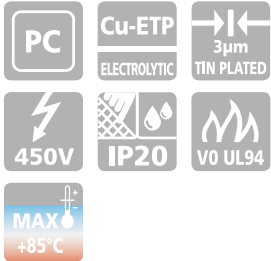

Connecting Capacity sqmm	Type	No. of Ways	Nominal Voltage V	Maximum Operating Temperature °C	Insulation Specification	Self Extinguishing Specification	Dimensions mm	Weight g	Quantity
(3 way) 1÷6	Z6-3	3	450	85	IP20	V-0 (UL 94)	23x23xh27,5	15,0	30
	Z6-3D						23x40xh36,5	18,5	10
(5 way) 1÷6	Z6-5	5	450	85	IP20	V-0 (UL 94)	35x23xh27,5	23,0	20
	Z6-5D						35x40xh36,5	26,5	10
(6 way) 1÷6	Z6-6	6	450	85	IP20	V-0 (UL 94)	23x43xh28,5	26,0	15
	Z6-6D						23x53xh33	31,0	10
(10 way) 1÷6	Z6-10	10	450	85	IP20	V-0 (UL 94)	35x43xh28,5	41,0	10
	Z6-10D						35x53xh33	46,0	15

D= Version with clamp for DIN rail

3, 5, 6 and 10 way, single pole terminal blocks for conductor section 1 to 6 sqmm.

Self contained and robust, they are quick and easy to install for both industrial and domestic use. The indirect clamping of the "ZETApiù" terminal blocks guarantees a low and stable contact resistance.

Indirect clamping eliminates damage to the conductor strands.

The easy-entry receptacles also grant a fast and reliable insertion of the cable.

Technical features:

- Self-extinguishing Polycarbonate body
- Tempered Steel clamps
- Electrolytically Tin plated Copper interconnections

Z16

SINGLE POLE TERMINAL BLOCKS

indirect clamping - nominal section 16 sqmm



type
ZETApiù®

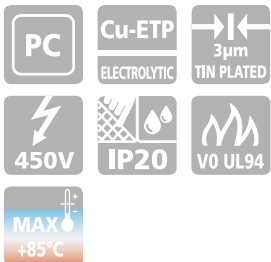

Connecting Capacity sqmm	Type	No. of Ways	Nominal Voltage V	Maximum Operating Temperature °C	Insulation Specification	Self Extinguishing Specification	Dimensions mm	Weight g	Quantity
16	Z16-3	3	450	85	IP20	V-0 (UL 94)	38x31,3xh38	52,0	20
	Z16-3D						38x50xh44	55,5	15
16	Z16-4	4	450	85	IP20	V-0 (UL 94)	27x54xh37	50,0	15
	Z16-4D						27x58xh43	54,0	10
16	Z16-5N	5	450	85	IP20	V-0 (UL 94)	61x31,5xh38	64,5	10
	Z16-5ND						61x50xh44	68,0	4
(2 way) 16 + (6 way) 6	Z16-8	8 (2÷6)	450	85	IP20	V-0 (UL 94)	35,5x50xh36,5	50,0	15
	Z16-8D						35,5x57xh42	56,0	10
(2 way) 16 + (10 way) 6	Z16-12	12 (2÷10)	450	85	IP20	V-0 (UL 94)	104,5x32,5xh36,5	115,0	8
	Z16-12D						104,5x50xh42	125,0	5

D= Version with clamp for DIN rail

3, 4, 5, 8 and 12 way, single pole terminal blocks.

Ideal for use as an equipotential bonding connector for both industrial and domestic use.

SINGLE POLE TERMINAL BLOCKS

indirect clamping - nominal section 35 sqmm

type
ZETApiù®

Z35-3



Z35-4



Z35-6



Connecting Capacity sqmm	Type	No. of Ways	Nominal Voltage V	Maximum Operating Temperature °C	Insulation Specification	Self Extinguishing Specification	Dimensions mm	Weight g	Quantity
35	Z35-3	3	450	85	IP20	V-0 (UL 94)	53x48,5xh42	110	10
	Z35-3D						53x50xh48	114	5
35	Z35-4	4	450	85	IP20	V-0 (UL 94)	37x85xh42	129	5
	Z35-4D						37x85xh48	133	5
(2 way) 35 + (4 way) 16	Z35-6	6 (2÷4)	450	85	IP20	V-0 (UL 94)	83x41xh43	130	8
	Z35-6D						83x49xh52	140	5

D= Version with clamp for DIN rail

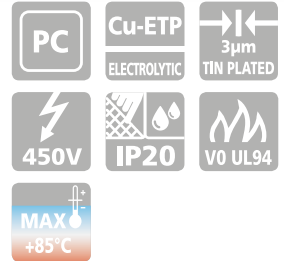

3, 4 and 6 way, single pole terminal blocks. Ideal for use as an equipotential bonding connector for both industrial and domestic use.

SINGLE POLE TERMINAL BLOCKS

indirect clamping - for earthing applications ⊕

type
ZETApiù®

Z50-10D



Z35T-11
Z35T-11D



Z35-26D



Connecting Capacity sqmm	Type	No. of Ways	Maximum Operating Temperature °C	Self Extinguishing Specification	Dimensions mm	Weight g	Quantity
(1 way) 35 + (10 way) 6	Z35T-11	11	85	V-0 (UL 94)	58x43xh42	70	10
	Z35T-11D	(1+10)			58x53xh47	75	10
(2 way) 35 + (24 way) 10	Z35-26D	26 (2+24)	85	V-0 (UL 94)	151x52xh48	379	4
(2 way) 50 + (8 way) 25	Z50-10D	10 (2+8)	85	V-0 (UL 94)	77,5x55xh49	320	6

D= Version with clamp for DIN rail

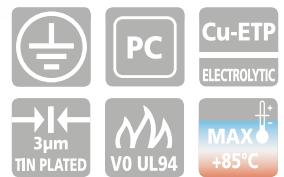



























10, 11 and 26 way, single pole terminal blocks. Ideal for use as an equipotential bonding connector for both industrial and domestic use.

CONNECTING CAPACITY OF TERMINAL BLOCKS

indirect clamping

type
ZETApiù®

Type	Nominal Section	No. of Ways x Nominal Section	Connecting Capacity of Each Way* No. of Conductors x Section	Markings
Z6-3 Z6-3D	6□	3 x 6□		   6 mm ² 450 V T 85°C  
Z6-5 Z6-5D	6□	5 x 6□	1 x 6□ R/F 1 x 4□ R/F	
Z6-6 Z6-6D	6□	6 x 6□	1÷2 x 2,5□ R/F 1÷2 x 1,5□ R/F 1÷4 x 1□ R/F	   6 mm ² 450 V T 85°C 
Z6-10 Z6-10D	6□	10 x 6□		
Z16-3 Z16-3D	16□	3 x 16□	1 x 16□ R/F 1 x 10□ R/F 1÷2 x 6□ R/F 1÷3 x 4□ R/F 1÷4 x 2,5□ R/F 1÷8 x 1,5□ R/F	   16 mm ² 450 V T 85°C  
Z16-4 Z16-4D	16□	4 x 16□	1 x 16□ F 1 x 10□ F 1÷2 x 6□ F 1÷3 x 4□ F 1÷4 x 2,5□ F 1÷8 x 1,5□ F	
Z16-5N Z16-5ND	16□	5 x 16□	1 x 16□ R/F 1 x 10□ R/F 1÷2 x 6□ R/F 1÷3 x 4□ R/F 1÷4 x 2,5□ R/F 1÷8 x 1,5□ R/F	   16 mm ² 450 V T 85°C 
Z16-8 Z16-8D	16□ / 6□	2 x 16□	1 x 16□ R/F 1 x 10□ R/F 1÷2 x 6□ R/F 1÷3 x 4□ R/F 1÷4 x 2,5□ R/F 1÷8 x 1,5□ R/F	
		6 x 6□	1 x 6□ R/F 1 x 4□ R/F 1÷2 x 2,5□ R/F 1÷2 x 1,5□ R/F 1÷4 x 1□ R/F	   16~6 mm ² 450 V T 85°C 
Z16-12	16□ / 6□	2 x 16□	1 x 16□ F 1 x 10□ F 1÷2 x 6□ F 1÷3 x 4□ F 1÷4 x 2,5□ F	
Z16-12D	16□ / 6□	10 x 6□	1 x 6□ F 1 x 4□ F 1÷2 x 2,5□ F 1÷2 x 1,5□ F 1÷4 x 1□ F	   16~6 mm ² 450 V T 85°C 

* A mixture of conductor sizes may be connected to the terminal block provided that the sum of their sections is less than the nominal section.
R = Rigid conductor F = Flexible conductor

CONNECTING CAPACITY OF TERMINAL BLOCKS

indirect clamping

type
ZETApìù®

Type	Nominal Section	No. of Ways x Nominal Section	Connecting Capacity of Each Way* No. of Conductors x Section	Markings
Z35-3 Z35-3D	35□	3 x 35□	1 x 35□ R/F 1 x 25□ R/F 1÷2 x 16□ R/F 1÷3 x 10□ R/F 1÷5 x 6□ R/F	CE UK CA 35 mm ² 450 V T 85°C
Z35-4 Z35-4D	35□	4 x 35□	1 x 35□ F 1 x 25□ F 1÷2 x 16□ F 1÷3 x 10□ F 1÷6 x 6□ F	CE UK CA 35 mm ² 450 V T 85°C
Z35-6 Z35-6D	35□ / 16□	2 x 35□	1 x 35□ R/F 1 x 25□ R/F 1÷2 x 16□ R/F 1÷3 x 10□ R/F 1÷6 x 6□ F	CE UK CA 35~16 mm ² 450 V T 85°C
		4 x 16□	1 x 16□ R/F 1 x 10□ R/F 1÷2 x 6□ R/F 1÷3 x 4□ R/F 1÷5 x 2,5□ F	
Z35T-11 Z35T-11D	35□ / 6□	1 x 35□	1 x 35□ R/F 1 x 25□ R/F 1 x 16□ R/F 1 x 10□ R/F	CE UK CA 35~6 mm ² T 85°C
		10 x 6□	1 x 6□ R/F 1 x 4□ R/F 1÷2 x 2,5□ R/F 1÷2 x 1,5□ R/F 1÷4 x 1□ R/F	
Z35-26D	35□ / 10□	2 x 35□	1 x 35□ R/F 1 x 25□ R/F 1÷2 x 16□ R/F 1÷3 x 10□ R/F 1÷6 x 6□ R/F	CE UK CA 35~10 mm ² T 85°C
		24 x 10□	1 x 10□ R/F 1 x 6□ R/F 1÷2 x 4□ R/F 1÷4 x 2,5□ R/F	
Z50-10D	50□ / 25□	2 x 50□	1 x 50□ R/F 1 x 35□ R/F 1÷2 x 25□ R/F 1÷4 x 16□ R/F	CE UK CA ** 50~25 mm ² T 85°C
		8 x 25□	1 x 25□ R/F 1÷2 x 16□ R/F 1÷3 x 10□ R/F 1÷6 x 6□ R/F 1÷9 x 4□ R/F	

* A mixture of conductor sizes may be connected to the terminal block provided that the sum of their sections is less than the nominal section.
R = Rigid conductor F = Flexible conductor

MARKINGS



Italian Institute of the Quality Mark
type approval



Lloyd's Register Marine
type approval



Italian Naval Register
type approval



**
EN60947-1: 2007+A1: 2011: 2014
and EN 60947-7-1: 2002 Norms



Conforms to:

Directive 2014/35/UE

EN 60998-1: 2004 and
EN 60998-2-1: 2004 Norms

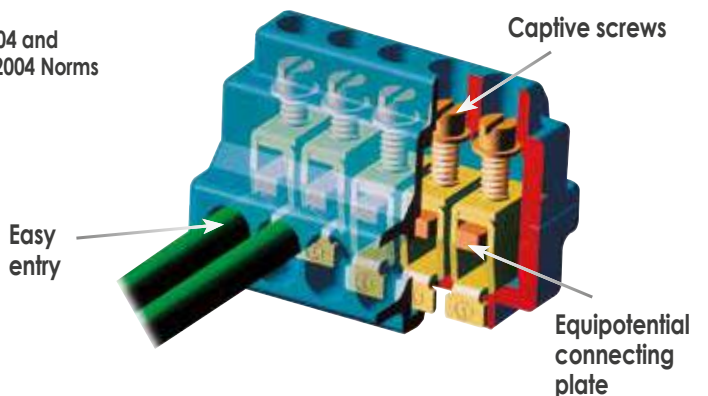



Type	No. of poles	No. of Ways per pole	Nominal CSA for each pole sqmm	Maximum operating voltage (Ui)	Impulse voltage (Uimp)	Maximum operating current (In)	Allowable short duration fault current (Icw)	Maximum allowed peak fault current (Ipk)	Self Extinguishing Specification	Dimensions mm	Weight g	Qty
Z25-DP7-100	4	7 (2+5)	(2 way) 25 + (5 way) 6	800 V	8 kV	100 A	3 kA	18 kA	V-0 (UL 94)	70x84xh45	290	2
Z35-DP14-125	4	14 (2+2+10)	(2 way) 35 + (2 way) 16 + (10 way) 6	800 V	8 kV	125 A	4,2 kA	18 kA	V-0 (UL 94)	137x83xh46	700	1
Z35-DP14B-125	2	14 (2+2+10)	(2 way) 35 + (2 way) 16 + (10 way) 6	800 V	8 kV	125 A	4,2 kA	18 kA	V-0 (UL 94)	137x44xh46	360	2
Z50-DP12-160	4	12 (2+4+6)	(2 way) 50 + (4 way) 25 + (6 way) 16	800 V	8 kV	160 A	6 kA	18 kA	V-0 (UL 94)	150x84xh48	780	1

100, 125 and 160A, 2-4 pole distribution blocks with 7, 14 and 12 ways per pole respectively. Accepting a wide cable CSA range (1 - 50 sqmm) and of compact size, Zetablocks are ideal for control cabinets and distribution panels. The lateral arrangement of terminals on upper and lower faces (Z35-DP14B one face only), simplifies connection and promotes tidy, homogeneous cable routing to assist subsequent wiring operations. Easy entry apertures provide quick, effective cable insertion while the indirect clamping feature eliminates damage to cable strands and assures a low, stable contact resistance.

Technical features:

- Self extinguishing antishock Polycarbonate body
- Tempered Steel captive clamping screws and plates
- Electrolytically Tin plated Copper interconnectors

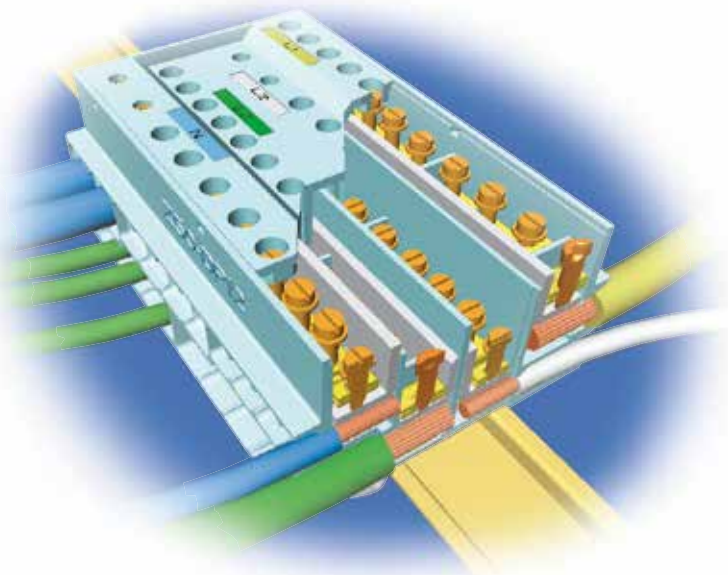

POWER DISTRIBUTION BLOCK

Z-DP

indirect clamping





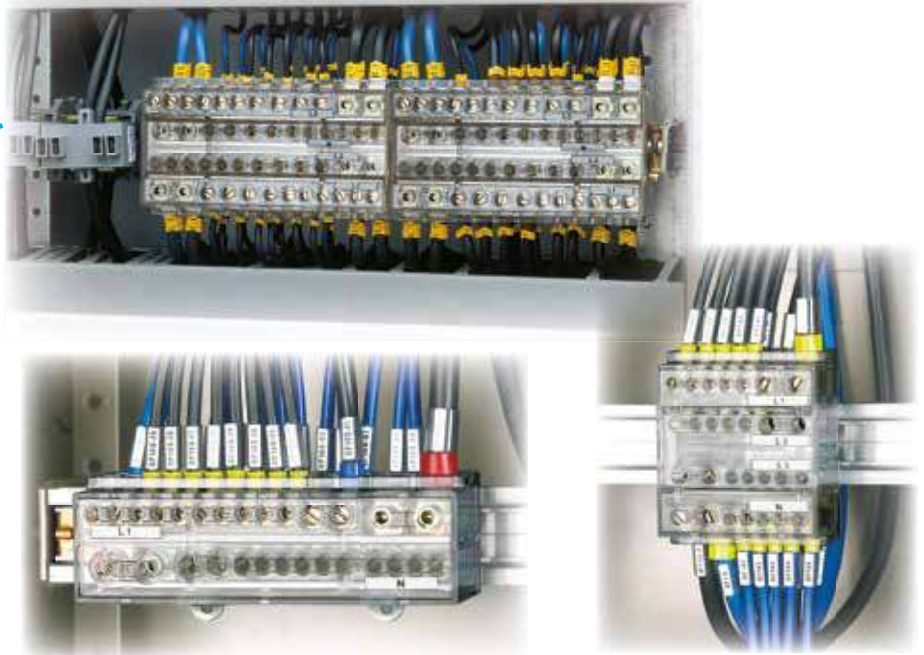



type

ZETAblock®



CONNECTING CAPACITY OF POWER DISTRIBUTION BLOCK

indirect clamping

Type	Nominal Section	No. of Ways x Nominal Section	Connecting Capacity of Each Way No. of Conductors x Section	Markings
Z25-DP7-100	25□/6□	2 x 25□	1 x 25□ F 1 x 16□ F 1÷2 x 10□ F	   25÷6 sqmm
		5 x 6□	1 x 6□ F 1 x 4□ F 1÷2 x 2,5□ F 1÷2 x 1,5□ F 1÷4 x 1□ F	
Z35-DP14-125	35□/16□/6□	2 x 35□	1 x 35□ F 1 x 25□ F 1÷2 x 16□ F 1÷3 x 10□ F	   35÷16÷6 sqmm
		2 x 16□	1 x 16□ F 1 x 10□ F 1÷2 x 6□ F 1÷3 x 4□ F 1÷4 x 2,5□ F	
Z35-DP14B-125		10 x 6□	1 x 6□ F 1 x 4□ F 1÷2 x 2,5□ F 1÷2 x 1,5□ F 1÷4 x 1□ F	
Z50-DP12-160	50□/25□/16□	2 x 50□	1 x 50□ F 1 x 35□ F 1÷2 x 25□ F	   50÷25÷16 sqmm
		4 x 25□	1 x 25□ F 1 x 16□ F 1÷2 x 10□ F	
		6 x 16□	1 x 16□ F 1 x 10□ F 1÷2 x 6□ F	

F = Flexible conductor

MARKINGS



Italian Institute of the Quality Mark
type approval

Conforms to:
Directive 2014/35/UE

EN 60947-7-1: 2009 Norms

indirect clamping

type
ZETAmini®



Connecting Capacity sqmm	Type	Nominal Voltage V	Maximum Operating Temperature °C	Insulation Specification	Self Extinguishing Specification	Dimensions mm	Weight g	Quantity
2,5	Z2.5-1	450	85	IP20	V-0 (UL 94)	7,6x20xh23,5	3	500/25
6	Z6-1	450	85	IP20	V-0 (UL 94)	11,5x28xh29	6	250/25
10	Z10-1	450	85	IP20	V-0 (UL 94)	15,6x32xh32,5	11	80/10
16	Z16-1	450	85	IP20	V-0 (UL 94)	18x34xh38	15	60/10
25	Z25-1	450	85	IP20	V-0 (UL 94)	20,8x42,5xh43,5	29	50/10
35	Z35-1	450	85	IP20	V-0 (UL 94)	25x45xh51,5	37	40/10

One way, single pole terminal blocks for conductors sections from 0.5 to 35 sqmm.

Self contained and robust, they are ideal for the fast and safe installation for industrial and domestic applications.

The indirect clamping of the "ZETAmini" terminal blocks guarantees a low and stable contact resistance.

The easy-entry receptacle also grants a fast and reliable insertion of the cable.

Technical features:

- Self-extinguishing Polycarbonate body
- Electrolytically Zinc plated, tempered Steel clamp and screw
- Electrolytically Tin plated Steel connection plate

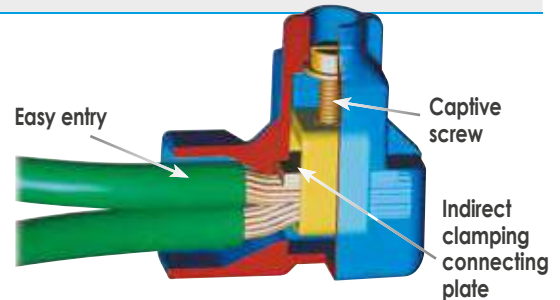

Type	Nominal Section	Connecting Capacity of Each Way* No. of Conductors x Section	Markings
Z2.5-1	2,5□	2 x 2,5□ R/F 2÷3 x 1,5□ R/F 2÷5 x 1,0□ R/F 2÷6 x 0,75□ R/F 2÷10 x 0,5□ R/F 2÷18 x Ø 0,4÷0,6 mm communication type wire	CE UK CA IP20 2,5 sqmm 450V T 85°C IP 20 APPROVED R
Z6-1	6□	2 x 6□ R/F 2÷3 x 4□ R/F 2÷4 x 2,5□ R/F 2÷6 x 1,5□ R/F 2÷6 x 1□ R/F 2÷10 x 0,75□ R/F 2÷12 x 0,5□ R/F (1 x 6□ F) + (4 x 1,5□ F) (1 x 6□ F) + (2 x 2,5□ F)	CE UK CA IP20 6 sqmm 450V T 85°C IP 20 APPROVED R
Z10-1	10□	2 x 10□ R/F 2÷3 x 6□ R/F 2÷5 x 4□ R/F 2÷8 x 2,5□ R/F 2÷12 x 1,5□ R/F 2÷20 x 1□ R/F 2÷25 x 0,75□ R/F (1 x 6□ F) + (1 x 4□ F) + (2 x 2,5□ F) + (3 x 1,5□ F)	CE UK CA IP20 10 sqmm 450V T 85°C IP 20 APPROVED R
Z16-1	16□	2 x 16□ R/F 2÷3 x 10□ R/F 2÷5 x 6□ R/F 2÷8 x 4□ R/F 2÷12 x 2,5□ R/F 2÷18 x 1,5□ R/F	CE UK CA IP20 16 sqmm 450V T 85°C IP 20 APPROVED R
Z25-1	25□	2 x 25□ R/F 2÷3 x 16□ R/F 2÷4 x 10□ R/F 2÷8 x 6□ R/F 2÷11 x 4□ R/F 4÷16 x 2,5□ R/F	CE UK CA IP20 25 sqmm 450V T 85°C IP 20 APPROVED R
Z35-1	35□	2 x 35□ R/F 2÷3 x 25□ R/F 2÷4 x 16□ R/F 2÷7 x 10□ R/F 2÷11 x 6□ R/F 4÷17 x 4□ R/F 5÷28 x 2,5□ R/F	CE UK CA IP20 35 sqmm 450V T 85°C IP 20 APPROVED R

*A mixture of conductor sizes may be connected to the terminal block provided that the sum of their sections is less than twice the nominal section.

R = Rigid conductor F = Flexible conductor

Conforms to:

Directive 2014/35/UE

EN 60998-1: 2004 and
EN 60998-2-1: 2004 Norms

TERMINAL BLOCK TYPE EKL

EKL

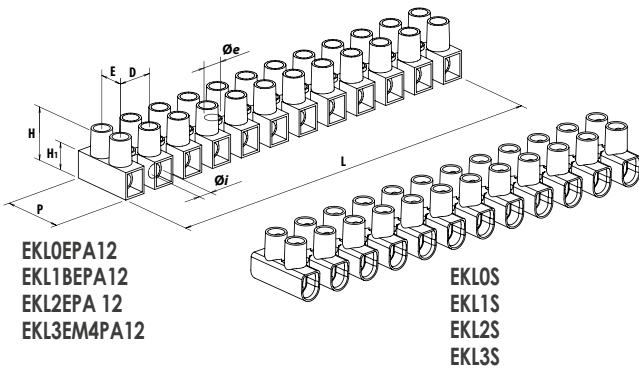

EKLOEPA12
EKL1BEPA12
EKL2EPA12
EKL3EM4PA12

EKLOS
EKL1S
EKL2S
EKL3S

EKL4BEPA12
EKL4BESVCE



Type 12 Poles of Polyamide (PA6.6)

Type	Nominal section sqmm	Dimensions mm								Screw	Quantity
		Øi	Øe	L 12 poles	H	H1	P	E	D		
△ EKLOEPA12	2,5	2,8	2,8	93,6	13,4	7,6	16,2	6,4	8,0	M2,6	50
△ EKL1BEPA12	4	3,5	3,6	117,0	15,0	8,0	18,6	7,3	10,0	M3	30
△ EKL2EPA12	10	4,2	3,7	132,7	17,3	8,8	22,2	10,0	11,5	M3,5	15
□ EKL3EM4PA12	16	5,8	5,2	175,0	20,8	11,4	25,2	11,0	15,0	M4	25
○ EKL4BEPA12	25	7,0	4,0	187,3	28,0	15,5	30,0	11,0	16,0	M5	25

Type 12 Poles of Polypropylene (PP)

Type	Nominal section sqmm	Dimensions mm								Screw	Quantity
		Øi	Øe	L 12 poles	H	H1	P	E	D		
● EKLOS	4	3,2	2,65	94,9	13,0	-	16,6	6,4	8,1	M2,6	50
● EKL1S	6	3,5	3,4	116,5	14,9	-	18,9	7,3	10,0	M3	30
● EKL2S	10	4,3	3,7	133,8	17,3	-	23,4	10,0	11,5	M3,5	15
● EKL3S	16	5,5	4,9	174,5	25,0	-	20,7	11,0	15,0	M4	25
◇ EKL4BESVCE	25	7,0	4,0	187,3	28,0	-	30,0	11,0	16,0	M5	25



- △ Nominal voltage : 450 V
Ambient temperature : max 85°C
- Nominal voltage : 450 V
Ambient temperature: max 110°C

- Nominal voltage: 750 V
Ambient temperature: max 110°C
- Nominal voltage: 450 V
Ambient temperature: max 80°C
- ◇ Nominal voltage: 750 V
Ambient temperature: max 80°C

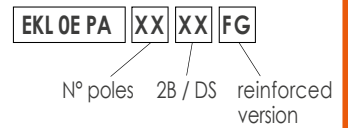
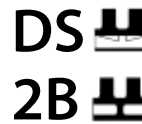

TERMINAL BLOCK TYPE ZS

ZS

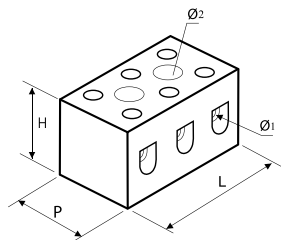

Type	Nominal section sqmm		No. of poles	Dimensions mm					Quantity
	Low Str.	Flex		Ø1	Ø2	L	H	P	
ZS-U6	4/6	4	1	2,8	-	9	18	19	200
ZS-B6	4/6	4	2	2,8	4,0	22	18	19	80
ZS-T6	4/6	4	3	2,8	4,0	36	18	19	60
ZS-U10	10	6	1	4,3	-	13	20	21	200
ZS-B10	10	6	2	4,3	4,8	24	20	21	80
ZS-T10	10	6	3	4,3	4,8	36	20	21	70
ZS-U16	16	10	1	6,1	-	15	22	27	100
ZS-B16	16	10	2	6,1	5,0	31	22	27	50
ZS-T16	16	10	3	6,1	5,0	48	22	27	30



- Material:**
- insulating body in STEATITE
 - screw in GALVANIZED STEEL
 - BRASS clamp

Nominal voltage: 450 V
Operating temperature: 350°C

DB/1N



UNIPOLAR DISTRIBUTION BLOCKS

direct clamping

DBLOCK UNIPOLAR SERIES

- 80, 125, 160, 250, 400, 500 A distribution blocks
- Versions available with 6, 7 or 11 outputs (see table)
- Wire entry facilitated by chamfered entry holes and clamping screws

- Terminals maintain excellent stability of the connection over time

Neutral bar expansions available for types DB125-14/4 and DB160-11/4



Type	N° inputs	Connecting Capacity in mm²	N° outputs	Connecting Capacity out mm²	IEC* 60947-7-1		UL* 1059		Allowable short duration fault current (Icw)	Maximum allowed peak fault current (Ipk)	Self Extinguishing Specification	Dimensions mm	Weight g	Qty
					Nominal voltage	Nominal Current	Nominal voltage	Nominal Current						
DB80-6/1N	1	6÷16	6 (4+2)	(4) 2,5÷6 (2) 2,5÷16	1000 V	80 A	600 V	85 A	3 kA	22 kA	V-0 (UL 94)	66x27xh46	70	5
DB125-7/1N	1	10÷35	7 (6+1)	(6) 2,5÷16 (1) 6÷16	1000 V	125 A	600 V	150 A	4.2 kA	30 kA	V-0 (UL 94)	77x29xh46	142	5
DB160-7/1N	1	10÷70	7 (6+1)	(6) 2,5÷16 (1) 6÷16	1000 V	160 A	600 V	200 A	11.8 kA	30 kA	V-0 (UL 94)	77x29xh46	136	5
DB250-11/1N	1	35÷120	11 (2+5+4)	(2) 6÷35 (5) 2,5÷16 (4) 2,5÷10	1000 V	250 A	600 V	255 A	24.5 kA	51 kA	V-0 (UL 94)	96x46xh50	423	3
DB400-11/1N	1	95÷185	11 (2+5+4)	(2) 6÷35 (5) 2,5÷16 (4) 2,5÷10	1000 V	400 A	600 V	335 A	24.5 kA	51 kA	V-0 (UL 94)	96x46xh50	402	3
DB500-11/1N	1	8x24 Flex. Busbar	11 (2+5+4)	(2) 6÷35 (5) 2,5÷16 (4) 2,5÷10	1000 V	500 A	600 V	335 A	24.5 kA	51 kA	V-0 (UL 94)	96x46xh50	388	3

DB/2

BIPOLAR DISTRIBUTION BLOCKS

direct clamping



DBLOCK BIPOLAR SERIES

- 40, 100, 125 A bipolar distribution blocks
- Versions available with 6, 13, 14 or 15 outputs (see table)

- Wire entry facilitated by chamfered entry holes
- Terminals maintain excellent stability of the connection over time



Type	N° inputs	Connecting Capacity in mm²	N° outputs	Connecting Capacity out mm²	Nominal voltage	Nominal Current	Allowable short duration fault current (Icw)	Maximum allowed peak fault current (Ipk)	Self Extinguishing Specification	Dimensions mm	Weight g	Quantity
DB100-6/2	1	10÷25	6 (3+3)	(3) 1,5÷4 / 0,75÷4 (3) 2,5÷6 / 1,5÷6	500 V	100 A	4.5 kA	20 kA	V-0 (UL 94)	50x64xh50	110	1
DB100-13/2	2	10÷25	13 (6+7)	(6) 1,5÷4 / 0,75÷4 (7) 2,5÷6 / 1,5÷6	500 V	100 A	4.5 kA	20 kA	V-0 (UL 94)	50x130xh50	208	1
NEW DB125-6/2	1	10÷35	6 (5+1)	(5) 2,5÷6 / 1,5÷6 (1) 10÷25 / 6÷16	690 V	125 A	4.5 kA	18 kA	V-0 (UL 94)	50x94xh50	160	1
DB125-14/2	1	10÷35	14 (11+3)	(11) 2,5÷6 / 1,5÷6 (3) 10÷25 / 6÷16	690 V	125 A	4.5 kA	18 kA	V-0 (UL 94)	50x162xh50	266	1
NEW DB125-14/2C	2	10÷35 10÷16	13 (11+2)	(11) 2,5÷6 / 1,5÷6 (2) 10÷25 / 6÷16	500 V	125 A	4.5 kA	20 kA	V-0 (UL 94)	50x130xh50	204	1

TETRAPOLAR DISTRIBUTION BLOCKS

DB/4

direct clamping



DBLOCK TETRAPOLAR

- 40, 100, 125, 160 A distribution blocks
- Versions available with 6, 13, 14 or 15 outputs (see table)
- Wire entry facilitated by chamfered entry holes
- Terminals maintain excellent stability of the connection over time

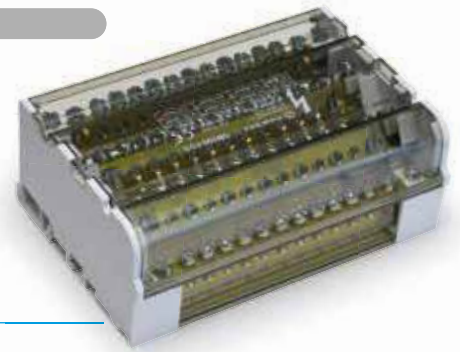

Type	N° inputs	Connecting Capacity in mm²	N° outputs	Connecting Capacity out mm²	Nominal voltage	Nominal Current	Allowable short duration fault current (Icw)	Maximum allowed peak fault current (Ipk)	Self Extinguishing Specification	Dimensions mm	Weight g	Quantity
DB40-11/4	2	6÷16 4÷10	11	1,5÷4 / 0,75÷4	500 V	40 A	4.5 kA	22 kA	V-0 (UL 94)	90x100xh50	351	1
DB100-6/4	1	10÷25	6 (3+3)	(3) 1,5÷4 / 0,75÷4 (3) 2,5÷6 / 1,5÷6	500 V	100 A	4.5 kA	20 kA	V-0 (UL 94)	90x64xh50	230	1
DB100-13/4	2	10÷25	13 (6+7)	(6) 1,5÷4 / 0,75÷4 (7) 2,5÷6 / 1,5÷6	500 V	100 A	4.5 kA	20 kA	V-0 (UL 94)	90x130xh50	444	1
DB125-6/4	1	10÷35	6 (5+1)	(5) 2,5÷6 / 1,5÷6 (1) 10÷25 / 6÷16	690 V	125 A	4.5 kA	20 kA	V-0 (UL 94)	90x109xh50	326	1
NEW DB125-10/4	1	10÷35	10 (7+3)	(7) 2,5÷6 / 1,5÷6 (3) 10÷25 / 6÷16	690 V	125 A	4.5 kA	20 kA	V-0 (UL 94)	90x147xh50	440	1
NEW DB125-10/4C	2	10÷35 10÷16	9 (7+2)	(7) 2,5÷6 / 1,5÷6 (2) 10÷25 / 6÷16	500 V	125 A	4.5 kA	20 kA	V-0 (UL 94)	90x100xh50	306	1
DB125-14/4	1	10÷35	14 (11+1+2)	(11) 2,5÷6 / 1,5÷6 (1) 10÷25 / 6÷16 (2) 10÷35 / 10÷25	690 V	125 A	4.2 kA	14.5 kA	V-0 (UL 94)	90x182xh50	586	1
NEW DB125-14/4C	2	10÷35 10÷16	13 (11+2)	(11) 2,5÷6 / 1,5÷6 (2) 10÷25 / 6÷16	500 V	125 A	4.5 kA	20 kA	V-0 (UL 94)	90x130xh50	398	1
DB160-11/4	1	10÷50	11 (3+7+1)	(3) 10÷35 / 10÷25 (7) 2,5÷6 / 1,5÷6 (1) 2,5÷6 / 1,5÷6	690 V	160 A	8.2 kA	35 kA	V-0 (UL 94)	96x175xh50	738	1



ACCESSORIES

neutral bars



Type	N° inputs	Connecting Capacity in mm²	N° outputs	Connecting Capacity out mm²	Nominal voltage	Nominal Current	Allowable short duration fault current (Icw)	Maximum allowed peak fault current (Ipk)	Type Application	Length mm	Weight g	Quantity
DNB125-9	4	10÷25 / 6÷16	9	2,5÷6 / 1,5÷6	-	125 A	4.5 kA	30 kA	DB125-10/4 DB125-14/4	142	172	1
DNB160-10	4	10÷35 / 10÷25	10	2,5÷16 / 1,5÷16	-	160 A	6.2 kA	35 kA	DB160-11/4	168	192	1



unipolar jumper



Type	Nominal Current	Type Application	Length mm	Weight g	Quantity
DJ160	125 A - 160 A	DB125-7/1 - DB160-7/1	37	29	5



DJ160



Designation

SFI	8	x 24	x 1
Insulated flexible busbar	Number of strips	Strip width mm	Strip thickness mm

Advantages

Insulated flexible busbar is a self-contained system combining convenient layout and connection with assured insulation and self-supporting construction, resulting in reduced cost installations with extreme ease of use.

Compared to plain busbar:

- Higher current capacity size for size
- Space saving as individual insulated busbars may be positioned in closer proximity
- Layout easier and quicker due to flexibility
- Insulated support not required.

Compared to cables:

- Simple and rapid installation
- Space saving due to tighter bend radius
- Insulated support not required.

Principle of selection

The following charts allow selection of the appropriate configuration based on:

- ambient temperature of 35°C
- required current carrying capacity in Amps
- maximum permitted temperature increase

Example of selection

Required current carrying capacity per phase is 630A. Maximum permitted temperature in the equipment enclosure is 85°C:

- ambient temperature is 35°C
- maximum permitted temperature rise is 85°C - 35°C = 50°C

The possible selections are where the red vertical line (630A) intersects the green temperature band (50°C):

SFI8X24X1
SFI6X32X1
SFI4X40X1

The final selection will depend on limitations relating to connection palm width.

Technical features

PVC Insulation (for width 9 - 50mm):

- Colour: Black
- Density: 1,36 g/cm³
- Hardness: 86 Shore A
- Breaking resistance: ≈ 18 MPa
- Breaking elongation: ≈ 300 %
- Self-extinguishing class: Vo (UL94)

Strip:

- Copper designation: Cu-ETP
- Copper purity min: 99,9%
- Max electrical resistivity at 20°C: 1,7241 μΩ/cm (100% IACS)
- Breaking resistance min: 200MPa
- Breaking elongation min: 30%
- Hardness: <55 HV
- Surface protection: Sm 99
- Thickness of tin plating: 2 ÷ 4 μm

Insulated flexible busbar:

- max working voltage: 1000 V AC /1500 V DC
- Working temperature: -40°C ÷ +105°C
- Average thickness of extruded PVC: 2mm
- Average dielectric strength between conductor and earth: 15 kV/mm (50Hz)
- between conductors: 30 kV/mm (50Hz)

Total conductor c.s.a. sqmm	Type
21,6	SFI3X9X0.8
43,2	SFI6X9X0.8
13,0	SFI2X13X0.5
19,5	SFI3X13X0.5
26	SFI4X13X0.5
39	SFI6X13X0.5
37,2	SFI3X15.5X0.8
49,6	SFI4X15.5X0.8
74,4	SFI6X15.5X0.8
124	SFI10X15.5X0.8
40	SFI2X20X1
60	SFI3X20X1
80	SFI4X20X1
100	SFI5X20X1
120	SFI6X20X1
48	SFI2X24X1
72	SFI3X24X1
96	SFI4X24X1
120	SFI5X24X1
144	SFI6X24X1
192	SFI8X24X1
240	SFI10X24X1
64	SFI2X32X1
96	SFI3X32X1
128	SFI4X32X1
160	SFI5X32X1
192	SFI6X32X1
256	SFI8X32X1
320	SFI10X32X1
160	SFI4X40X1
200	SFI5X40X1
240	SFI6X40X1
320	SFI8X40X1
400	SFI10X40X1
200	SFI4X50X1
250	SFI5X50X1
300	SFI6X50X1
400	SFI8X50X1
500	SFI10X50X1
315	SFI5X63X1
378	SFI6X63X1
504	SFI8X63X1
630	SFI10X63X1
320	SFI4X80X1
400	SFI5X80X1
480	SFI6X80X1
640	SFI8X80X1
800	SFI10X80X1
500	SFI5X100X1
800	SFI8X100X1
1000	SFI10X100X1
1200	SFI12X100X1



Concept and design

Cembre SFI series insulated flexible busbar comprises a set of Cu strips within an insulated sleeve - for widths 9-50mm this is extruded PVC, for widths 63-100mm it is heat shrunk material.

The dielectric strength of the insulation is guaranteed independent of the eventual formation of the busbar and its working conditions (humidity, temperature and environmental aggressors).

Dimensions

Standard length: 2000 mm (consult us for other lengths)
Strip thickness: 0,5 - 1 mm
Number of strips: 2 - 12.

Applications

- Power distribution, substituting cable with extruded insulation and rigid busbar
- Electrical equipment (racks, circuit breakers, rectifiers)
- Transformers

Current carrying capacity (A)

Temperature increase for each configuration based on an ambient temperature of 35°C

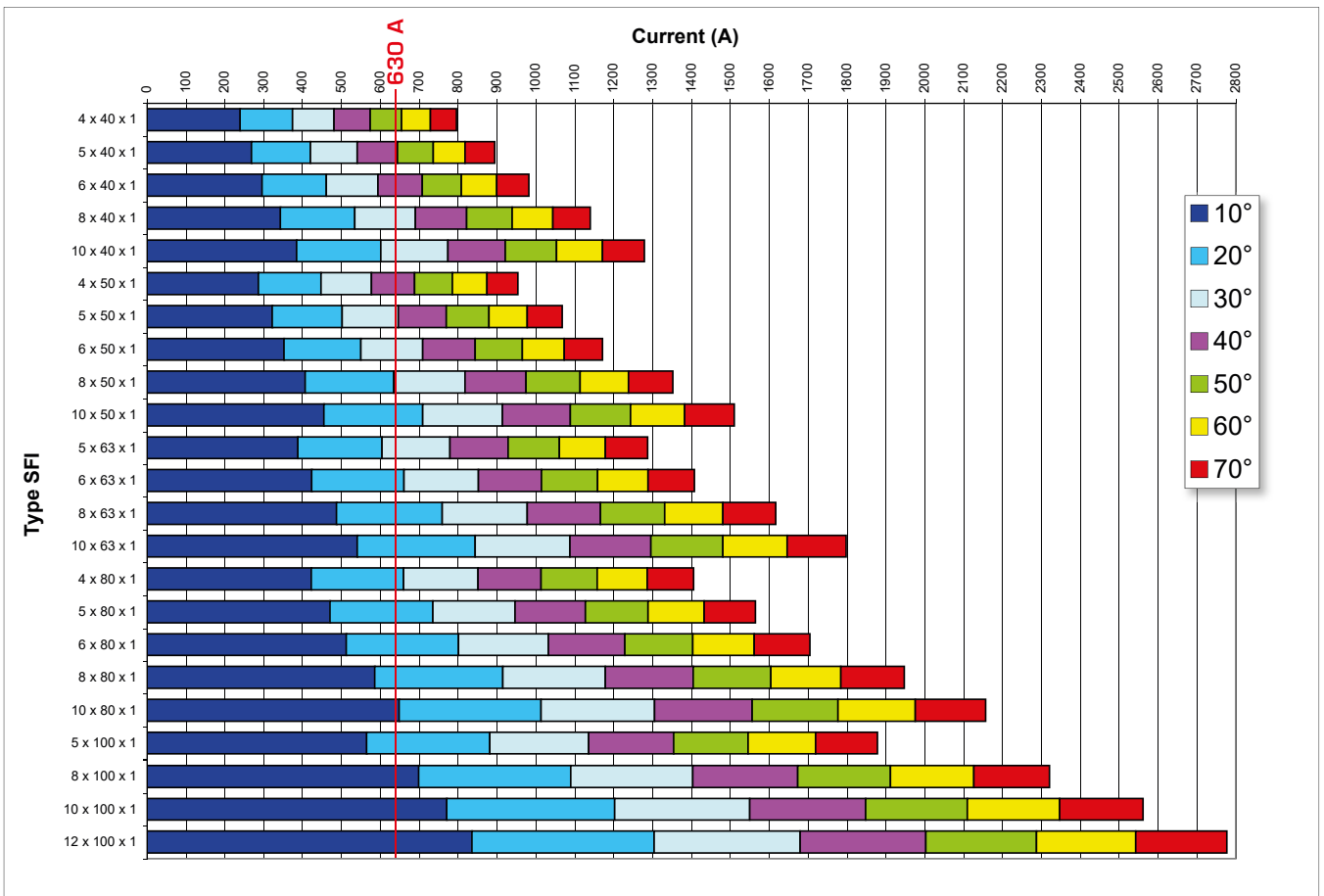
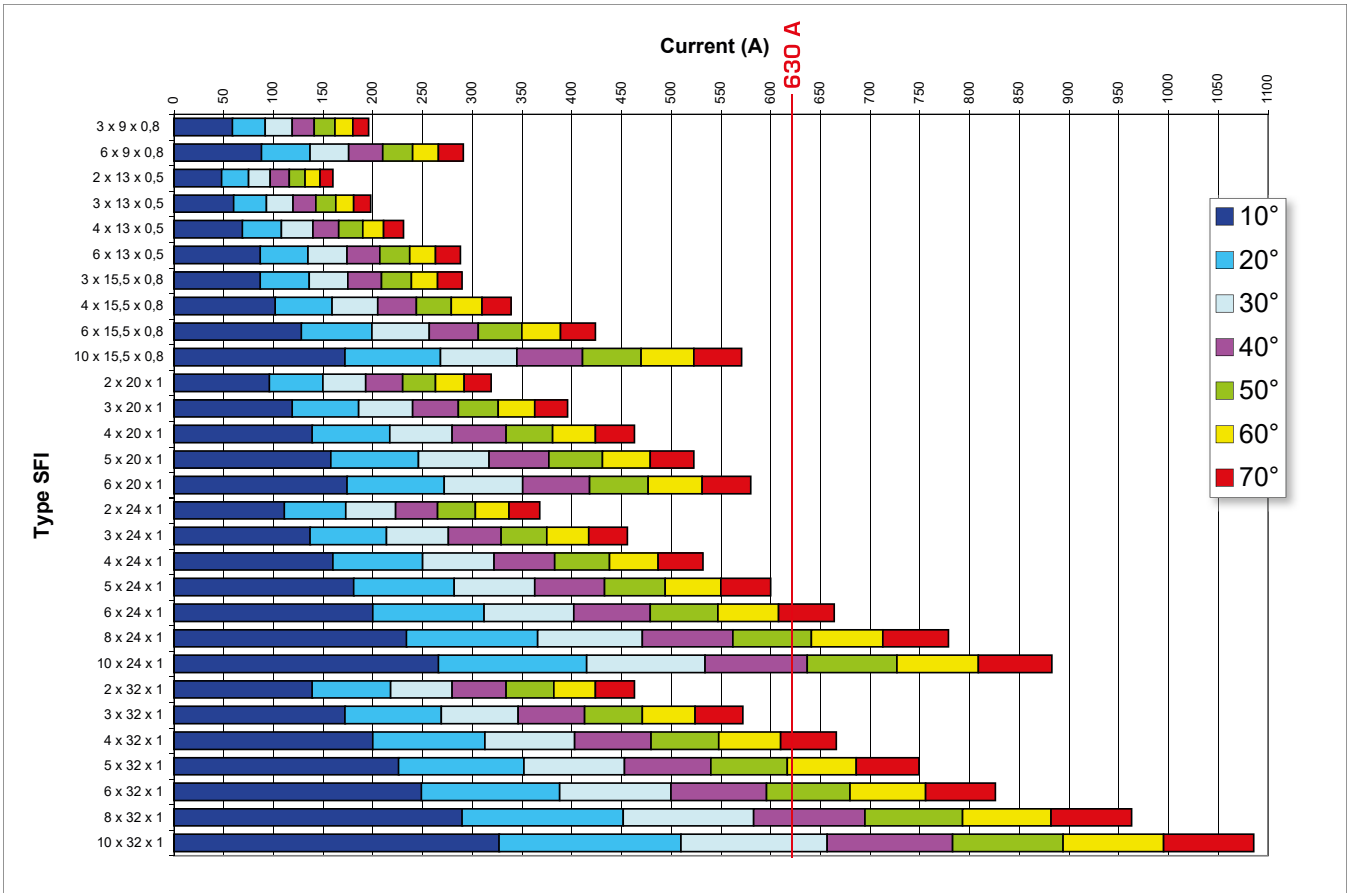

Mechanical bending and torsion testing

Test temperatures: -10°C and +80° C.

Bending 180°

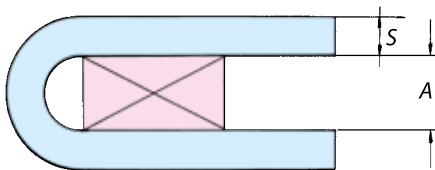

S = Bar thickness (conductor + insulation)
A = 2 x S

Torsion 90°

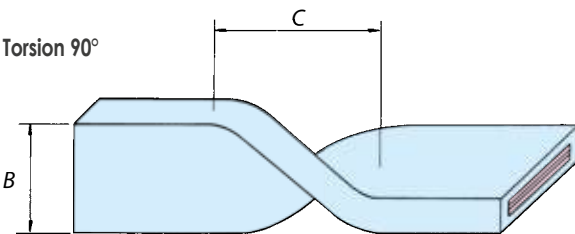

B = Bar width (conductor + insulation)
C = 1,5 x B

In both cases the tests do not show damage to the insulation



Insulated flexible busbar installation

Bending:

Small section configurations may be bent manually. When tooling is used, protect the insulated sleeve of the busbar from damage. As the Cu strips move relative to each other during bending, this operation should be completed before drilling.

Drilling:

Drilling templates type **MFB 13-40** and type **MFB 50-63** (available as optional extras) are designed to facilitate accurate location of fixing holes in the busbar of Ø 8, 10, 12 mm. It is recommended that the insulation of the busbar is not removed before drilling is completed, as it assists the operation.

Template type	includes drilling inserts	for bar width mm
MFB 13-40	SFB13-16	for bar width 13÷15,5 mm
	SFB20-24	for bar width 20÷24 mm
	SFB32-40	for bar width 32÷40 mm
MFB 50-63	SFB50-63	for bar width 50÷63 mm



Flexible braids are manufactured from electrolytic Copper wire. Braids of different conductor sizes or lengths are available on request. Standard finish - bright Copper. Flexible braids can be supplied Tin plated, in this case add the suffix "ST" to reference.

E.g.:
- FL10-150 (Bright Copper)
- FL10-150-ST (Tin plated)

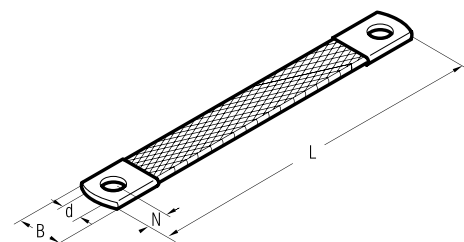













Size sqmm	Ø Stud mm	Type	Dimensions mm				Quantity
			B	N	L	d	
10	8	FL10-150	17	10	150	8,5	50
	8	FL10-200	17	10	200	8,5	50
	8	FL10-250	17	10	250	8,5	50
	8	FL16-150	17	10	150	8,5	50
	8	FL16-200	17	10	200	8,5	50
	8	FL16-250	17	10	250	8,5	50
16	8	FL16-320	17	10	320	8,5	50
	8	FL16-350	17	10	350	8,5	50
	8	FL16-420	17	10	420	8,5	25
	8	FL16-570	17	10	570	8,5	25
	8	FL16-660	17	10	660	8,5	25
	8	FL25-150	21	10	150	8,5	50
25	8	FL25-200	21	10	200	8,5	50
	8	FL25-250	21	10	250	8,5	50
	8	FL25-300	21	10	300	8,5	50

CABLE GLANDS AND ACCESSORIES



symbol description

cable glands and accessories

PA 6.6	Polyamide PA6.6 body		V2 UL94 self-extinguishing class
PA 6	Polyamide PA6 body		VDE marking
NEOPRENE	Neoprene material		ATEX marking
PS	Polystyrene body		USL-CNL Marking valid in USA & CANADA
BRASS	Brass body		USR-CNR Marking valid in USA & CANADA
	Protected by Nickel plated to avoid oxidation		CE Marking
STAINLESS STEEL	Stainless steel body		UKCA marking
STEEL ZINC PLATED	Galvanized Steel body		Meets the requirements for fire testing of materials and components for trains EN 45545-2:2015
NBR	Nitrile-butadiene material		Halogen Free
PVC	Polyvinylchloride material		
EPDM	EPDM rubber material		
ABS	ABS material		
	Operating temperature range		
	Degree of protection		



range overview

cable glands and accessories

MAXIblock®



POLYAMIDE CABLE GLANDS
WITH PROTECTION IP 68

spiralblock®



POLYAMIDE CABLE GLANDS
WITH PROTECTION IP 68

MAXIbrass®



NICKEL PLATED BRASS CABLE GLANDS
WITH PROTECTION IP 68

MAXIinox



STAINLESS STEEL CABLE GLANDS
WITH PROTECTION IP 68



Material: POLYAMIDE PA6.6
 self-extinguishing class V2 (UL 94)
 Temperature range:
 -20°C to +90°C (continuous)
 Sealing ring: NEOPRENE®
 Protection: IP 68
 Colour: RAL 7035 light grey,
 RAL 9005 black, RAL 7001 dark grey

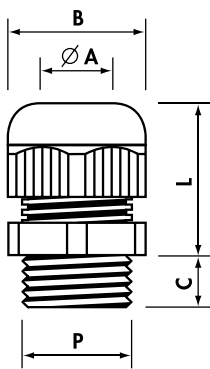

standard

Metric thread M 1.5 pitch CEI EN 60423 CEI EN 62444

Type Light Grey	P	Fixing Hole Ø (mm)	Ø A min-max (mm)	B Spanner (mm)	C (mm)	L min-max (mm)	Quantity
1900.M12	M12x1,5	12,2	3,5- 7	15	8	18-22	100
1900.M16	M16x1,5	16,2	5 -10	19	8	22-27	100
1900.M20	M20x1,5	20,5	7 -13	25	9	24-30	100
1900.M25	M25x1,5	25,4	10 -17	30	10	28-39	50
1900.M32	M32x1,5	32,5	13 -21	36	10	33-44	25
1900.M40	M40x1,5	40,5	19 -28	46	10	36-45	15
1900.M50	M50x1,5	50,5	27 -35	55	12	43-52	10
1900.M63	M63x1,5	64,0	34 -45	66	12	45-55	5

Add to Ref: N for Black, G for Dark Grey

reduced cable entry

Metric thread M 1.5 pitch CEI EN 60423 CEI EN 62444

Type Light Grey	P	Fixing Hole Ø (mm)	Ø A min-max (mm)	B Spanner (mm)	C (mm)	L min-max (mm)	Quantity
1910.M12	M12x1,5	12,2	2- 5	15	8	18-22	100
1910.M16	M16x1,5	16,2	3- 7	19	8	22-27	100
1910.M20	M20x1,5	20,5	5-10	25	9	24-30	100
1910.M25	M25x1,5	25,4	7-13	30	10	28-39	50
1910.M32	M32x1,5	32,5	8-14	36	10	33-44	25
1910.M40	M40x1,5	40,5	15-23	46	10	36-45	15
1910.M50	M50x1,5	50,5	20-29	55	12	43-52	10
1910.M63	M63x1,5	64,0	27-39	66	12	45-55	5

Add to Ref: N for Black, G for Dark Grey

extended thread

Metric thread M 1.5 pitch CEI EN 60423 CEI EN 62444

Type Light Grey	P	Fixing Hole Ø (mm)	Ø A min-max (mm)	B Spanner (mm)	C (mm)	L min-max (mm)	Quantity
1901.M12	M12x1,5	12,2	3,5- 7	15	15	18-22	100
1901.M16	M16x1,5	16,2	5 -10	19	15	22-27	100
1901.M20	M20x1,5	20,5	7 -13	25	15	24-30	50
1901.M25	M25x1,5	25,4	10 -17	30	15	30-41	50
1901.M32	M32x1,5	32,5	13 -21	36	15	33-44	25
1901.M40	M40x1,5	40,5	19 -28	46	18	36-45	15
1901.M50	M50x1,5	50,5	27 -35	55	18	43-52	10
1901.M63	M63x1,5	64,0	34 -45	66	18	45-55	5

Add to Ref: N for Black, G for Dark Grey

MAXIBLOCK CABLE GLANDS

Polyamide PA6.6

1900

MAXIblock®

standard

Pg thread DIN 40 430

Type Light Grey	P	Fixing Hole Ø (mm)	Ø A min-max (mm)	B Spanner (mm)	C (mm)	L min-max (mm)	Quantity
1900.07	Pg 7	12,7	3,5- 7	15	8	18-22	100
1900.09	Pg 9	15,5	5 - 8	19	8	22-26	100
1900.11	Pg11	18,8	5 -10	22	8	23-28	100
1900.13	Pg13,5	20,5	7 -12	24	9	24-29	100
1900.16	Pg16	22,6	10 -14	27	10	26-31	50
1900.21	Pg21	28,5	13 -18	33	12	30-35	50
1900.29	Pg29	37,2	18 -25	42	12	33-39	25
1900.36	Pg36	47,2	20 -32	53	14	42-49	10
1900.42	Pg42	54,2	28 -38	60	14	42-50	5
1900.48	Pg48	60,0	37 -45	66	15	45-55	5

Add to Ref: N for Black, G for Dark Grey

reduced cable entry

Pg thread DIN 40 430

Type Light Grey	P	Fixing Hole Ø (mm)	Ø A min-max (mm)	B Spanner (mm)	C (mm)	L min-max (mm)	Quantity
1910.07	Pg 7	12,7	2- 5	15	8	18-22	100
1910.09*	Pg 9	15,5	2- 6	19	8	22-26	100
1910.11	Pg11	18,8	4- 7	22	8	23-28	100
1910.13	Pg13,5	20,5	5-10	24	9	24-29	100
1910.16*	Pg16	22,6	6-12	27	10	26-31	50
1910.21	Pg21	28,5	9-15	33	12	30-35	50
1910.29*	Pg29	37,2	12-20	42	12	33-39	25
1910.36	Pg36	47,2	18-26	53	14	42-49	10
1910.42	Pg42	54,2	25-31	60	14	42-50	5
1910.48*	Pg48	60,0	27-39	66	15	45-55	5

Add to Ref: N for Black

extended thread

Pg thread DIN 40 430

Type Light Grey	P	Fixing Hole Ø (mm)	Ø A min-max (mm)	B Spanner (mm)	C (mm)	L min-max (mm)	Quantity
1901.07	Pg 7	12,7	3,5- 7	15	15	18-22	100
1901.09	Pg 9	15,5	5 - 8	19	15	22-26	100
1901.11	Pg11	18,8	5 -10	22	15	23-28	100
1901.13	Pg13,5	20,5	7 -12	24	15	24-29	100
1901.16	Pg16	22,6	10 -14	27	15	26-31	50
1901.21	Pg21	28,5	13 -18	33	15	30-35	50
1901.29	Pg29	37,2	18 -25	42	15	33-39	25
1901.36	Pg36	47,2	20 -32	53	18	42-49	10
1901.42	Pg42	54,2	28 -38	60	18	42-50	5
1901.48	Pg48	60,0	37 -45	66	18	45-55	5

Add to Ref: N for Black

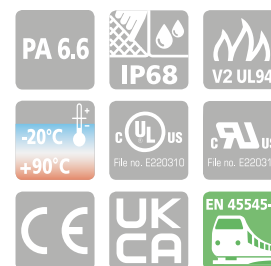

Material: POLYAMIDE PA6.6
self-extinguishing class V2 (UL 94)
Temperature range:
-20°C to +90°C (continuous)
Sealing ring: NEOPRENE®
Protection: IP 68
Colour: RAL 7035 light grey,
RAL 9005 black, RAL 7001 dark grey

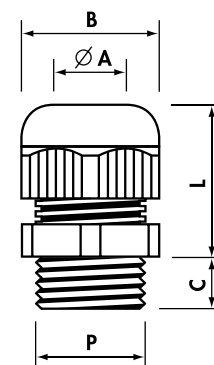

1900/X

MAXIBLOCK CABLE GLANDS

Polyamide PA6.6

MAXIblock[®]



Material: POLYAMIDE PA6.6
self-extinguishing class V2 (UL 94)
Temperature range:
-20°C to +90°C (continuous)
Sealing ring: NEOPRENE®
Protection: IP 68
Colour: RAL 7035 light grey

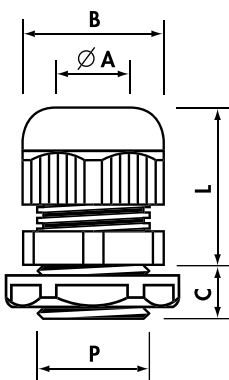
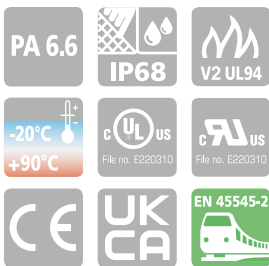

standard, factory fitted with locknuts with collar

Metric thread M 1.5 pitch CEI EN 60423 CEI EN 62444

Type	P	Fixing Hole Ø (mm)	Ø A min-max (mm)	B Spanner (mm)	C (mm)	L min-max (mm)	Quantity Box/Bag
1900.M12/X	M12x1,5	12,2	3,5- 7	15	8	18-22	100/10
1900.M16/X	M16x1,5	16,2	5 -10	19	8	22-27	50/10
1900.M20/X	M20x1,5	20,5	7 -13	25	9	24-30	50/10
1900.M25/X	M25x1,5	25,4	10 -17	30	10	28-39	30/10
1900.M32/X	M32x1,5	32,5	13 -21	36	10	33-44	20/10
1900.M40/X	M40x1,5	40,5	19 -28	46	10	36-45	10/5
1900.M50/X	M50x1,5	50,5	27 -35	55	12	43-52	5/5
1900.M63/X	M63x1,5	64,0	34 -45	66	12	45-55	5/5

standard, factory fitted with locknuts with collar

Pg thread DIN 40 430

Type	P	Fixing Hole Ø (mm)	Ø A min-max (mm)	B Spanner (mm)	C (mm)	L min-max (mm)	Quantity Box/Bag
1900.07/X	Pg 7	12,7	3,5- 7	15	8	18-22	100/10
1900.09/X	Pg 9	15,5	5 - 8	19	8	22-26	100/10
1900.11/X	Pg11	18,8	5 -10	22	8	23-28	50/10
1900.13/X	Pg13,5	20,5	7 -12	24	9	24-29	50/10
1900.16/X	Pg16	22,6	10 -14	27	10	26-31	30/10
1900.21/X	Pg21	28,5	13 -18	33	12	30-35	20/10
1900.29/X	Pg29	37,2	18 -25	42	12	33-39	20/10
1900.36/X	Pg36	47,2	20 -32	53	14	42-49	10/5
1900.42/X	Pg42	54,2	28 -38	60	14	42-50	5/5
1900.48/X	Pg48	60,0	37 -45	66	15	45-55	5/5

MAXIBLOCK CABLE GLANDS

Polyamide PA6.6

MAXIblock®

standard, factory fitted with Polyethylene foam dustproof discs

Metric thread M 1.5 pitch CEI EN 60423 CEI EN 62444

Type	P	Fixing Hole Ø (mm)	Ø A min-max (mm)	B Spanner (mm)	C (mm)	L min-max (mm)	Quantity
1900DP.M12	M12x1,5	12,2	3,5- 7	15	8	18-22	100
1900DP.M16	M16x1,5	16,2	5 -10	19	8	22-27	100
1900DP.M20	M20x1,5	20,5	7 -13	25	9	24-30	100
1900DP.M25	M25x1,5	25,4	10 -17	30	10	28-39	50
1900DP.M32	M32x1,5	32,5	13 -21	36	10	33-44	25
1900DP.M40	M40x1,5	40,5	19 -28	46	10	36-45	15
1900DP.M50	M50x1,5	50,5	27 -35	55	12	43-52	10
1900DP.M63	M63x1,5	64,0	34 -45	66	12	45-55	5

Pg thread DIN 40 430

Type	P	Fixing Hole Ø (mm)	Ø A min-max (mm)	B Spanner (mm)	C (mm)	L min-max (mm)	Quantity
1900DP.07	Pg 7	12,7	3,5- 7	15	8	18-22	100
1900DP.09	Pg 9	15,5	5 - 8	19	8	22-26	100
1900DP.11	Pg11	18,8	5 -10	22	8	23-28	100
1900DP.13	Pg13,5	20,5	7 -12	24	9	24-29	100
1900DP.16	Pg16	22,6	10 -14	27	10	26-31	50
1900DP.21	Pg21	28,5	13 -18	33	12	30-35	50
1900DP.29	Pg29	37,2	18 -25	42	12	33-39	25
1900DP.36	Pg36	47,2	20 -32	53	14	42-49	10
1900DP.42	Pg42	54,2	28 -38	60	14	42-50	5
1900DP.48	Pg48	60,0	37 -45	66	15	45-55	5

MAXIBLOCK CABLE GLANDS

Polyamide PA6.6

BSP thread ISO 228/1

Type Light Grey	P	Fixing Hole Ø (mm)	Ø A min-max (mm)	B Spanner (mm)	C (mm)	L min-max (mm)	Quantity
1900.14	G1/4"	13,5	3- 6,5	15	8	18-22	100
1900.38	G3/8"	17,0	4- 8	19	8	22-26	100
1900.12	G1/2"	21,5	7-12	24	10	24-29	100
1900.34	G3/4"	27,0	13-18	33	12	30-35	50

Add to Ref: N for Black

Material: POLYAMIDE PA6.6
self-extinguishing class V2 (UL 94)
Temperature range:
-20°C to +90°C (continuous)
Sealing ring: NEOPRENE®
Protection: IP 68
Colour: RAL 7035 light grey,
RAL 9005 black

1900DP



Material: POLYAMIDE PA6.6
self-extinguishing class V2 (UL 94)
Temperature range:
-20°C to +90°C (continuous)
Sealing ring: NEOPRENE®
Protection: IP 68
Colour: RAL 7035 light grey
Dustproof discs: 2 mm thick
Polyethylene foam

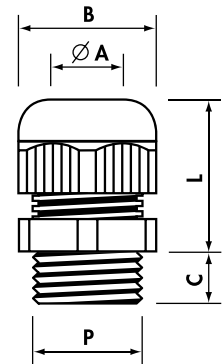

1900

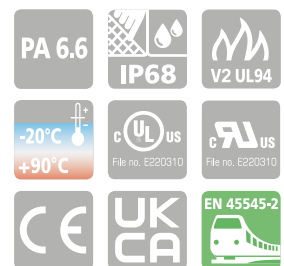

1500

SPIRALBLOCK CABLE GLANDS

Polyamide PA6.6

spiralblock®



Metric thread M 1.5 pitch CEI EN 60423 CEI EN 62444

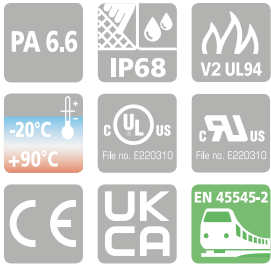

Material: POLYAMIDE PA6.6
self-extinguishing class V2 (UL 94)
Temperature range:
-20°C to +90°C (continuous)
Sealing ring: NEOPRENE®
Protection: IP 68
Colour: RAL 7035 light grey,
RAL 9005 black

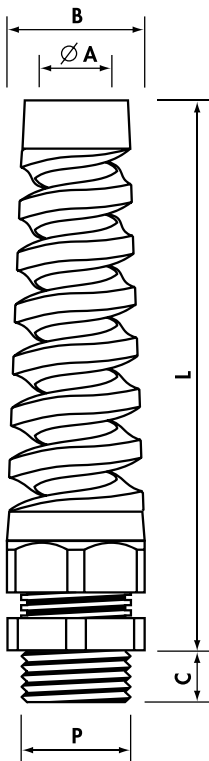

Type Light Grey	P	Fixing Hole Ø (mm)	Ø A min-max (mm)	B Spanner (mm)	C (mm)	L max (mm)	Quantity
1500.M12	M12x1,5	12,2	3,5- 7	15	8	57	100
1500.M16	M16x1,5	16,2	5 -10	19	8	79	50
1500.M20	M20x1,5	20,5	7 -13	25	9	90	25
1500.M25	M25x1,5	25,4	10 -17	30	10	120	20
1500.M32	M32x1,5	32,5	13 -21	36	10	140	10

Add to Ref: N for Black

Pg thread DIN 40 430

Type Light Grey	P	Fixing Hole Ø (mm)	Ø A min-max (mm)	B Spanner (mm)	C (mm)	L max (mm)	Quantity
1500.07	Pg 7	12,7	3,5- 7	15	8	57	100
1500.09	Pg 9	15,5	5 - 8	19	8	68	100
1500.11	Pg11	18,8	5 -10	22	8	80	50
1500.13	Pg13,5	20,5	7 -12	24	10	90	50
1500.16	Pg16	22,6	10 -14	27	10	100	25
1500.21	Pg21	28,5	13 -18	33	12	112	20

Add to Ref: N for Black

BSP thread ISO 228/1

Type Light Grey	P	Fixing Hole Ø (mm)	Ø A min-max (mm)	B Spanner (mm)	C (mm)	L max (mm)	Quantity
1500.14	G1/4"	13,5	3- 6,5	15	8	57	100
1500.38	G3/8"	17,0	4- 8	19	9	68	100
1500.12	G1/2"	21,5	7-12	24	10	90	50
1500.34	G3/4"	27,0	13-18	33	12	112	20

Add to Ref: N for Black

MAXIBLOCK ATEX CABLE GLANDS

Polyamide PA6.6

4900

MAXIblock[®]

Metric thread M 1.5 pitch CEI EN 60423 CEI EN 62444



Type Light Grey	P	Fixing Hole Ø (mm)	Ø A min-max (mm)	B Spanner (mm)	C (mm)	L min-max (mm)	Quantity
4900.M12	M12x1,5	12,2	3,5- 6,5	15	8	18-22	100
4900.M16	M16x1,5	16,2	6,5-10	19	8	22-27	100
4900.M20	M20x1,5	20,5	9 -13	25	9	24-30	100
4900.M25	M25x1,5	25,4	11 -17	30	10	28-39	50
4900.M32	M32x1,5	32,5	16 -21	36	10	33-44	25
4900.M40	M40x1,5	40,5	21 -28	46	10	36-45	15
4900.M50	M50x1,5	50,5	27 -35	55	12	43-52	10
4900.M63	M63x1,5	64,0	35 -42	66	12	45-55	5

extended thread

Type Light Grey	P	Fixing Hole Ø (mm)	Ø A min-max (mm)	B Spanner (mm)	C (mm)	L min-max (mm)	Quantity
4901.M12	M12x1,5	12,2	3,5- 6,5	15	15	18-22	100
4901.M16	M16x1,5	16,2	6,5-10	19	15	22-27	100
4901.M20	M20x1,5	20,5	9 -13	25	15	24-30	50
4901.M25	M25x1,5	25,4	11 -17	30	15	30-41	50
4901.M32	M32x1,5	32,5	16 -21	36	15	33-44	25
4901.M40	M40x1,5	40,5	21 -28	46	18	36-45	15
4901.M50	M50x1,5	50,5	27 -35	55	18	43-52	10
4901.M63	M63x1,5	64,0	35 -42	66	18	45-55	5

Pg thread DIN 40 430

Type Light Grey	P	Fixing Hole Ø (mm)	Ø A min-max (mm)	B Spanner (mm)	C (mm)	L min-max (mm)	Quantity
4900.07	Pg 7	12,7	3,5- 6,5	15	8	18-22	100
4900.09	Pg 9	15,5	6,5- 8	19	8	22-26	100
4900.11	Pg11	18,8	8 -10	22	8	23-28	100
4900.13	Pg13,5	20,5	9 -12	24	9	24-29	100
4900.16	Pg16	22,6	10 -14	27	10	26-31	50
4900.21	Pg21	28,5	14 -18	33	12	30-35	50
4900.29	Pg29	37,2	18 -22	42	12	33-39	25
4900.36	Pg36	47,2	22 -32	53	14	42-49	10
4900.42	Pg42	54,2	28 -38	60	14	42-50	5
4900.48	Pg48	60,0	38 -45	66	15	45-55	5

extended thread

Type Light Grey	P	Fixing Hole Ø (mm)	Ø A min-max (mm)	B Spanner (mm)	C (mm)	L min-max (mm)	Quantity
4901.07	Pg 7	12,7	3,5- 6,5	15	15	18-22	100
4901.09	Pg 9	15,5	6,5- 8	19	15	22-26	100
4901.11	Pg11	18,8	8 -10	22	15	23-28	100
4901.13	Pg13,5	20,5	9 -12	24	15	24-29	100
4901.16	Pg16	22,6	10 -14	27	15	26-31	50
4901.21	Pg21	28,5	14 -18	33	15	30-35	50
4901.29	Pg29	37,2	18 -22	42	15	33-39	25
4901.36	Pg36	47,2	22 -32	53	18	42-49	10
4901.42	Pg42	54,2	28 -38	60	18	42-50	5
4901.48	Pg48	60,0	38 -45	66	18	45-55	5



Certificate No IMQ 10 ATEX 028X

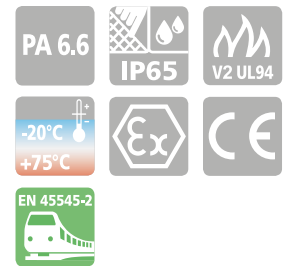

Material: POLYAMIDE PA6.6
self-extinguishing class V2 (UL 94)
Safety level:
Ex eb IIC Gb/Ex tb IIIC Db
according to:
EN 60079-0
EN 60079-7
EN 60079-7/A1
EN 60079-31
Areas of utilisation: 1 & 2, 21 & 22
Temperature range:
-20°C to +75°C (continuous)
Sealing ring: NEOPRENE®
Protection: IP 65
Colour: RAL 7035 light grey

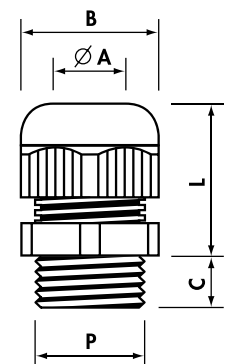

1700 1400

COMPRESSION CABLE GLANDS

Polyamide PA6



Pg thread DIN 40 430 - Dimensions DIN 46 320

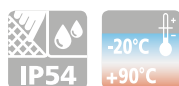

Material: POLYAMIDE PA6 / PA6.6**
self-extinguishing class V0 / V2** (UL 94)
Temperature range:
-20°C to +90°C (continuous)
Sealing ring: PVC 50 sh A
Protection: IP 54
Colour: RAL 7035 light grey,
RAL 9005 black

Type Light Grey	P	Fixing Hole Ø (mm)	Ø A min-max (mm)	B1 Spanner Head (mm)	B2 Spanner Body (mm)	C (mm)	L min-max (mm)	Quantity Box/Bag
1709	Pg 7	12,7	5,5- 7	15	16	8	16-20	300/100
*1700	Pg 9	15,5	6,5- 8,5	17	20	8	19-22	200/100
*1701	Pg11	18,8	8 -10	19	22	8	21-25	100/100
*1702**	Pg13,5	20,5	8 -11	21	24	9	22-26	100/100
1703	Pg16	22,6	11 -14	23	27	10	24-33	50/50
1704	Pg21	28,5	14,5-18	30	33	11	25-32	50/25
1705	Pg29	37,2	19 -26	40	42	11	27-32	20/10
1706	Pg36	47,2	30 -34	50	53	14	33-42	10/10
1707	Pg42	54,2	30 -38	55	60	13	37-48	5/5
1708	Pg48	60,0	38 -44	60	65	14,5	37-48	5/5

*Add to Ref: N for Black

BSP thread ISO 228/1

Type Light Grey	P	Fixing Hole Ø (mm)	Ø A min-max (mm)	B1 Spanner Head (mm)	B2 Spanner Body (mm)	C (mm)	L min-max (mm)	Quantity Box/Bag
1400	G1/4"	13,5	5,5- 7	15	16	8	16-20	300/100
*1401	G3/8"	17,0	6,5- 8,5	17	20	8	19-22	200/100
*1401B	G3/8"	17,0	8 -10	19	22	8	18-24	100/100
*1402**	G1/2"	21,5	8 -11	21	24	9	22-26	100/100
1403	G5/8"	23,5	11 -14	23	27	10	24-33	50/50
1404	G3/4"	27,0	14,5-18	30	33	11	25-32	50/25
1405	G1"	34,0	17 -22	34	38	11,5	27-35	20/10
1407	G1"1/2	48,0	30 -34	50	53	14	33-42	10/10
1408	G2"	60,0	38 -44	60	65	14,5	37-48	5/5

*Add to Ref: N for Black

Metric thread M 1.5 pitch CEI EN 60423

Type Light Grey	P	Fixing Hole Ø (mm)	Ø A min-max (mm)	B1 Spanner Head (mm)	B2 Spanner Body (mm)	C (mm)	L min-max (mm)	Quantity
1730M20**	M20x1,5	20,5	8-11	21	24	9	22-26	100

Add to Ref: N for Black

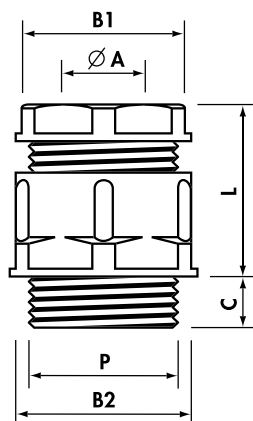

COMPRESSION CABLE GLANDS

Polyamide PA6

1700T



PA 6  V0 UL94

PA 6.6  V2 UL94 **

IP54  -20°C to +90°C

special Internal blanking disc: PVC 50 sh

Pg thread DIN 40 430 - Dimensions DIN 46 320

Type Light Grey	P	Fixing Hole Ø (mm)	Ø A min-max (mm)	B1 Spanner Head (mm)	B2 Spanner Body (mm)	C (mm)	L min-max (mm)	Quantity Box/Bag
*1700T	Pg 9	15,5	6,5- 8,5	17	20	8	19-22	200/100
*1701T	Pg11	18,8	8 -10	19	22	8	21-25	100/100
1702T**	Pg13,5	20,5	8 -11	21	24	9	22-26	100/100

*Add to Ref: N for Black

reduced cable entry

Sealing ring: CHLOROPRENE, concentric, multi-sector

Pg thread DIN 40 430 - Dimensions DIN 46 320

Type Light Grey	P	Fixing Hole Ø (mm)	Ø A min-max (mm)	B1 Spanner Head (mm)	B2 Spanner Body (mm)	C (mm)	L min-max (mm)	Quantity
1702CONC**	Pg13,5	20,5	5,5-13	21	24	9	22-26	100

Add to Ref: N for Black

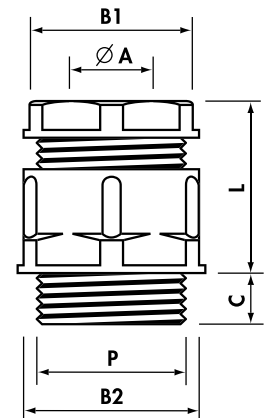

POLYSTYRENE CABLE GLANDS

Polystyrene PS

1700P



PS  -20°C to +60°C

Sealing ring: PVC 50 sh A - Protection: IP 54

Pg thread DIN 40 430 - Dimensions DIN 46 320

Type Light Grey	P	Fixing Hole Ø (mm)	Ø A min-max (mm)	B1 Spanner Head (mm)	B2 Spanner Body (mm)	C (mm)	L min-max (mm)	Quantity Box/Bag
1700P	Pg9	15,5	7- 8,5	17	20	8	19-22	200/100
*1701P	Pg11	18,8	8 -10	19	22	8	21-25	100/100
*1702P	Pg13,5	20,5	8 -11	21	24	9	22-26	100/100
1703P	Pg16	22,6	11 -14	23	27	10	24-33	50/50
1704P	Pg21	28,5	14,5-18	30	33	11	25-32	50/25

*Add to Ref: N for Black

Material: POLYSTYRENE PS
Temperature range:
-20°C to +60°C (continuous)
Colour: RAL 7035 light grey,
RAL 9005 black

2900

MAXIBRASS CABLE GLANDS

Nickel Plated Brass

MAXIbrass®



Material: NICKEL PLATED BRASS
(CuZn 40 Pb 3)
Sealing-ring: NEOPRENE®
Cable grip insert: POLYAMIDE PA6.6
O-Ring: NITRILE 70 sh A (factory fitted)
Protection: IP 68
Temperature range:
-25°C to +100°C (continuous)

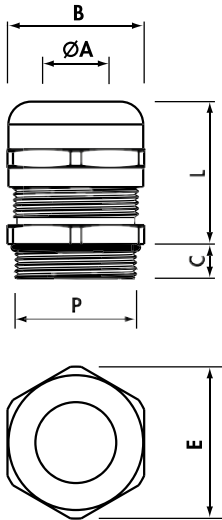

standard

Metric thread M 1.5 pitch CEI EN 60423 CEI EN 62444

Type Nickel Plated Brass	P	Fixing Hole Ø (mm)	Ø A min-max (mm)	B Spanner (mm)	E (mm)	C (mm)	L min-max (mm)	Quantity
2900.M12N	M12x1,5	12,2	3 - 7	16	18	6,5	16-20	100
2900.M16N	M16x1,5	16,2	4,5-10	20	23	7,0	20-25	100
2900.M20N	M20x1,5	20,5	7 -13	24	27	8,0	20-27	50
2900.M25N	M25x1,5	25,4	10 -17	29	32	8,0	24-30	50
2900.M32N	M32x1,5	32,5	11 -21	36	40	9,0	27-34	25
2900.M40N	M40x1,5	40,5	19 -28	45	50	9,0	34-42	10
2900.M50N	M50x1,5	50,5	26 -35	54	60	10,0	35-43	8
2900.M63N	M63x1,5	64,0	34 -45	67	74	15,0	40-52	5

reduced cable entry

Metric thread M 1.5 pitch CEI EN 60423 CEI EN 62444

Type Nickel Plated Brass	P	Fixing Hole Ø (mm)	Ø A min-max (mm)	B Spanner (mm)	E (mm)	C (mm)	L min-max (mm)	Quantity
2910.M12N	M12x1,5	12,2	1 - 5	16	18	6,5	16-20	100
2910.M16N	M16x1,5	16,2	2,5- 7	20	23	7,0	20-25	100
2910.M20N	M20x1,5	20,5	5 -10	24	27	8,0	20-27	50
2910.M25N	M25x1,5	25,4	6 -13	29	32	8,0	24-30	50
2910.M32N	M32x1,5	32,5	7 -14	36	40	9,0	27-34	25
2910.M40N	M40x1,5	40,5	13 -23	45	50	9,0	34-42	10
2910.M50N	M50x1,5	50,5	20 -29	54	60	10,0	35-43	8
2910.M63N	M63x1,5	64,0	27 -39	67	74	15,0	40-52	5

MAXIBRASS CABLE GLANDS

Nickel Plated Brass

MAXIbrass®

2900



extended thread

Metric thread M 1.5 pitch CEI EN 60423 CEI EN 62444

Type Nickel Plated Brass	P	Fixing Hole Ø (mm)	Ø A min-max (mm)	B Spanner (mm)	E (mm)	C (mm)	L min-max (mm)	Quantity
2901.M12N	M12x1,5	12,2	3 - 7	16	18	12	16-20	100
2901.M16N	M16x1,5	16,2	4,5-10	20	23	12	20-25	100
2901.M20N	M20x1,5	20,5	7 -13	24	27	12	20-27	50
2901.M25N	M25x1,5	25,4	10 -17	29	32	12	24-30	50
2901.M32N	M32x1,5	32,5	11 -21	36	40	15	27-34	25
2901.M40N	M40x1,5	40,5	19 -28	45	50	15	34-42	10
2901.M50N	M50x1,5	50,5	26 -35	54	60	15	35-43	8

extended thread and reduced cable entry

Metric thread M 1.5 pitch CEI EN 60423 CEI EN 62444

Type Nickel Plated Brass	P	Fixing Hole Ø (mm)	Ø A min-max (mm)	B Spanner (mm)	E (mm)	C (mm)	L min-max (mm)	Quantity
2911.M12N	M12x1,5	12,2	1 - 5	16	18	12	16-20	100
2911.M16N	M16x1,5	16,2	2,5- 7	20	23	12	20-25	100
2911.M20N	M20x1,5	20,5	5 -10	24	27	12	20-27	50
2911.M25N	M25x1,5	25,4	6 -13	29	32	12	24-30	50
2911.M32N	M32x1,5	32,5	7 -14	36	40	15	27-34	25
2911.M40N	M40x1,5	40,5	13 -23	45	50	15	34-42	10
2911.M50N	M50x1,5	50,5	20 -29	54	60	15	35-43	8



Material: NICKEL PLATED BRASS (CuZn 40 Pb 3)
 Sealing-ring: NEOPRENE®
 Cable grip insert: POLYAMIDE PA6.6
 O-Ring: NITRILE 70 sh A (factory fitted)
 Protection: IP 68
 Temperature range: -25°C to +100°C (continuous)

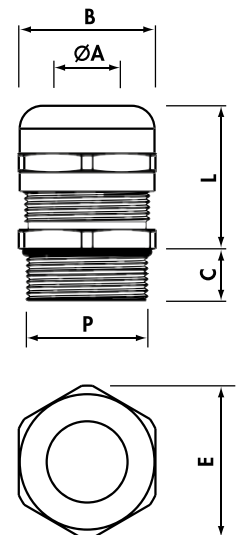



Material: NICKEL PLATED BRASS
(CuZn 40 Pb 3)
Sealing-ring: NEOPRENE®
Cable grip insert: POLYAMIDE PA6.6
O-Ring: NITRILE 70 sh A (factory fitted)
Protection: IP 68
Temperature range:
-25°C to +100°C (continuous)

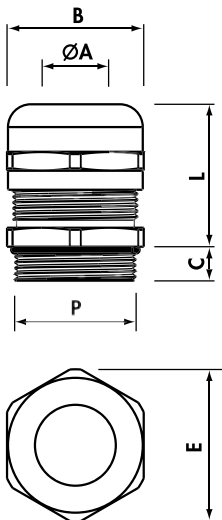

standard

Pg thread DIN 40 430

Type Nickel Plated Brass	P	Fixing Hole Ø (mm)	Ø A min-max (mm)	B Spanner (mm)	E (mm)	C (mm)	L min-max (mm)	Quantity
2900.07N	Pg 7	12,7	3 - 7	16	18	5,0	16-20	100
2900.09N	Pg 9	15,5	4 - 8	17	19	6,0	17-23	100
2900.11N	Pg11	18,8	4,5-10	20	23	6,0	20-25	100
2900.13N	Pg13,5	20,5	5 -12	22	25	6,5	20-26	50
2900.16N	Pg16	22,6	7 -13	24	27	6,5	20-27	50
2900.21N	Pg21	28,5	10 -17	30	33	7,0	24-30	50
2900.29N	Pg29	37,2	17 -25	40	45	8,0	30-37	25
2900.36N	Pg36	47,2	20 -32	50	55	8,0	38-48	10
2900.42N	Pg42	54,2	28 -38	57	63	10,0	39-48	5
2900.48N	Pg48	60,0	34 -45	67	74	15,0	40-52	5

reduced cable entry

Pg thread DIN 40 430

Type Nickel Plated Brass	P	Fixing Hole Ø (mm)	Ø A min-max (mm)	B Spanner (mm)	E (mm)	C (mm)	L min-max (mm)	Quantity
2910.07N	Pg 7	12,7	1 - 5	16	18	5,0	16-20	100
2910.09N	Pg 9	15,5	2 - 6	17	19	6,0	17-23	100
2910.11N	Pg11	18,8	2,5- 7	20	23	6,0	20-25	100
2910.13N	Pg13,5	20,5	4 -10	22	25	6,5	20-26	50
2910.16N	Pg16	22,6	5 -10	24	27	6,5	20-27	50
2910.21N	Pg21	28,5	6 -13	30	33	7,0	24-30	50
2910.29N	Pg29	37,2	11 -20	40	45	8,0	30-37	25
2910.36N	Pg36	47,2	18 -26	50	55	8,0	38-48	10
2910.42N	Pg42	54,2	24 -31	57	63	10,0	39-48	5
2910.48N	Pg48	60,0	27 -39	67	74	15,0	40-52	5

extended thread

Pg thread DIN 40 430

Type Nickel Plated Brass	P	Fixing Hole Ø (mm)	Ø A min-max (mm)	B Spanner (mm)	E (mm)	C (mm)	L min-max (mm)	Quantity
2901.07N	Pg 7	12,7	3 - 7	16	18	12	16-20	100
2901.09N	Pg 9	15,5	4 - 8	17	19	12	17-23	100
2901.11N	Pg11	18,8	4,5-10	20	23	12	20-25	100
2901.13N	Pg13,5	20,5	5 -12	22	25	12	20-26	50
2901.16N	Pg16	22,6	7 -13	24	27	12	20-27	50
2901.21N	Pg21	28,5	10 -17	30	33	12	24-30	50
2901.29N	Pg29	37,2	17 -25	40	45	15	30-37	25
2901.36N	Pg36	47,2	20 -32	50	55	15	38-48	10
2901.42N	Pg42	54,2	28 -38	57	63	15	39-48	5

MAXIBRASS CABLE GLANDS

Nickel Plated Brass

MAXIbrass®

extended thread and reduced cable entry

Pg thread DIN 40 430

Type Nickel Plated Brass	P	Fixing Hole Ø (mm)	Ø A min-max (mm)	B Spanner (mm)	E (mm)	C (mm)	L min-max (mm)	Quantity
2911.07N	Pg 7	12,7	1 - 5	16	18	12	16-20	100
2911.09N	Pg 9	15,5	2 - 6	17	19	12	17-23	100
2911.11N	Pg11	18,8	2,5- 7	20	23	12	20-25	100
2911.13N	Pg13,5	20,5	4 -10	22	25	12	20-26	50
2911.16N	Pg16	22,6	5 -10	24	27	12	20-27	100
2911.21N	Pg21	28,5	6 -13	30	33	12	24-30	50
2911.29N	Pg29	37,2	11 -20	40	45	15	30-37	25
2911.36N	Pg36	47,2	18 -26	50	55	15	38-48	10
2911.42N	Pg42	54,2	24 -31	57	63	15	39-48	5



MAXIBRASS CABLE GLANDS

Nickel Plated Brass

standard, factory fitted with Polyethylene foam dustproof discs

Metric thread M 1.5 pitch CEI EN 60423 CEI EN 62444

Type Nickel Plated Brass	P	Fixing Hole Ø (mm)	Ø A min-max (mm)	B Spanner (mm)	E (mm)	C (mm)	L min-max (mm)	Quantity
2900DP.M12N	M12x1,5	12,2	3 - 7	16	18	6,5	16-20	100
2900DP.M16N	M16x1,5	16,2	4,5-10	20	23	7,0	20-25	100
2900DP.M20N	M20x1,5	20,5	7 -13	24	27	8,0	20-27	50
2900DP.M25N	M25x1,5	25,4	10 -17	29	32	8,0	24-30	50
2900DP.M32N	M32x1,5	32,5	11 -21	36	40	9,0	27-34	25
2900DP.M40N	M40x1,5	40,5	19 -28	45	50	9,0	34-42	10
2900DP.M50N	M50x1,5	50,5	26 -35	54	60	10,0	35-43	8
2900DP.M63N	M63x1,5	64,0	34 -45	67	74	15,0	40-52	5

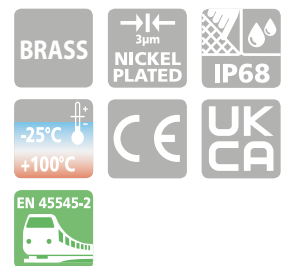

Pg thread DIN 40 430

Type Nickel Plated Brass	P	Fixing Hole Ø (mm)	Ø A min-max (mm)	B Spanner (mm)	E (mm)	C (mm)	L min-max (mm)	Quantity
2900DP.07N	Pg 7	12,7	3 - 7	16	18	5,0	16-20	100
2900DP.09N	Pg 9	15,5	4 - 8	17	19	6,0	17-23	100
2900DP.11N	Pg11	18,8	4,5-10	20	23	6,0	20-25	100
2900DP.13N	Pg13,5	20,5	5 -12	22	25	6,5	20-26	50
2900DP.16N	Pg16	22,6	7 -13	24	27	6,5	20-27	50
2900DP.21N	Pg21	28,5	10 -17	30	33	7,0	24-30	50
2900DP.29N	Pg29	37,2	17 -25	40	45	8,0	30-37	25
2900DP.36N	Pg36	47,2	20 -32	50	55	8,0	38-48	10
2900DP.42N	Pg42	54,2	28 -38	57	63	10,0	39-48	5
2900DP.48N	Pg48	60,0	34 -45	67	74	15,0	40-52	5

Material: NICKEL PLATED BRASS (CuZn 40 Pb 3)
 Sealing-ring: NEOPRENE®
 Cable grip insert: POLYAMIDE PA6.6
 O-Ring: NITRILE 70 sh A (factory fitted)
 Protection: IP 68
 Dustproof discs: 2 mm thick
 Polyethylene foam
 Temperature range: -25°C to +100°C (continuous)

5900



Material: NICKEL PLATED BRASS
 Sealing-ring: NEOPRENE®
 Cable grip insert: POLYAMIDE PA6.6
 O-Ring: NITRILE 70 sh A (factory fitted)
 Temperature range:
 -25°C to +75°C (continuous)
 Protection: IP 65

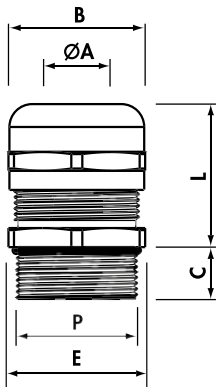

20M3

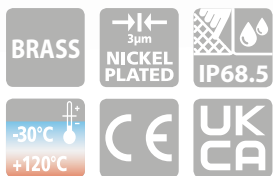

Material: NICKEL PLATED BRASS
 (CuZn 40 Pb 3)
 Sealing-ring: Chloroprene (CR)
 Cable grip insert: PA6.6
 O-Ring: (NBR) (factory fitted)
 Protection: IP 68.5
 Temperature range:
 -30°C to +120°C (continuous)

MAXIBRASS ATEX CABLE GLANDS

Nickel Plated Brass



Certificate No IMQ 10 ATEX 028X

Safety level: Ex eb IIC Gb/Ex tb IIIC Db
 according to: EN 60079-0
 EN 60079-7
 EN 60079-7/A1; EN 60079-31
 Areas of utilisation: 1 & 2, 21 & 22

MAXIbrass®

Metric thread M 1.5 pitch CEI EN 60423 CEI EN 62444

Type Nickel Plated Brass	P	Fixing Hole Ø (mm)	Ø A min-max (mm)	B Spanner (mm)	E (mm)	C (mm)	L min-max (mm)	Quantity
5900.M12N	M12x1,5	12,2	3 - 6,5	16	18	6,5	16-20	100
5900.M16N	M16x1,5	16,2	6,5 - 10	20	23	7,0	20-25	100
5900.M20N	M20x1,5	20,5	10 - 13	24	27	8,0	20-27	50
5900.M25N	M25x1,5	25,4	11 - 17	29	32	8,0	24-30	50
5900.M32N	M32x1,5	32,5	14 - 21	36	40	9,0	27-34	25
5900.M40N	M40x1,5	40,5	21 - 27	45	50	9,0	34-42	10
5900.M50N	M50x1,5	50,5	26 - 35	54	60	10,0	35-43	8
5900.M63N	M63x1,5	64,0	35 - 42	67	74	15,0	40-52	5

extended thread

Type Nickel Plated Brass	P	Fixing Hole Ø (mm)	Ø A min-max (mm)	B Spanner (mm)	E (mm)	C (mm)	L min-max (mm)	Quantity
5901.M12N	M12x1,5	12,2	3 - 6,5	16	18	12	16-20	100
5901.M16N	M16x1,5	16,2	6,5 - 10	20	23	12	20-25	100
5901.M20N	M20x1,5	20,5	10 - 13	24	27	12	20-27	50
5901.M25N	M25x1,5	25,4	11 - 17	29	32	12	24-30	50
5901.M32N	M32x1,5	32,5	14 - 21	36	40	12	27-34	25
5901.M40N	M40x1,5	40,5	21 - 27	45	50	12	34-42	10
5901.M50N	M50x1,5	50,5	26 - 35	54	60	12	35-43	8

EMC CABLE GLANDS

Nickel Plated Brass

Metric thread M 1.5 pitch CEI EN 60423 CEI EN 62444

Type Nickel Plated Brass	P	Fixing Hole Ø (mm)	Ø A min-max (mm)	B Spanner (mm)	C (mm)	L max (mm)	Quantity Box/Bag
20M3M1261N	M12x1,5	12,2	3 - 6,5	14	5,0	22,0	300/100
20M3M1661N	M16x1,5	16,2	5,5 - 10	17	5,5	24,5	200/100
20M3M2061N	M20x1,5	20,5	8 - 13	22	6,0	27,0	100/50
20M3M2561N	M25x1,5	25,4	11 - 18	30	7,0	31,0	50/25
20M3M3261N	M32x1,5	32,5	15 - 21	34	8,0	33,0	30/10
20M3M4061N	M40x1,5	40,5	19 - 27	44	8,0	40,0	20/10
20M3M5061N	M50x1,5	50,5	26 - 35	55	9,0	48,0	10/5
20M3M6361N	M63x1,5	64,0	39 - 48	66	10,0	50,0	5/5

EMC Cable glands and locknuts are designed to work together in electrical or electronic applications where a metallic cable shielding must be equipotential with a metallic enclosure, in accordance with the EMC directive.

Offering IP68 ingress protection at 5 bar pressure, EMC Cable glands will maintain shielding from electromagnetic disturbance in underground applications.

EMC locknuts have serrated teeth to maintain electrical contact through paint or surface coatings, a feature which also enhances vibration resistance.

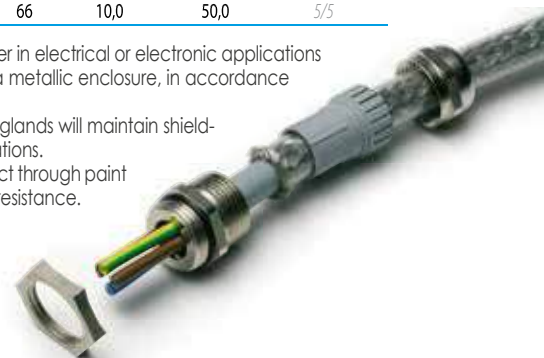

COMPRESSION CABLE GLANDS

Nickel Plated Brass

2003
2002
2001

Sealing ring: RUBBER 55sh A

Metric thread M 1.5 pitch CEI EN 60423 CEI EN 62444

Type Nickel Plated Brass	P	Fixing Hole Ø (mm)	Ø A min-max (mm)	B1 Spanner Head (mm)	B2 Spanner Body (mm)	C (mm)	L min-max (mm)	Quantity Box/Bag
2003M1221N	M12x1,5	12,2	4 - 6	13	14	5	13-16	500/100
2003M1621N	M16x1,5	16,2	8 -10	15	18	5	14-17	200/100
2003M2021N	M20x1,5	20,5	10 -12	20	22	6	16-19	150/50
2003M2521N	M25x1,5	25,4	17 -19	28	30	7	19-23	50/50
2003M3221N	M32x1,5	32,5	26 -28	37	39	8	21-25	100/50
2003M4021N	M40x1,5	40,5	33 -35	47	50	8	24-30	20/20
2003M5021N	M50x1,5	50,5	39 -41	54	57	9	28-34	10/5
2003M6321N	M63x1,5	64,0	43 -45	60	66/68	10	30-36	10/5

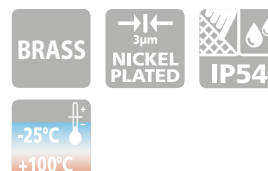

Sealing ring: RUBBER 55sh A

Pg thread DIN 40 430 - Dimensions DIN 46 320

Type Nickel Plated Brass	P	Fixing Hole Ø (mm)	Ø A min-max (mm)	B1 Spanner Head (mm)	B2 Spanner Body (mm)	C (mm)	L min-max (mm)	Quantity Box/Bag
200200721N	Pg 7	12,7	5 - 7	13	14	5	13-16	400/100
200200921N	Pg 9	15,5	8 -10	15	17	6	14-17	300/100
200201121N	Pg11	18,8	8 -10	18	20	6	14-18	200/50
200201321N	Pg13,5	20,5	10 -12	20	22	6,5	16-19	100/50
200201621N	Pg16	22,6	12 -14	22	24	6,5	17-20	50/50
200202121N	Pg21	28,5	17 -19	28	30	7	19-23	50/50
200202921N	Pg29	37,2	26 -28	37	40	8	21-25	15/15
200203621N*	Pg36	47,2	33 -35	47	50	9	24-30	10/10
200204221N	Pg42	54,2	39 -41	54	57	10	28-34	10/10
200204821N*	Pg48	60,0	43 -45	60	64	10	36-45	10/10

* Double sealing ring

Material: NICKEL PLATED BRASS
(CuZn 40 Pb 3)
Protection: IP 54

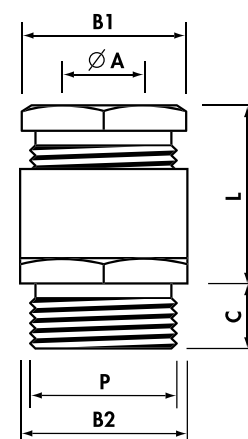

Sealing ring: PVC 50 sh A

BSP thread ISO 228/1

Type Nickel Plated Brass	P	Fixing Hole Ø (mm)	Ø A min-max (mm)	B1 Spanner Head (mm)	B2 Spanner Body (mm)	C (mm)	L min-max (mm)	Quantity Box/Bag
200101441N	G1/4"	13,5	5,5 - 7	13	15	6,5	14-17	400/100
207101441N**	G1/4"	13,5	5,5 - 7	13	Ø 15	6,5	14-17	400/100
200103841N	G3/8"	17,0	6,5 - 8,5	17	19	7,5	15-19	200/100
200101241N	G1/2"	21,5	8 -11	21	23	8	17-23	100/100
200105841N	G5/8"	23,5	11 -14	23	25	8,5	20-24	100/50
200103441N	G3/4"	27,0	14,5-17,5	27	29	9	20-26	50/50
200110041N	G1"	34,0	18 -22	34	36	10	23-28	25/25
200111841N	G1"1/8	38,0	21 -26	38	40	10,5	23-28	25/25
200111441N	G1"1/4	42,0	28 -32	42	45	11,5	25-31	20/20
200111241N	G1"1/2	48,0	32 -36	48	50	11,5	28-35	10/10
200120041N	G2"	60,0	38 -42	60	64	13,5	31-37	10/10
• 200121221N*	G2"1/2	76,0	44 -57	80	80	20	32-37	5/5
• 200130021N	G3"	89,0	67 -69	95	95	20	42-52	5/5

• Sealing ring: Chloroprene

* Concentric sealing ring

** Cylindrical spanner Body

7900 7900A

MAXIINOX CABLE GLANDS

Stainless Steel AISI 303 (X8 CrNiS 18-9) - Stainless Steel AISI 316L (X2 CrNiMo 17-12-2)



MAXIinox



Material:
STAINLESS STEEL AISI 303/316L
Sealing-ring: NEOPRENE®
Cable grip insert: POLYAMIDE PA6.6
O-Ring: NITRILE 70 sh A
(factory fitted)
Protection: IP 68
Temperature range:
-25°C to +100°C (continuous)

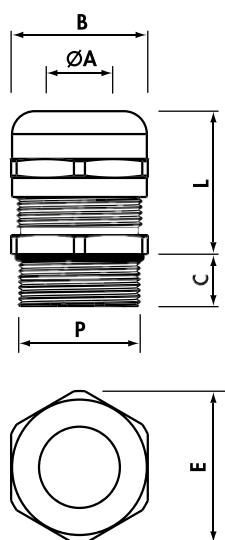

Stainless Steel AISI 303

Metric thread M 1.5 pitch CEI EN 60423 CEI EN 62444

Stainless Steel AISI 303	P	Fixing Hole Ø (mm)	Ø A min-max (mm)	B Spanner (mm)	E (mm)	C (mm)	L min-max (mm)	Quantity Box/Bag
7900.M12	M12x1,5	12,2	3 - 7	16	18	6,5	16-20	90/30
7900.M16	M16x1,5	16,2	4,5-10	20	23	7,0	20-25	120/30
7900.M20	M20x1,5	20,5	7 -13	24	27	8,0	20-27	75/25
7900.M25	M25x1,5	25,4	10 -17	29	32	8,0	24-30	40/20
7900.M32	M32x1,5	32,5	11 -21	36	40	9,0	27-34	15
7900.M40	M40x1,5	40,5	19 -28	45	50	9,0	34-42	15
7900.M50	M50x1,5	50,5	26 -35	54	60	10,0	35-43	10
7900.M63	M63x1,5	64,0	34 -45	67	74	15,0	40-52	5

Stainless Steel AISI 316L

Metric thread M 1.5 pitch CEI EN 60423 CEI EN 62444

Stainless Steel AISI 316L	P	Fixing Hole Ø (mm)	Ø A min-max (mm)	B Spanner (mm)	E (mm)	C (mm)	L min-max (mm)	Quantity Box/Bag
7900A.M12	M12x1,5	12,2	3 - 7	16	18	6,5	16-20	60/20
7900A.M16	M16x1,5	16,2	4,5-10	20	23	7,0	20-25	80/20
7900A.M20	M20x1,5	20,5	7 -13	24	27	8,0	20-27	60/20
7900A.M25	M25x1,5	25,4	10 -17	29	32	8,0	24-30	30/15
7900A.M32	M32x1,5	32,5	11 -21	36	40	9,0	27-34	12
7900A.M40	M40x1,5	40,5	19 -28	45	50	9,0	34-42	10
7900A.M50	M50x1,5	50,5	26 -35	54	60	10,0	35-43	7
7900A.M63	M63x1,5	64,0	34 -45	67	74	15,0	40-52	5

MAXIINOX CABLE GLANDS

Stainless Steel AISI 303 (X8 CrNiS 18-9) - Stainless Steel AISI 316L (X2 CrNiMo 17-12-2)

7900 7900A

MAXIinox



Stainless Steel AISI 303

Pg thread DIN 40 430

Stainless Steel AISI 303	P	Fixing Hole Ø (mm)	Ø A min-max (mm)	B Spanner (mm)	E (mm)	C (mm)	L min-max (mm)	Quantity Box/Bag
7900.07	Pg 7	12,7	3 - 7	16	18	5,0	16-20	90/30
7900.09	Pg 9	15,5	4 - 8	17	19	6,0	17-23	90/30
7900.11	Pg11	18,8	4,5-10	20	23	6,0	20-25	60/30
7900.13	Pg13,5	20,5	5 - 12	22	25	6,5	20-26	90/30
7900.16	Pg16	22,6	7 - 13	24	27	6,5	20-27	60/30
7900.21	Pg21	28,5	10 - 17	30	33	7,0	24-30	40/20
7900.29	Pg29	37,2	17 - 25	40	45	8,0	30-37	30/15
7900.36	Pg36	47,2	20 - 32	50	55	8,0	38-48	10
7900.42	Pg42	54,2	28 - 38	57	63	10,0	36-46	5
7900.48	Pg48	60,0	34 - 45	67	74	15,0	40-52	5

Material:
STAINLESS STEEL AISI 303/316L
Sealing-ring: NEOPRENE®
Cable grip insert: POLYAMIDE PA6.6
O-Ring: NITRILE 70 sh A
(factory fitted)
Protection: IP 68
Temperature range:
-25°C to +100°C (continuous)

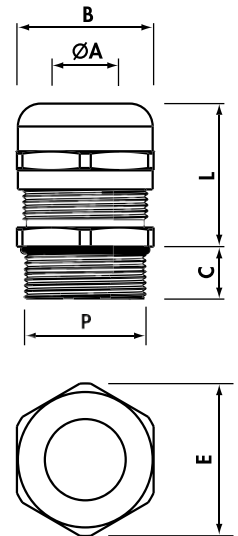

Stainless Steel AISI 316L

Pg thread DIN 40 430

Stainless Steel AISI 316L	P	Fixing Hole Ø (mm)	Ø A min-max (mm)	B Spanner (mm)	E (mm)	C (mm)	L min-max (mm)	Quantity Box/Bag
7900A.07	Pg 7	12,7	3 - 7	16	18	5,0	16-20	60/20
7900A.09	Pg 9	15,5	4 - 8	17	19	6,0	17-23	60/20
7900A.11	Pg11	18,8	4,5-10	20	23	6,0	20-25	100/20
7900A.13	Pg13,5	20,5	5 - 12	22	25	6,5	20-26	100/20
7900A.16	Pg16	22,6	7 - 13	24	27	6,5	20-27	40/20
7900A.21	Pg21	28,5	10 - 17	30	33	7,0	24-30	60/15
7900A.29	Pg29	37,2	17 - 25	40	45	8,0	30-37	20/10
7900A.36	Pg36	47,2	20 - 32	50	55	8,0	38-48	7
7900A.42	Pg42	54,2	28 - 38	57	63	10,0	36-46	5
7900A.48	Pg48	60,0	34 - 45	67	74	15,0	40-52	5

1143
1142
1141

LOCKNUTS WITH COLLAR

Polyamide PA6.6



PA 6.6



Material: POLYAMIDE PA6.6
self-extinguishing class V2 (UL 94)
Temperature range:
-20°C to +90°C (continuous)
Colour: RAL 7035 light grey,
RAL 9005 black,
RAL 7001 dark grey

Metric thread M 1.5 pitch CEI EN 60423

Type Light Grey	P	Ø A (mm)	B Spanner (mm)	H (mm)	Quantity Box/Bag
1143M12	M12x1,5	18,5	17	5	1.000/100
1143M16	M16x1,5	24,0	22	5	600/100
1143M20	M20x1,5	29,0	27	6	400/100
1143M25	M25x1,5	35,5	32	6	100
1143M32	M32x1,5	45,0	41	7	50
1143M40	M40x1,5	55,0	50	7	30
1143M50	M50x1,5	65,0	60	8	30
1143M63	M63x1,5	82,0	75	8	15

Add to Ref: N for Black, G for Dark Grey

Pg thread DIN 40 430 - Dimensions DIN 46 320

Type Light Grey	P	Ø A (mm)	B Spanner (mm)	H (mm)	Quantity Box/Bag
1142007	Pg 7	21	19	5	100
1142009	Pg 9	24	22	5	700/100
1142011	Pg11	26	24	5	500/100
1142013	Pg13,5	29	27	6	400/100
1142016	Pg16	33	30	6	100
1142021	Pg21	39	36	7	200/50
1142029	Pg29	50	46	7	50
1142036	Pg36	66	60	8	30
1142042	Pg42	73	65	8	25
1142048	Pg48	78	70	8	20

Add to Ref: N for Black, G for Dark Grey

BSP thread ISO 228/1

Type Light Grey	P	Ø A (mm)	B Spanner (mm)	H (mm)	Quantity Box/Bag
1141012	G1/2"	29	27	6	400/100
1141112	G1"1/2	66	60	8	30
1141200	G2"	78	70	8	20

Add to Ref: N for Black

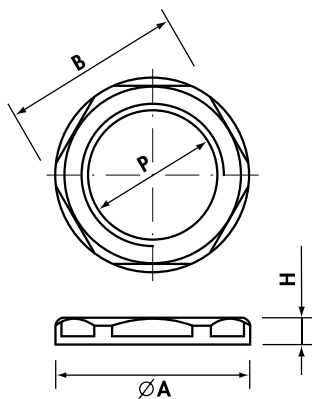

LOCKNUTS WITHOUT COLLAR

Polyamide PA6.6

1112
1710
1410



Metric thread M 1.5 pitch CEI EN 60423

Type Light Grey	P	B Spanner (mm)	H (mm)	Quantity Box/Bag
1112	M12x1,5	17	5	1.000/100
1116	M16x1,5	22	5	700/100
1120	M20x1,5	27	6	400/100
1125	M25x1,5	32	6	100
1132	M32x1,5	41	7	50
1140	M40x1,5	50	7	30
1150	M50x1,5	60	8	30
1163	M63x1,5	75	8	15

Add to Ref: N for Black



Material: POLYAMIDE PA6.6
self-extinguishing class V2 (UL 94)
Temperature range:
-20°C to +90°C (continuous)
Colour: RAL 7035 light grey,
RAL 9005 black

Pg thread DIN 40 430 - Dimensions DIN 46 320

Type Light Grey	P	B Spanner (mm)	H (mm)	Quantity Box/Bag
1719E17*	Pg 7	17	5	1.000/100
1719	Pg 7	19	5	100
1710	Pg 9	22	5	700/100
1711	Pg11	24	5	500/100
1712	Pg13,5	27	6	400/100
1713	Pg16	30	6	100
Δ1714E34*	Pg21	34	7	200/100
1714	Pg21	36	7	200/100
1715	Pg29	46	7,5	100/25

Add to Ref: N for Black

Δ Light Grey only

* Not DIN 46 320

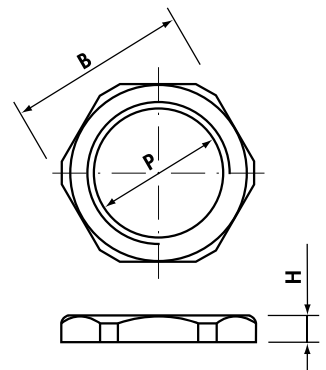

BSP thread ISO 228/1

Type Light Grey	P	B Spanner (mm)	H (mm)	Quantity Box/Bag
1410	G1/4"	19	5	800/100
1411	G3/8"	23	6	600/100
1412	G1/2"	27	6	400/100
1414	G3/4"	34	7	200/100
1415	G1"	40	7	50

Add to Ref: N for Black

2033
2032
2031



LOCKNUTS

Nickel Plated Brass

Metric thread M 1.5 pitch CEI EN 60423

Type Nickel Plated Brass	P	B Spanner (mm)	H (mm)	Quantity Box/Bag
2033M12N	M12x1,5	16	2,8	2.000/100
2033M16N	M16x1,5	19	2,8	1.000/100
2033M20N	M20x1,5	24	3,0	600/100
2033M25N	M25x1,5	30	4,0	300/50
2033M32N	M32x1,5	36	4,0	250/25
2033M40N	M40x1,5	45	5,0	100/10
2033M50N	M50x1,5	60	5,0	100/10
2033M63N	M63x1,5	70	5,5	50/5

Pg thread DIN 40 430 - Dimensions DIN 46 320

Type Nickel Plated Brass	P	B Spanner (mm)	H (mm)	Quantity Box/Bag
2032007N	Pg 7	16*	2,8	1.500/100
2032009N	Pg 9	18	2,8	1.500/100
2032011N	Pg11	21	3,0	1.000/100
2032013N	Pg13,5	23	3,0	1.000/100
2032016N	Pg16	26	3,0	600/100
2032021N	Pg21	32	3,5	500/100
2032029N	Pg29	41	4,0	200/50
2032036N	Pg36	51	5,0	100/10
2032042N	Pg42	60	5,0	50/10
2032048N	Pg48	64	5,5	50/10

*Different dimension to DIN 46320

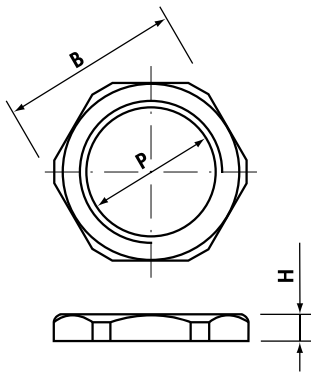

BSP thread ISO 228/1

Type Nickel Plated Brass	P	B Spanner (mm)	H (mm)	Quantity Box/Bag
2031014N	G1/4"	16	3,0	2.400/100
2031038N	G3/8"	19	3,0	1.000/100
2031012N	G1/2"	24	3,5	1.000/100
2031058N	G5/8"	26	4,0	500/50
2031034N	G3/4"	30	4,0	500/50
2031100N	G1"	37	4,0	250/25
2031118N	G1"1/8	41	4,5	100/25
2031114N	G1"1/4	45	4,5	200/20
2031112N	G1"1/2	52	5,5	100/20
2031200N	G2"	64	7,0	50/10
2031212N	G2"1/2	80	7,0	20/5
2031300N	G3"	95	8,0	20/5

EMC LOCKNUTS

Nickel Plated Brass

With serrated teeth to maintain electrical contact

Metric thread M 1.5 pitch CEI EN 60423

Type Nickel Plated Brass	P	B Spanner (mm)	H (mm)	Quantity Box/Bag
20N3M12N	M12x1,5	15	3,5	1000/100
20N3M16N	M16x1,5	19	3,5	1000/100
20N3M20N	M20x1,5	24	3,5	500/100
20N3M25N	M25x1,5	30	4,0	400/100
20N3M32N	M32x1,5	36	4,0	200/100
20N3M40N	M40x1,5	46	4,7	100/50
20N3M50N	M50x1,5	60	5,7	50/50
20N3M63N	M63x1,5	70	6,7	50/25

20N3

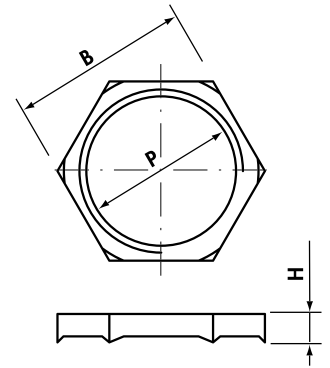

MAXIINOX LOCKNUTS

Stainless Steel AISI 303 (X8 CrNiS 18-9) - Stainless Steel AISI 316L (X2 CrNiMo 17-12-2)

Metric thread M 1.5 pitch CEI EN 60423

Stainless Steel AISI 303	Stainless Steel AISI 316L	P	B Spanner (mm)	H (mm)	AISI 303 Quantity Box/Bag	AISI 316L Quantity Box/Bag
7033M12	7033AM12	M12x1,5	16	2,8	450/30	300/20
7033M16	7033AM16	M16x1,5	20	2,8	450/30	300/20
7033M20	7033AM20	M20x1,5	24	3,5	250/25	200/20
7033M25	7033AM25	M25x1,5	29	4,0	160/20	120/15
7033M32	7033AM32	M32x1,5	36	4,0	105/15	84/12
7033M40	7033AM40	M40x1,5	45	5,0	60/15	40/10
7033M50	7033AM50	M50x1,5	57	5,0	40/10	28/7
7033M63	7033AM63	M63x1,5	70	5,5	32/8	20/5

7032 7033

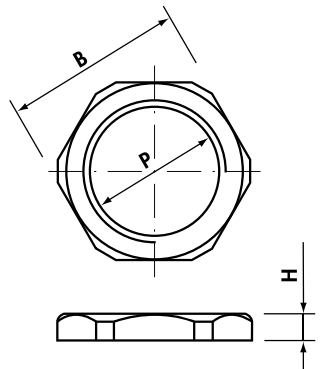

Pg thread DIN 40 430

Stainless Steel AISI 303	Stainless Steel AISI 316L	P	B Spanner (mm)	H (mm)	AISI 303 Quantity Box/Bag	AISI 316L Quantity Box/Bag
7032007	7032A007	Pg 7	16	2,8	450/30	300/20
7032009	7032A009	Pg 9	20	2,8	450/30	300/20
7032011	7032A011	Pg11	22	3,0	300/30	200/20
7032013	7032A013	Pg13,5	22	3,0	300/30	200/20
7032016	7032A016	Pg16	27	3,0	240/30	160/20
7032021	7032A021	Pg21	32	3,5	160/20	150/15
7032029	7032A029	Pg29	41	4,0	60/15	40/10
7032036	7032A036	Pg36	50	5,0	40/10	28/7
7032042	7032A042	Pg42	60	5,0	40/10	20/5
7032048	7032A048	Pg48	64	5,5	32/8	20/5



For cable glands type:

MAXIblock[®]
MAXIbrass[®]
MAXIinox



Material: POLYAMIDE PA6.6
 self-extinguishing class V2 (UL 94)
 Temperature range:
 -20°C to +90°C (continuous)
 Colour: RAL 9005 black

Application:
 Blanking the cable entry of cable glands and maintaining IP 68.

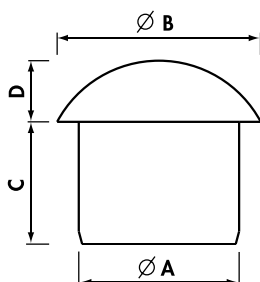

Plugs

Type	Suitable for		Ø A (mm)	Ø B (mm)	C (mm)	D (mm)	Quantity Box/Bag
	MAXIblock [®]	MAXIbrass [®] MAXIinox					
TCP5	M12R + Pg7R	M12R	4,5	8,5	10,8	4,5	3.000/100
TCP10	Pg9R	Pg9R	6,0	12,0	12,0	4,5	2.000/100
TCP12	M12 + Pg7	M12 + Pg7	6,8	12,0	12,0	4,5	1.000/100
	M16R + Pg11R	M16R + Pg11R					
TCP15	Pg9	Pg9	8,0	11,0	11,5	5,0	1.500/100
TCP18	M16 + Pg11	M16 + Pg11	9,5	12,5	13,0	5,0	800/100
TCP20	M20R	M20R	10,0	15,0	14,0	6,0	800/100
	Pg13,5 + Pg13,5R	Pg13 + Pg13,5R					
	Pg16R	Pg16R					
TCP25	M20 + Pg16	M20 + Pg16	12,5	17,0	15,0	8,0	400/100
TCP30	M25R + M32R	M25R + M32R	12,5	22,5	18,0	9,0	300/100
	Pg21R	Pg21R					
TCP35	M25 + Pg21	M25 + Pg21	16,0	19,5	18,0	8,0	200/100
TCP40	M32	M32	19,0	22,5	19,0	9,0	150/50
TCP45	M40R + Pg29 + Pg36R	M40R + Pg29	22,0	30,0	20,0	10,0	100/50
TCP50	M40 + M50R + Pg42R	M40 + M50R	27,5	38,0	25,0	12,0	50/25
TCP55	Pg36	Pg36	31,5	36,5	23,5	12,0	50/25
TCP60	M50	M50	34,5	40,0	23,5	12,0	50/25
TCP65	M63R + Pg42 + Pg48R	M63R + Pg42	37,5	48,0	26,5	12,0	30/15
TCP70	M63 + Pg48	M63 + Pg48	43,0	48,0	26,5	12,0	30/15

R: reduced cable entry

MULTI-ENTRY SEALS FOR CABLE GLANDS

Neoprene® 70 sh A

For cable glands type:

MAXIblock®
MAXIbrass®
MAXIinox

Material: NEOPRENE® 70 sh A
Temperature range:
-40°C to +130°C
Protection: IP 68
Colour: RAL 9005 black

Application:
IP68 sealing of multiple cables
entering cable glands.



36A
36C

Multi-entry seals

Type	Suitable for		No. entries	Ø entries (mm)	Quantity Box/Bag
	MAXIblock®	MAXIbrass® MAXIinox			
36A3M1623	M16 + Pg11	M16 + Pg11	2	3,0	500/100
36A3M1624	M16 + Pg11	M16 + Pg11	2	4,0	1.000/100
36A3M16322	M16 + Pg11	M16 + Pg11	3	2,2	1.000/100
36A3M2025	M20 + Pg13,5	M20 + Pg13,5 + Pg16	2	5,0	500/100
36A3M2026	M20 + Pg13,5	M20 + Pg13,5 + Pg16	2	6,0	500/100
36A3M2034	M20 + Pg13,5	M20 + Pg13,5 + Pg16	3	4,0	500/100
36A3M2035	M20 + Pg13,5	M20 + Pg13,5 + Pg16	3	5,0	500/100
36A3M20356	M20 + Pg13,5	M20 + Pg13,5 + Pg16	3	5,6	500/100
36A3M2526	M25	M25 + Pg21	2	6,0	300/50
36A3M2536	M25	M25 + Pg21	3	6,0	300/50
36A3M2537	M25	M25 + Pg21	3	7,0	300/50
36A3M2545	M25	M25 + Pg21	4	5,0	300/50
36A3M2546	M25	M25 + Pg21	4	6,0	300/50
36A3M2554	M25	M25 + Pg21	5	4,0	300/50
36C3M252105	M25	M25 + Pg21	2	5+10,5	300/50
36A3M3228	M32	M32	2	8,0	150/50
36A3M3239	M32	M32	3	9,0	150/50
36A3M32465	M32	M32	4	6,5	150/50
36A3M3248	M32	M32	4	8,0	150/50
36A3M4078	M40	M40	7	8,0	100/100
36A3M40106	M40	M40	10	6,0	100/100
36A3M5088	M50 + Pg 36	M50 + Pg 36	8	8,0	50/50
36C201629	Pg16	-	2	3+9	400/50

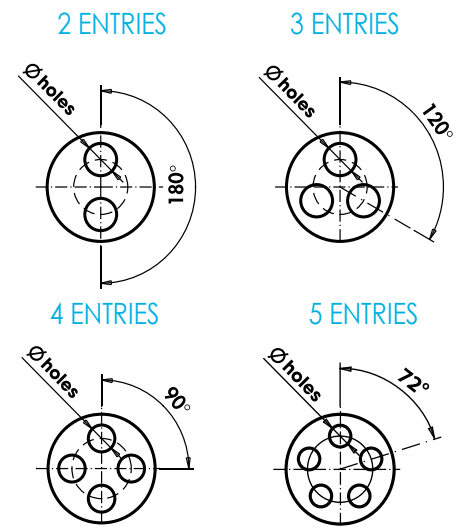

MULTI-ENTRY SEAL PLUGS FOR CABLE GLANDS

Polyamide PA6.6

Material: POLYAMIDE PA6.6
Temperature range:
-20°C to +90°C (continuous)
Colour: RAL 7035 light grey

Application:
Plugging unused entries in multi-entry seals and maintaining IP68.



TGM

Multi-entry seal plugs

Type	Suitable for Seal	Ø A (mm)	L (mm)	Quantity Box/Bag
TGM38	36A3M1623	3	10	5.000/100
TGM48	36A3M1624 + 36A3M2034 + 36A3M2554	4	8	5.000/100
TGM58	36A3M2025	5	8	5.000/100
TGM513	36A3M2545	5	13	2.500/50
TGM613	36A3M2526 + 36A3M2536 + 36A3M40106	6	13	2.000/50
TGM713	36A3M2537	7	13	2.000/50
TGM817	36A3M3248 + 36A3M5088 + 36A3M4078	8	17	100

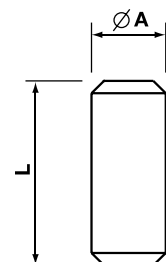

1173M 1153M

ENTRY THREAD ADAPTERS

Polyamide PA6.6



Material:
POLYAMIDE PA6.6
self-extinguishing class V2 (UL 94)
Temperature range:
-40°C to +85°C (continuous)
Colour: RAL 7035 light grey,
RAL 9005 black

Entry thread enlargers

Metric thread M 1.5 pitch CEI EN 60423

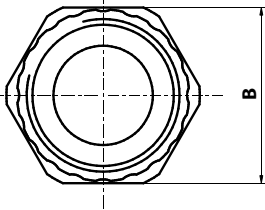
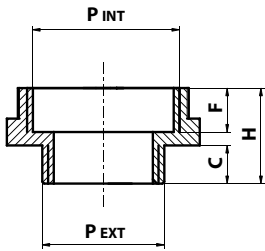

Type	P EXT	P INT	B Spanner (mm)	F (mm)	C (mm)	H (mm)	Quantity Box/Bag
1173M1216	M12x1,5	M16x1,5	20,0	10,5	8,0	21,0	200/100
1173M1620	M16x1,5	M20x1,5	24,0	10,5	8,0	21,0	200/100
1173M2025	M20x1,5	M25x1,5	29,0	10,0	8,0	21,0	100/50
1173M2532	M25x1,5	M32x1,5	36,0	11,5	8,0	23,0	50/50
1173M3240	M32x1,5	M40x1,5	46,0	11,5	10,0	25,0	50/50



Entry thread reducers

Metric thread M 1.5 pitch CEI EN 60423

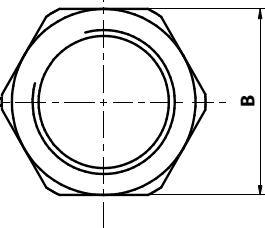
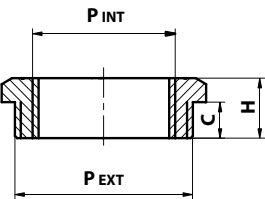

Type	P EXT	P INT	B Spanner (mm)	C (mm)	H (mm)	Quantity Box/Bag
1153M1612	M16x1,5	M12x1,5	22,0	8,0	12,0	300/100
1153M2012	M20x1,5	M12x1,5	24,0	8,0	12,0	300/100
1153M2016*	M20x1,5	M16x1,5	24,0	8,0	12,0	300/100
1153M2512	M25x1,5	M12x1,5	29,0	8,0	14,0	200/100
1153M2516	M25x1,5	M16x1,5	29,0	8,0	14,0	150/50
1153M2520*	M25x1,5	M20x1,5	29,0	8,0	14,0	150/50
1153M3216	M32x1,5	M16x1,5	36,0	10,0	16,0	100/50
1153M3220	M32x1,5	M20x1,5	36,0	10,0	16,0	100/50
1153M3225*	M32x1,5	M25x1,5	36,0	10,0	16,0	100/50
1153M4020	M40x1,5	M20x1,5	46,0	10,0	16,0	50/25
1153M4025	M40x1,5	M25x1,5	46,0	10,0	16,0	50/25
1153M4032	M40x1,5	M32x1,5	46,0	10,0	16,0	50/25
1153M5025	M50x1,5	M25x1,5	55,0	12,0	18,0	30/10
1153M5032	M50x1,5	M32x1,5	55,0	12,0	18,0	30/10
1153M5040	M50x1,5	M40x1,5	55,0	12,0	18,0	30/10
1153M6332	M63x1,5	M32x1,5	68,0	12,0	18,0	20/10
1153M6340	M63x1,5	M40x1,5	68,0	12,0	18,0	20/10
1153M6350	M63x1,5	M50x1,5	68,0	12,0	18,0	20/10

*Add to Ref: N for Black

ENTRY THREAD ADAPTERS

Nickel Plated Brass

2093
2043
20A4

Entry thread enlargers

Metric thread M 1.5 pitch CEI EN 60423

Type	P EXT	P INT	Ø A (mm)	C (mm)	H (mm)	Quantity Box/Bag
20931216N	M12x1,5	M16x1,5	18	5	15,5	500/100
20931620N	M16x1,5	M20x1,5	22	5	17,5	300/100
20932025N	M20x1,5	M25x1,5	27	6	20,0	150/50
20932532N	M25x1,5	M32x1,5	34	7	22,5	100/50
20932540N	M25x1,5	M40x1,5	42	7	23,5	50/50
20933240N	M32x1,5	M40x1,5	42	8	24,5	50/50
20933250N	M32x1,5	M50x1,5	52	8	27,5	25/25
20934050N	M40x1,5	M50x1,5	52	8	27,5	25/25
20935063N	M50x1,5	M63x1,5	66	9	31,0	20/10



Entry thread reducers

Metric thread M 1.5 pitch CEI EN 60423

Type	P EXT	P INT	Ø A (mm)	C (mm)	H (mm)	Quantity Box/Bag
20431612N	M16x1,5	M12x1,5	18	5	7,5	1.000/100
20432012N	M20x1,5	M12x1,5	22	6	9,0	600/100
20432016N	M20x1,5	M16x1,5	22	6	9,0	500/100
20432512N	M25x1,5	M12x1,5	27	7	10,0	300/50
20432516N	M25x1,5	M16x1,5	27	7	10,0	300/50
20432520N	M25x1,5	M20x1,5	27	7	10,0	300/100
20433220N	M32x1,5	M20x1,5	34	8	11,0	100/25
20433225N	M32x1,5	M25x1,5	34	8	11,0	150/50
20434025N	M40x1,5	M25x1,5	43	8	11,5	100/25
20434032N	M40x1,5	M32x1,5	43	8	11,5	100/25
20435032N	M50x1,5	M32x1,5	53	9	12,5	50/10
20435040N	M50x1,5	M40x1,5	53	9	12,5	50/25
20436340N	M63x1,5	M40x1,5	66	10	14,0	30/10
20436350N	M63x1,5	M50x1,5	66	10	14,0	30/10

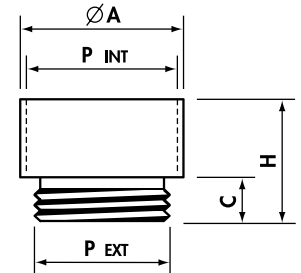

Fig. 1

Entry thread converters - Metric to Pg

Type	P EXT	P INT	Fig.	Ø A (mm)	C (mm)	H (mm)	Quantity Box/Bag
20A42011N	M20x1,5	Pg11	1	22	6,5	17,5	300/100
20A42016N	M20x1,5	Pg16	1	24	6,5	20,0	200/50
20A42513N	M25x1,5	Pg13,5	2	27	7,0	10,0	300/50
20A42516N	M25x1,5	Pg16	2	27	7,0	10,0	300/50
20A43216N	M32x1,5	Pg16	2	36	8,0	11,5	100/25
20A43221N	M32x1,5	Pg21	2	36	8,0	11,5	100/25

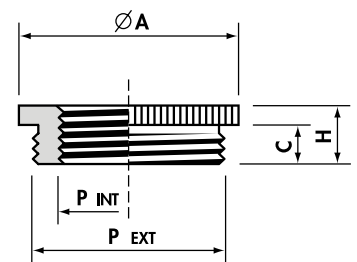

Fig. 2

Entry thread converters - Pg to Metric

20A40916N	Pg 9	M16x1,5	1	20	6,0	15,0	400/100
20A41120N	Pg11	M20x1,5	1	22	6,0	16,0	300/100
20A41320N	Pg13,5	M20x1,5	1	24	6,5	16,5	200/50
20A41620N	Pg16	M20x1,5	2	24	6,5	9,5	50/50
20A42120N	Pg21	M20x1,5	2	30	7,0	10,0	100/100
20A42125N	Pg21	M25x1,5	2	30	7,0	10,0	100/100
20A42925N	Pg29	M25x1,5	2	39	8,0	11,5	50/50

1800 2042

ENTRY THREAD ADAPTERS

Nickel Plated Brass

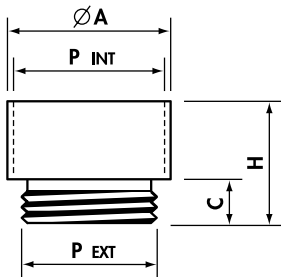

Entry thread enlargers

Pg thread DIN 40 430 - Dimensions DIN 46 320-K

Type	P EXT	P INT	Ø A (mm)	C (mm)	H (mm)	Quantity Box/Bag
180709	Pg 7	Pg 9	17	5,0	15,0	600/100
180911	Pg 9	Pg11	20	6,0	16,5	500/100
180913	Pg 9	Pg13,5	22	6,0	17,5	300/100
181113	Pg11	Pg13,5	22	6,0	17,5	300/100
181116	Pg11	Pg16	24	6,0	18,5	100/50
181316	Pg13,5	Pg16	24	6,5	19,0	200/50
181321	Pg13,5	Pg21	30	6,5	21,0	150/50
181621	Pg16	Pg21	30	6,5	21,0	100/25
182129	Pg21	Pg29	39	7,0	23,0	75/25
182936	Pg29	Pg36	50	8,0	27,5	30/10
183642	Pg36	Pg42	57	9,0	31,0	20/10
184248	pg42	pg48	64	10,0	33,0	20/10

Entry thread reducers

Pg thread DIN 40 430 - Dimensions DIN 46 320-H

Type	P EXT	P INT	Ø A (mm)	C (mm)	H (mm)	Quantity Box/Bag
20420907N	Pg 9	Pg 7	17	6,0	8,5	800/100
20421107N	Pg11	Pg 7	20	6,0	8,5	600/100
20421109N	Pg11	Pg 9	20	6,0	8,5	600/100
20421307N	Pg13,5	Pg 7	22	6,5	9,0	600/100
20421309N	Pg13,5	Pg 9	22	6,5	9,0	600/100
20421311N	Pg13,5	Pg11	22	6,5	9,0	600/100
20421607N	Pg16	Pg 7	24	6,5	9,5	300/50
20421609N	Pg16	Pg 9	24	6,5	9,5	400/100
20421611N	Pg16	Pg11	24	6,5	9,5	400/100
20421613N	Pg16	Pg13,5	24	6,5	9,5	400/100
20422111N	Pg21	Pg11	30	7,0	10,0	200/50
20422113N	Pg21	Pg13,5	30	7,0	10,0	200/50
20422116N	Pg21	Pg16	30	7,0	10,0	200/50
20422916N	Pg29	Pg16	39	8,0	11,5	100/25
20422921N	Pg29	Pg21	39	8,0	11,5	100/25
20423621N	Pg36	Pg21	50	9,0	12,5	50/25
20423629N	Pg36	Pg29	50	9,0	12,5	50/25
20424236N	Pg42	Pg36	57	10,0	14,0	50/25
20424836N	Pg48	Pg36	64	10,0	14,0	25/25
20424842N	Pg48	Pg42	64	10,0	14,0	50/25

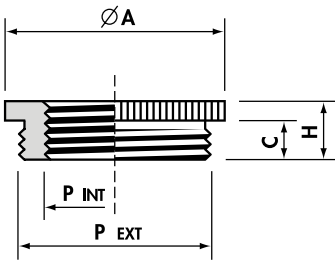



Compression washers

Type	Fits thread	Ø E (mm)	Ø I (mm)	Quantity Box/Bag
6010.14	Pg7 + G1/4"	11,0	8,0	15.000/1.000
6010.38	Pg9 + G3/8"	14,5	10,0	5.000/1.000
6010.11	Pg11 + G3/8"	17,0	12,0	5.000/1.000
6010.12	Pg13,5 + G1/2"	18,0	14,0	4.000/1.000
6010.58	Pg16 + G5/8"	20,0	15,5	3.000/1.000
6010.34	G3/4"	24,0	18,5	2.500/500
6010.114	G1"1/4	38,0	33,0	1.000/500
6010.21	Pg21 + G3/4"	26,5	20,0	2.000/500
6010.01	G1"	30,0	24,5	1.500/500
6010.29	Pg29 + G1"1/8	35,0	26,5	1.000/500
6010.36	Pg36 + G1"1/2	45,0	38,0	750/250
6010.42	Pg42	51,0	42,5	500/250
6010.48	Pg48 + G2"	57,0	48,0	400/100

Subject to availability, the compression washers could be of type A or B



Material:
Zinc plated STEEL UNI 5961/84

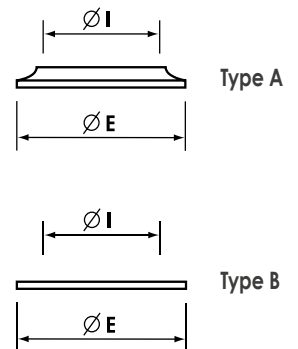

341
342
343
344



SEALING RINGS

PVC 50 sh A

PVC



Material: PVC 50 sh A
Colour: Red

Cylindrical sealing rings

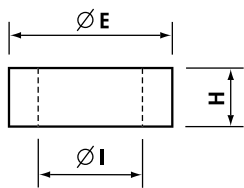

Type	Suitable for Cable Glands IP54 (1700..., 2001..., 2002..., 2003...)	C (mm)	Ø E (mm)	Ø I (mm)	H (mm)	Quantity Box/Bag
3411014	G1/4"	-	10,9	6,7	6,0	1.500/100
3411038	G3/8" + M16	-	14,5	8,5	6,0	1.000/100
3411012	Pg13,5 + G1/2" + M20	-	18,0	11,0	7,5	500/100
3412016	Pg16 + G5/8"	-	20,0	14,0	7,5	300/100
3422016	Pg16 + G5/8"	-	20,0	10,0	7,5	300/100
3411034	G3/4"	-	23,5	17,5	8,0	300/100
3411100	G1"	-	29,0	22,0	10	200/100
3412011	Pg11	-	16,5	10,0	7,0	1.000/100
3412021	Pg21 + M25	-	26,0	18,0	8,5	300/100
3412029	Pg29 + G1"1/8 + M32	-	35,0	26,0	10,0	200/100

Membrane sealing rings

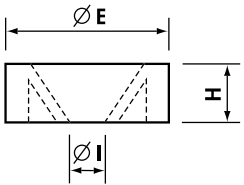

Type	Suitable for Cable Glands IP54 (1700..., 2001..., 2002..., 2003...)	C (mm)	Ø E (mm)	Ø I (mm)	H (mm)	Quantity Box/Bag
3431100	G1"	-	29	15	9,5	200/100

Double sealing rings

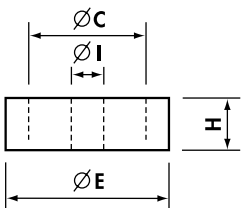

Type	Suitable for Cable Glands IP54 (2001..., 2002..., 2003...)	C (mm)	Ø E (mm)	Ø I (mm)	H (mm)	Quantity Box/Bag
3441012	G1/2" + Pg13,5 + M20	13	18,5	8	6,5	500/100
3441034	G3/4"	17	23	12,5	8,5	300/100

SEALING RINGS

Butadiene-Nitrile NBR

1880
1890



Concentric sealing rings

Type	Suitable for Cable Glands IP54 (1700..., 2001..., 2002..., 2003...)	Ø E (mm)	Ø 5 (mm)	Ø 4 (mm)	Ø 3 (mm)	Ø 2 (mm)	Ø 1 (mm)	Ø I (mm)	H (mm)	Quantity Box/Bag
1880	Pg9 + M16	13,3	-	-	-	10,0	7,5	5,0	5,5	1.500/100
1881	Pg11	16,5	-	-	-	12,5	10,0	7,5	6,0	1.000/100
1882	Pg13,5 + M20 + G1/2"	18,3	-	-	-	12,5	10,0	7,5	6,0	800/100
1883	Pg16 + G5/8"	20,4	-	-	15,0	12,5	10,0	7,5	7,0	600/100
1884	Pg21 + M25	26,0	-	-	19,0	16,0	13,0	10,0	8,0	300/100
1884A	Pg21 + M25	26,0	-	-	20,5	18,0	15,0	10,5	8,0	50/25
1885*	Pg29 + M32 + G1"1/8	34,7	-	-	27,0	24,0	21,0	18,0	9,5	150/50
1886	Pg36 + G1"1/2 + M40	44,7	-	-	33,0	30,0	27,0	24,0	12,0	100/50
1887*	Pg42 + M50	51,7	-	-	39,0	36,0	33,0	30,0	14,0	50/25
1888/5	Pg48 + G2" + M63	57,0	45	41	37,0	33,0	29,0	24,0	14,0	75/25
1888*	Pg48 + G2" + M63	57,0	-	-	45,0	42,0	39,0	36,0	14,0	50/25

*material: RUBBER NR



Material:
BUTADIENE-NITRILE NBR
with concentric perforations

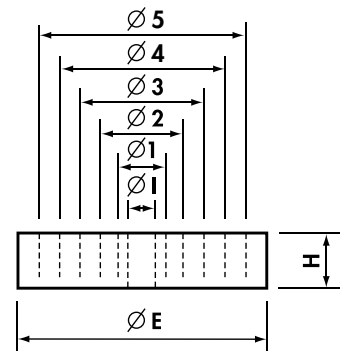

O-rings

Type	Fits thread	Ø E (mm)	Ø I (mm)	Ø H (mm)	Quantity Box/Bag
1889	M12	12,81	9,25	1,78	1.000/1.000
1890	Pg7 + G1/4"	14,38	10,82	1,78	5.000/1.000
1890A	M16 + Pg9 + G3/8"	15,98	12,42	1,78	5.000/1.000
1891	Pg11	19,16	15,60	1,78	5.000/1.000
1891A	M20	20,73	17,17	1,78	5.000/1.000
1892	Pg13,5 + G1/2"	22,33	18,77	1,78	5.000/1.000
1892A	Pg16 + G5/8"	23,91	20,35	1,78	5.000/1.000
1892B	M25	25,51	21,95	1,78	5.000/1.000
1893	Pg21	28,68	25,12	1,78	3.000/500
1893A	M32	30,00	26,00	2,00	500/500
1925.3	G3/4"	30,31	25,07	2,62	1.000/500
1894	G1"	35,06	29,82	2,62	1.000/500
1895	M40 + Pg29 + G1"1/8	39,84	34,60	2,62	1.000/500
1896	G1"1/4	43,01	37,77	2,62	500/500
1897	Pg36 + G1"1/2	49,36	44,12	2,62	800/100
1898	Pg42 + G1"3/4	55,71	50,47	2,62	800/100
1899	Pg48 + G2"	62,06	56,82	2,62	100
1899A	G2"1/2	76,50	69,44	3,53	100/1
1899B	G3"	92,60	81,92	5,34	100/1



Material:
Butadiene-Nitrile 70 sh

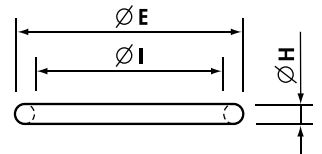

357

SEALING RINGS

Butadiene-Stirene SBR 70shA



Material:
BUTADIENE-STIRENE SBR 70 sh A
Temperature range: -20°C to +70°C
Colour: RAL 7035 light grey

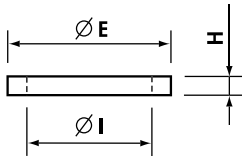

Type	Fits thread	Ø E (mm)	Ø I (mm)	H (mm)	Quantity Box/Bag
3572007	Pg7	16,5	11,5	1,0	4.000/100
3572011	Pg11	23,0	17,5	1,0	2.500/100
35720131	Pg13,5 + M20X1,5 + G1/2"	27,5	20,5	1,4	1.000/100
3572013	Pg13,5	30,0	20,5	2,2	1.000/100
3572016	Pg16	29,0	23,0	2,0	1.000/100
3572021	Pg21	33,5	27,0	3,0	500/100
3573M16	M16x1,5	20,5	16,3	1,0	3.000/100
3573M20	M20X1,5 + Pg13,5 + G1/2"	25,5	20,5	1,0	4.000/100
3573M25	M25x1,5	30,5	25,5	1,0	2.000/100
3573M32	M32x1,5	40,5	32,5	1,0	1.500/100

FD

SEALING RINGS

Neoprene® 80 sh A



Material:
NEOPRENE® 80 sh A
Temperature range: -25°C to +100°C
Colour: RAL 9005 black

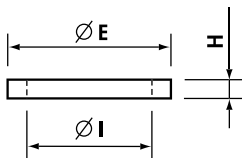

Type	Fits thread	Ø E (mm)	Ø I (mm)	H (mm)	Quantity Box/Bag
FD M12	M12	16,0	10,0	1,2	2.500/50
FD 7	Pg7 + G1/4"	17,0	11,3	1,2	3.000/50
FD 9	Pg9 + M16	20,0	13,9	1,2	2.000/50
FD M16	M16* + G3/8"	20,0	15,5	1,2	2.000/50
FD 11	Pg11	23,0	17,1	1,2	2.000/50
FD M20	M20	24,0	18,0	1,2	2.000/50
FD 13,5	Pg13,5 + G1/2"	25,0	19,0	1,2	2.500/50
FD 16	Pg16 + G5/8"	27,0	21,0	1,2	1.500/50
FD M25	M25	31,0	23,0	1,2	1.000/20
FD 21	Pg21 + G3/4"	34,5	27,0	1,5	1.000/25
FD M32	M32 + G1"	36,0	30,0	1,3	600/20
FD 29	Pg29 + G1"1/8"	45,0	35,2	1,5	500/25
FD M40	M40 + G1"1/4"	46,0	38,0	1,2	500/20
FD 36	Pg36 + G1"1/2"	53,5	45,6	1,2	250/25
FD M50	M50	55,0	47,5	1,1	10
FD 42	Pg42 + G1"3/4"	62,0	52,0	1,1	10
FD 48	Pg48 + G2"	68,0	58,0	1,1	10
FD M63	M63	68,0	59,0	1,1	500/5

*recommended with set screws

ENTRY PLUGS

Polyamide PA6

Metric thread M 1.5 pitch CEI EN 60423

Type Light Grey	P	Ø A (mm)	C (mm)	Quantity Box/Bag
1053M12	M12x1,5	15	6	100
1053M16	M16x1,5	20	6	100
1053M20	M20x1,5	25	7	100
1053M25	M25x1,5	30	7	100
1053M32	M32x1,5	37	9	50
1053M40	M40x1,5	47	9	30
1053M50	M50x1,5	58	10	20
1053M63	M63x1,5	72	12	10

Add to Ref: N for Black

Pg thread DIN 40 430 - Dimensions DIN 46 320

Type Light Grey	P	Ø A (mm)	C (mm)	Quantity Box/Bag
1052007	Pg 7	15	6	100
1052009	Pg 9	19	6	100
1052011	Pg11	22	7	100
1052013	Pg13,5	25	7	100
1052016	Pg16	27	7	100
1052021	Pg21	33	9	50
1052029	Pg29	44	9	100/50
1052036	Pg36	55	10	20
1052042	Pg42	62	10	10
1052048	Pg48	69	12	10

Add to Ref: N for Black

Polystyrene PS

Metric thread M 1.5 pitch CEI EN 60423

Type Light Grey	P	Ø A (mm)	C (mm)	Quantity Box/Bag
1253M12	M12x1,5	15	6	100
1253M16	M16x1,5	20	6	100
1253M20	M20x1,5	25	7	100
1253M25	M25x1,5	30	7	100
1253M32	M32x1,5	37	9	50
1253M40	M40x1,5	47	9	30
1253M50	M50x1,5	58	10	20
1253M63	M63x1,5	72	12	10

Add to Ref: N for Black

Pg thread DIN 40 430 - Dimensions DIN 46 320

Type Light Grey	P	Ø A (mm)	C (mm)	Quantity Box/Bag
1840	Pg 7	15	6	100
1841	Pg 9	19	6	100
1842	Pg11	22	7	100
1843	Pg13,5	25	7	100
1844	Pg16	27	7	100
1845	Pg21	33	9	50
1846	Pg29	44	9	100/50
1847	Pg36	55	10	20
1848	Pg42	62	10	10
1849	Pg48	69	12	10

Add to Ref: N for Black

1053
1052



Material: POLYAMIDE PA6 reinforced with fibreglass self-extinguishing class HB (UL 94)
Temperature range: -20°C to +90°C (continuous)
Protection: IP 54
Colour: RAL 7035 light grey, RAL 9005 black

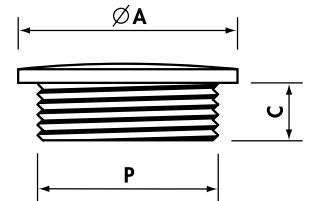

1253
1840



Material: POLYSTYRENE PS
Temperature range: -20°C to +60°C (continuous)
Protection: IP 54
Colour: RAL 7035 light grey, RAL 9005 black

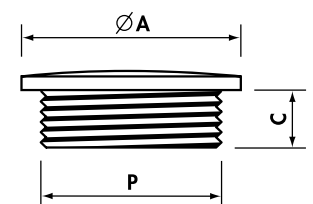



**

Material: POLIAMMIDE PA6 / PA6.6**
 self-extinguishing class V0 / V2** (UL 94)
 Temperature range:
 -20°C to +90°C (continuous)
 Colour: RAL 7035 light grey,
 RAL 9005 black

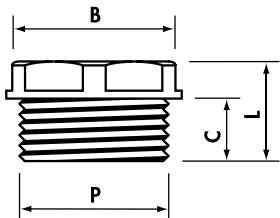
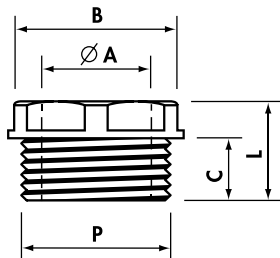

Entry bushes

Pg thread DIN 40 430 - Dimensions DIN 46 320

Type Light Grey	P	Ø A (mm)	B Spanner (mm)	C (mm)	L min-max (mm)	Quantity Box/Bag
*1700.2	Pg 9	10,0	16	9,0	14,0	600/100
*1701.2	Pg11	11,5	19	10,0	15,0	300/100
*1702.2**	Pg13,5	13,5	21	11,0	16,5	300/100
1703.2	Pg16	16,0	23	12,5	18,5	200/50
1704.2	Pg21	22,0	30	12,0	17,5	100/50
1705.2	Pg29	27,0	40	15,0	22,0	50/50

BSP thread ISO 228/1

Type Light Grey	P	Ø A (mm)	B Spanner (mm)	C (mm)	L min-max (mm)	Quantity Box/Bag
*1830	G1/4"	8,5	15	8,5	13,5	800/100
*1831	G3/8"	11,5	17	9,0	14,0	300/100
*1832**	G1/2"	13,0	21	11,0	16,5	300/100

Metric thread M 1.5 pitch CEI EN 60423

Type Light Grey	P	Ø A (mm)	B Spanner (mm)	C (mm)	L min-max (mm)	Quantity Box/Bag
1835	M16x1,5	11,5	17	9	14,0	400/100
*1836**	M20x1,5	13,5	21	11	16,5	300/100

*Add to Ref: N for Black

Blind entry bushes

Pg thread DIN 40 430 - Dimensions DIN 46 320

Type Light Grey	P	Ø A (mm)	B Spanner (mm)	C (mm)	L min-max (mm)	Quantity Box/Bag
*1702.5**	Pg13,5	-	21	11,0	17,0	300/100
1703.5	Pg16	-	23	12,5	18,5	200/100

BSP thread ISO 228/1

Type Light Grey	P	Ø A (mm)	B Spanner (mm)	C (mm)	L min-max (mm)	Quantity Box/Bag
*1861	G3/8"	-	17	9	14	600/100
*1862**	G1/2"	-	21	11	16,5	200/100

Metric thread M 1.5 pitch CEI EN 60423

Type Light Grey	P	Ø A (mm)	B Spanner (mm)	C (mm)	L min-max (mm)	Quantity Box/Bag
*1866**	M20x1,5	-	21	11	17	100

*Add to Ref: N for Black

ENTRY PLUGS

Nickel Plated Brass

Metric thread M 1.5 pitch CEI EN 60423

Type Nickel Plated Brass	P	Ø A (mm)	C (mm)	Quantity Box/Bag
2053M12N	M12x1,5	14	5,0	1.500/100
2053M16N	M16x1,5	18	5,0	1.000/100
2053M20N	M20x1,5	22	6,5	500/100
2053M25N	M25x1,5	28	7,0	200/100
2053M32N	M32x1,5	35	8,0	150/25
2053M40N	M40x1,5	44	8,5	100/25
2053M50N	M50x1,5	54	9,0	50/25
2053M63N	M63x1,5	67	10,0	25/25

Pg thread DIN 40 430 - Dimensions DIN 46 320

Type Nickel Plated Brass	P	Ø A (mm)	C (mm)	Quantity Box/Bag
2052007N	Pg 7	14	5,0	1.500/100
2052009N	Pg 9	17	6,0	1.000/100
2052011N	Pg11	20	6,0	500/100
2052013N	Pg13,5	22	6,5	500/100
2052016N	Pg16	24	6,5	500/100
2052021N	Pg21	30	7,0	200/50
2052029N	Pg29	39	8,0	100/25
2052036N	Pg36	50	9,0	50/25
2052042N	Pg42	57	10,0	25/25
2052048N	Pg48	64	10,0	25/25

ENTRY BUSHES

Brass

BSP thread ISO 228/1

Type Brass	P	Ø A (mm)	B Spanner (mm)	C (mm)	L min-max (mm)	Quantity Box/Bag
2021014	G1/4"	10,0	13	6,0	8,5	1.000/100
2021038	G3/8"	12,0	17	7,5	10,5	800/100
2021012	G1/2"	16,0	21	9,5	13,0	400/100
2021058	G5/8"	18,0	23	10,0	13,5	250/50
2021034	G3/4"	21,0	27	10,0	14,0	200/50
2021100	G1"	26,5	34	11,0	15,5	100/50
2021118	G1"1/8	31,0	38	12,0	16,5	100/25
2021114	G1"1/4	35,0	42	13,0	18,0	50/25
2021112	G1"1/2	41,5	48	13,0	18,5	50/25
2021200	G2"	51,5	60	13,5	19,5	25/25

Add to Ref: N for NICKEL PLATED BRASS

2053
2052



Material: NICKEL PLATED BRASS
(CuZn 40 Pb 3)
Protection: IP 54

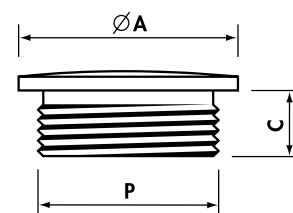

2021



Material: PLAIN BRASS

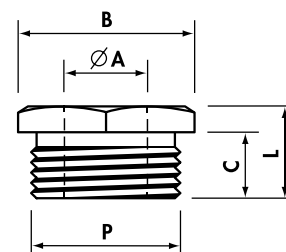

RS

RUTASEAL GROMMETS

Rubber EPDM



HF
HALOGEN
FREE



Material: Rubber EPDM halogen-free and chemical resistant
 Temperature range: -40°C to +110°C
 Protection: IP 67
 Colour: RAL 7001 light grey
 Application: IP67 sealing of cables and conduits in Metric and Pg threaded entries through material thickness 0,5-4 mm

Fits Metric thread

Type	Fits Threaded Entry	A (mm)	B (mm)	C (mm)	D (mm)	E (mm)	Quantity Box/Bag
RS0407.M12	M12	12,5	0,5-2	5,6	20,0	4-7	4000/50
RS0509.M16	M16	16,5	1-4	11,0	21,0	5-9	4000/50
RS0813.M20	M20/Pg13,5	20,5	1-4	13,4	25,5	8-13	2000/50
RS1117.M25	M25	25,5	1-4	15,3	30,5	11-17	1500/50
RS1520.M32	M32	32,5	1-4	18,6	38,5	15-20	1000/25
RS1928.M40	M40	40,5	1-4	21,7	48,5	19-28	400/25
RS2735.M50	M50	50,5	1-4	25,0	60,5	27-35	250/10

Fits Pg thread

Type	Fits Threaded Entry	A (mm)	B (mm)	C (mm)	D (mm)	E (mm)	Quantity Box/Bag
RS0305.07	Pg 7	12,5	0,5-2	5,4	20,0	3-5	4000/50
RS0507.09	Pg 9	16,0	1-4	10,3	21,0	5-7	4000/50
RS0710.11	Pg11	19,0	1-4	12,7	24,0	7-10	2000/50
RS1014.16	Pg16	23,0	1-4	14,7	28,0	10-14	1500/50
RS1420.21	Pg21	29,0	1-4	17,6	35,0	14-20	1000/25
RS2026.29	Pg29	38,0	1-4	20,0	46,0	20-26	400/25
RS2635.36	Pg36	48,0	1-4	23,9	58,0	26-35	250/10

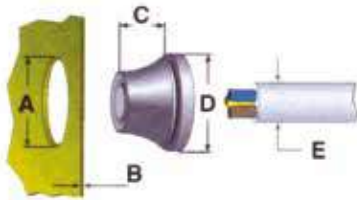

3600

MODULAR RETAINING CLIPS

ABS



SICUR® clips

Application: Fix SICURclip base to surface using dia. 5 - 6 mm screw (Ref. Fig. A). Insert cable, tubing or flexible conduit. Fit adjustable cover and press to secure. Modular SICURclips of the same or different size may easily be joined together.

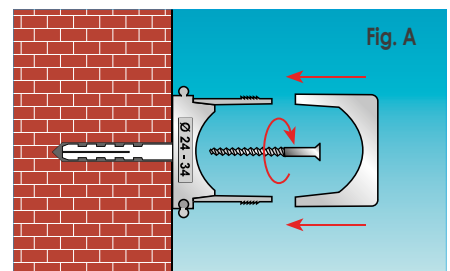

Material: ABS self-extinguishing class V0 (UL94) UV stabilised
 Glow wire resistance: 750° C (CEI EN 60695-2-1)
 Temperature range: -20°C to +80°C (continuous)
 Colour: RAL 7035 light grey

Type	Ø A min-max (mm)	H (mm)	S (mm)	Quantity
3601	13-21	8,5	16	100
3602	24-34	8,5	16	50
3603	38-50	8,5	16	25

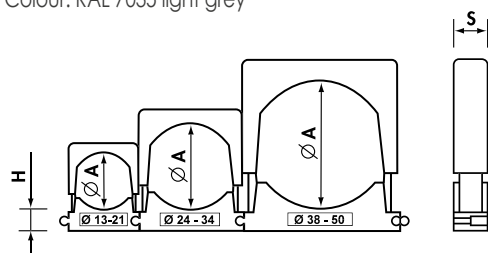

MECHANICAL AND PNEUMATIC TOOLS



symbol description

professional mechanical tools - hydraulic bench press



Can be operated with one hand



Max cutting diameter



Manual pressure release button



High hardness blades



Ergonomically designed with a sculptured body for operator comfort



Stainless steel blades



Lightweight and balanced for greater control



High tensile steel blades



Dual-compound plastic handles
Greater safety and comfort in handling, thanks to the rubber inserts



Micro-serrated blades for anti-slip purpose



Durable moulded body offering high resistance to wear and damage in all operating conditions



Special Steel frame for high resistance and a long life



Extremely quiet in operation



Protected against accidental intrusions



Max cutting section

symbol description

professional mechanical tools - hydraulic bench press



Hexagonal crimp



Radial crimp



Indent crimp



Indent crimp



Oval crimp



Trapezium crimp



Rhomboidal crimp



Square crimp



CE marking



UKCA marking



CRIMPSTAR®

Manual tool, compact and easy to use, equipped with:

- treated steel crimp jaws with high mechanical properties.
- factory-set ratchet for crimping control (automatic handle opening upon completion of crimping operation).
- Emergency release lever which, if necessary, opens the crimp jaws before their complete closure.
- Ergonomically designed non-slip moulded plastic grips.

HP1

MECHANICAL TOOLS CRIMPSTAR® RANGE

for insulated terminals and connectors



Crimpstar®



TECHNICAL FEATURES:

Crimping Range	PVC, PC and PA6.6 insulated terminals and connectors for conductor sizes 0,2 to 2,5 sqmm
Dimensions mm	
Length	235
Width	78
Height	19
Weight g	512
Package Dimensions	240 x 81 x 25

HP3

MECHANICAL TOOLS CRIMPSTAR® RANGE

for insulated terminals and connectors



Crimpstar®



TECHNICAL FEATURES

Crimping Range	PVC, PC and PA6.6 insulated terminals and connectors for conductor sizes 0,25 to 6 sqmm
Dimensions mm	
Length	235
Width	78
Height	19
Weight g	498
Package Dimensions	240 x 81 x 25

MECHANICAL TOOLS CRIMPSTAR® RANGE

HNN3

for insulated terminals and connectors

Crimpstar®



TECHNICAL FEATURES

Crimping Range	PA6.6 insulated terminals and connectors for conductor sizes 1,5 to 10 sqmm
Dimensions mm	
Length	235
Width	78
Height	19
Weight g	491
Package Dimensions	240 x 81 x 25



MECHANICAL TOOLS CRIMPSTAR® RANGE

HNN4

for insulated terminals and connectors

Crimpstar®



TECHNICAL FEATURES

Crimping Range	PA6.6 insulated terminals and connectors for conductor sizes 10 and 16 sqmm
Dimensions mm	
Length	235
Width	78
Height	19
Weight g	492
Package Dimensions	240 x 81 x 25



HPH1

MECHANICAL TOOLS CRIMPSTAR® RANGE

for through connectors PE HD insulated, heat shrinkable



Crimpstar®



TECHNICAL FEATURES

Crimping Range	Through connectors PE HD insulated, heat shrinkable. for conductor sizes 0,5 to 6 sqmm and PA6.6 connectors NL-M, NL-P for conductor sizes 0,25 to 6 sqmm
Dimensions mm	
Length	235
Width	78
Height	19
Weight g	512
Package Dimensions	240 x 81 x 25

HNKE4

MECHANICAL TOOLS CRIMPSTAR® RANGE

for end sleeves



Crimpstar®



TECHNICAL FEATURES

Crimping Range	End sleeves for conductor sizes 0,5 to 4 sqmm
Dimensions mm	
Length	235
Width	78
Height	19
Weight g	498
Package Dimensions	240 x 81 x 25

MECHANICAL TOOLS CRIMPSTAR® RANGE

HNKE16

for end sleeves

Crimpstar®



TECHNICAL FEATURES

Crimping Range	End sleeves for conductor sizes 4 to 16 sqmm
Dimensions mm	
Length	235
Width	78
Height	19
Weight g	491
Package Dimensions	240 x 81 x 25



MECHANICAL TOOLS CRIMPSTAR® RANGE

HNKE50

for end sleeves

Crimpstar®



TECHNICAL FEATURES

Crimping Range	End sleeves for conductor sizes 25 - 35 - 50 sqmm
Dimensions mm	
Length	235
Width	78
Height	19
Weight g	590
Package Dimensions	240 x 81 x 25



HN1

MECHANICAL TOOLS CRIMPSTAR® RANGE

for uninsulated terminals and connectors



Crimpstar®

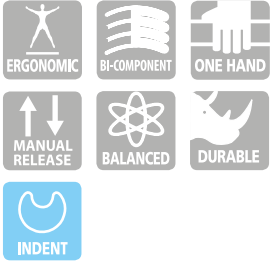

TECHNICAL FEATURES

Crimping Range	Uninsulated terminals and connectors for conductor sizes 0,25 to 10 sqmm
Dimensions mm	
Length	235
Width	78
Height	19
Weight g	480
Package Dimensions	240 x 81 x 25

HN5

MECHANICAL TOOLS CRIMPSTAR® RANGE

for uninsulated terminals and connectors



Crimpstar®



TECHNICAL FEATURES

Crimping Range	Uninsulated terminals and connectors for conductor sizes 10 and 16 sqmm
Dimensions mm	
Length	235
Width	78
Height	19
Weight g	489
Package Dimensions	240 x 81 x 25

MECHANICAL TOOLS CRIMPSTAR® RANGE

HN-A25

for uninsulated terminals and connectors A-M, L-M and L-P series

Crimpstar®



HN-D25

for Cu tube lugs DR (DIN 46235) and through connectors DSV (DIN 46267)

Crimpstar®



HN-H25

for Cu tube lugs HR and through connectors HSV

Crimpstar®



HN-T25

for Cu tube lugs T-M, T-L and through connectors L-T

Crimpstar®



HN-A25 TECHNICAL FEATURES:

Crimping Range

Uninsulated terminals and connectors A-M, L-M and L-P series
for conductor sizes 10 to 25 sqmm

HN-D25 TECHNICAL FEATURES:

Crimping Range

Cu tube lugs DR (DIN 46235) and through connectors DSV (DIN 46267)
for conductor sizes 10 to 25 sqmm

HN-H25 TECHNICAL FEATURES:

Crimping Range

Cu tube lugs HR and through connectors HSV
for conductor sizes 10 to 25 sqmm

HN-T25 TECHNICAL FEATURES:

Crimping Range

Cu tube lugs T-M, T-L and through connectors L-T
for conductor sizes 10 to 25 sqmm



Dimensions mm

Length	230
Width	78
Height	19
Weight g	500
Package Dimensions	240 x 81 x 25

HF1

MECHANICAL TOOLS CRIMPSTAR® RANGE

for open barrel brass terminals



Crimpstar®



TECHNICAL FEATURES

Crimping Range	Open barrel brass terminals for conductors sizes 0,5 to 4 sqmm (not BN-FAB/FAR type)
Dimensions mm	
Length	235
Width	78
Height	19
Weight g	509
Package Dimensions	240 x 81 x 25

HF2

MECHANICAL TOOLS CRIMPSTAR® RANGE

for open barrel brass terminals



Crimpstar®



TECHNICAL FEATURES

Crimping Range	Open barrel brass terminals for conductors sizes 0,08 to 1,3 sqmm (28 to 16 AWG)
Dimensions mm	
Length	235
Width	78
Height	19
Weight g	497
Package Dimensions	240 x 81 x 25

MECHANICAL TOOLS CRIMPSTAR® RANGE

HX1

for coaxial connectors

Crimpstar®



TECHNICAL FEATURES

Crimping Range	Coaxial connectors type RG58, RG59, RG62 and RG 71
Dimensions mm	
Length	235
Width	78
Height	19
Weight g	481
Package Dimensions	240 x 81 x 25



ND

MECHANICAL TOOLS ND® RANGE

for insulated and uninsulated end sleeves



A generation of tools, with a unique mechanism to reduce operator effort. Small and compact, with ergonomically designed handles for ease of operation.

High quality materials combined with advanced design and manufacturing technology, produce a reliable tool with a guaranteed consistent, crimping operation.



ND1



TECHNICAL FEATURES

Crimping Range	Insulated and uninsulated end sleeves for conductors sizes 0,3 to 1,5 sqmm
Dimensions mm	
Length	190
Width	72
Height	21
Weight g	470



ND2



TECHNICAL FEATURES

Crimping Range	Insulated and uninsulated end sleeves for conductors sizes 1 to 6 sqmm
Dimensions mm	
Length	190
Width	72
Height	21
Weight g	470



ND3



TECHNICAL FEATURES

Crimping Range	Insulated and uninsulated end sleeves for conductors sizes 6 to 16 sqmm
Dimensions mm	
Length	190
Width	72
Height	21
Weight g	470



ND4



TECHNICAL FEATURES

Crimping Range	Insulated and uninsulated end sleeves for conductors sizes 0,5 to 4 sqmm
Dimensions mm	
Length	190
Width	72
Height	21
Weight g	470



Package Dimensions mm	195 x 76 x 20
------------------------------	---------------

MECHANICAL TOOLS ZKE RANGE

for insulated and uninsulated end sleeves

ZKE



TECHNICAL FEATURES

Crimping Range	Single aperture, ratchet controlled tool for crimping end sleeves, 0,08 to 10 sqmm side insertion
Dimensions mm	
Length	180
Width	78
Height	20
Weight g	404



ZKE610



TECHNICAL FEATURES

Crimping Range	Single aperture, ratchet controlled tool for crimping end sleeves, 0,08 to 16 sqmm side insertion
Dimensions mm	
Length	178
Width	74
Height	30
Weight g	422



ZKE616



TECHNICAL FEATURES

Crimping Range	Tool for crimping end sleeves 0,5 to 6 sqmm front insertion
Dimensions mm	
Length	200
Width	80
Height	20
Weight g	372



ZKE6-F



TECHNICAL FEATURES

Crimping Range	For end sleeves 0,5 to 16 sqmm
Dimensions mm	
Length	190
Width	62
Height	11
Weight g	240



ZKE2

HP4-R

MECHANICAL TOOLS HP4 RANGE

for insulated terminals and connectors



TECHNICAL FEATURES

Crimping Range	PVC, PC and PA6.6 insulated terminals and connectors for conductor sizes 0,25 to 1,5 sqmm
Dimensions mm	
Length	265
Width	80
Height	24
Weight g	500
Package Dimensions	330 x 110 x 50 mm

Professional manual mechanical tool with ratchet mechanism that prevents the handles from opening again before reaching the ratchet. Equipped with a positioning device to reduce the operator's effort and facilitate proper crimping of the conductor.

According to the different thicknesses of the conductor insulation, the crimping on the insulation can be carried out by adjusting the jaws through three different settings:

1) strong, 2) medium, 3) light. The tool is particularly easy to use thanks to its shape and handle

coating. At the end of the crimping the outer surface of the conductor is automatically stamped with the following crimping code: one point for red conductor sizes from 0.25 to 1.5 mm²

Construction features:

- Special treated and externally protected steel body, ratchet and handles.
- Handle coating in soft red PVC plastic.

HP4-B

MECHANICAL TOOLS HP4 RANGE

for insulated terminals and connectors



TECHNICAL FEATURES

Crimping Range	PVC, PC and PA6.6 insulated terminals and connectors for conductor sizes 1,5 to 2,5 sqmm
Dimensions mm	
Length	265
Width	80
Height	24
Weight g	500
Package Dimensions	330 x 110 x 50 mm

Professional manual mechanical tool with ratchet mechanism that prevents the handles from opening again before reaching the ratchet. Equipped with a positioning device to reduce the operator's effort and facilitate proper crimping of the conductor.

According to the different thicknesses of the conductor insulation, the crimping on the insulation can be carried out by adjusting the jaws through three different settings:

1) strong, 2) medium, 3) light. The tool is particularly easy to use thanks to its shape and handle

coating. At the end of the crimping the outer surface of the conductor is automatically stamped with the following crimping code: two points for blue conductor sizes from 1.5 to 2.5 mm²

Construction features:

- Special treated and externally protected steel body, ratchet and handles.
- Handle coating in soft blue PVC plastic.

MECHANICAL TOOLS HP4 RANGE

for insulated terminals and connectors

HP4-G



TECHNICAL FEATURES

Crimping Range	PVC, PC and PA6.6 insulated terminals and connectors for conductor sizes 4 to 6 sqmm
Dimensions mm	
Length	320
Width	105
Height	25
Weight g	810
Package Dimensions	330 x 110 x 50 mm

Professional manual mechanical tool with ratchet mechanism that prevents the handles from opening again before reaching the ratchet. Equipped with a positioning device to reduce the operator's effort and facilitate proper crimping of the conductor.

According to the different thicknesses of the conductor insulation, the crimping on the insulation can be carried out by adjusting the jaws through three different settings:

1) strong, 2) medium, 3) light. The tool is particularly easy to use thanks to its shape and handle coating.



Construction features:

- Special treated and externally protected steel body, ratchet and handles.
- Handle coating in soft yellow PVC plastic.

MECHANICAL TOOLS HP4 RANGE

for sleeve connectors

HP4-C10



TECHNICAL FEATURES

Crimping Range	For sleeve connectors type C6-C6 and C10-C10
Dimensions mm	
Length	325
Width	105
Height	21
Weight g	730
Package Dimensions	330 x 110 x 50 mm



Professional manual mechanical tool with ratchet mechanism that prevents the handles from opening again before reaching the ratchet. The tool is particularly easy to use thanks to its shape and handle coating.

Construction features:

- Special treated and externally protected steel body, ratchet and handles.
- Handle coating in soft yellow PVC plastic.

HWE1

MECHANICAL TOOL HWE1

with interchangeable dies

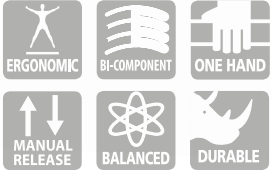

A robust and reliable tool designed to optimise the installers time and effort.

A single tool body with a range of interchangeable dies allows a quick and simple transfer from one cable/connector combination to another, across a range of applications.

TECHNICAL FEATURES:

- Automatic opening of handles following completion of the crimping operation
- Dull Nickel finish
- Anti-slip handle grips

TECHNICAL FEATURES

Dimensions mm

Length	240
Width	79
Height	32,5
Weight g	590



KIT-HWE1

comprising:

- HWE1 Manual mechanical tool
- WF16 die
- IT6 die
- all contained in a sturdy plastic case with extra compartments for interchangeable dies



INTERCHANGEABLE DIES INCLUDED IN THE KIT

INSULATED AND UNINSULATED END SLEEVES

WF16

Size 0,5 ÷ 16 sqmm

INSULATED CONNECTORS RED, BLUE AND YELLOW

IT6

Size 0,5 ÷ 6 sqmm

INTERCHANGEABLE DIES TO ORDER SEPARATELY

PHOTOVOLTAIC CONNECTORS (MULTI-CONTACT)

MC3

Size 4 ÷ 6 sqmm

MC4

Size 4 ÷ 6 sqmm



INSULATED AND UNINSULATED END SLEEVES

WF6

Size 0,5 ÷ 6 sqmm

WF35

Size 16 ÷ 35 sqmm

UNINSULATED CABLE LUGS

NIT10

Size 0,5 ÷ 10 sqmm

OPEN BARREL BRASS CONNECTORS

OB2.5P

Size 0,5 and 2,5 sqmm

SUB-D075

Size 0,05 and 0,75 sqmm

SUB-D050

Size 0,08 and 0,5 sqmm

COAXIAL CONNECTORS

C59

RG58, RG59, RG62

MLRJ1

MECHANICAL TOOL MLRJ1

MARKETline range



TECHNICAL FEATURES

Crimping Range

For crimping plugs RJ 11; RJ 12; RJ 14; RJ 22; RJ 45.
With cutting and wire-stripping blades

Dimensions mm

Length	211
Width	75
Height	23
Weight g	526



MECHANICAL TOOL IDT

with modular interchangeable dies

Dies for photovoltaic connectors



4300-3541
Tyco Solarlok

4300-3539
MC4 Multi Contact

4300-3540
MC3 Multi Contact

See page 147 for HB11 cable stripper



TECHNICAL FEATURES

Dimensions mm

Length	234
Width	64
Height	24
Weight g	460

INTERCHANGEABLE DIES TO ORDER SEPARATELY

INSULATED CONNECTORS RED, BLUE, YELLOW and GREEN

4300-3129 Size 0,5 ÷ 2,5 mm ² (Red - Blue)	4300-3128 Size 4 ÷ 6 mm ² (Yellow) Size 0,1 ÷ 0,4 mm ² (Green)
--	---

CONNECTORS WITH HEAT SHRINKABLE INSULATION

4300-3258 Size 0,5 ÷ 2,5 mm ² (Red - Blue)	4300-3262 Size 4 ÷ 6 mm ² (Yellow) Size 0,32 ÷ 0,75 mm ² (Green)
--	---

UNINSULATED CONNECTORS

4300-3137 Size 0,75 ÷ 2,5 mm ²	4300-3241 Size 4 ÷ 10 mm ²
---	---

CONTACTS FOR MULTI POLAR CONNECTORS (eg. ILME, HTS, CONTACT)

4300-3147 Size 0,14 ÷ 4 mm ²	4300-3148 Size 6 ÷ 10 mm ²
---	---

INSULATED AND UNINSULATED END SLEEVES

4300-3127 Size 0,25 ÷ 10 mm ²	4300-3153 Size 16 ÷ 25 mm ²	4300-3154 Size 35 ÷ 50 mm ²
--	--	--

OPEN BARREL CONNECTORS

4300-3146 Size 0,5 ÷ 6 mm ²
--

BNC/TNC CONNECTORS FOR COAXIAL CABLES

4300-3136 RG 58, 59, 62, 71	4300-3140 RG 174, 179
---------------------------------------	---------------------------------

TV - SATELLITE RECEIVER CONNECTORS

4300-3138 RG 6, 59

PHONE CONNECTORS

4300-3144 RJ 45 (LARGE)	4300-3132 RJ 11 (SMALL)
-----------------------------------	-----------------------------------

PHOTOVOLTAIC CONNECTORS (MULTI-CONTACT)

4300-3540 MC3 Size 2,5 - 4/6 mm ²	4300-3539 MC4 Size 2,5/4/6 mm ²	4300-3541 Tyco Solarlok Size 2,5/4/6 mm ²
---	---	---



A robust and reliable tool designed to optimise the installers time and effort.

A single tool body with a range of interchangeable dies allows a quick and simple transfer from one cable/connector combination to another, across a wide range of applications.

Modular dies may be inserted/extracted without using any tools and are connected in pairs for speed and convenience.

To assist correct die selection, the type of connector is illustrated on each die.

Each die also carries an illustration of the steps in each crimping process, to assist in achieving the best result.



VALSTAR R3 IDT

To order separately - sturdy plastic case designed to store an IDT tool and up to 10 modular dies.

Modular die storage housings are easily combined for convenient transportation



Modular die pack

TN70SE TN70

MECHANICAL TOOLS TN RANGE

for uninsulated terminals and connectors

A-M
SERIES



Professional manual mechanical tool suitable for crimping A-M Cu lugs and non-insulated L-M and L-P connectors.

Heat treated steel crimp jaws.

Easily adjustable die positioning by knurled screw and reference vernier scale.

Handles made from anti-slip plastic with hilt.



TN70SE: vernier scale with section of conductors

TN70: vernier scale with connector sizes

TECHNICAL FEATURES

Crimping Range

*Uninsulated terminals and connectors
for conductor sizes 6 R/F to 70 R/F sqmm

Dimensions mm

Length

450

Width

127

Height

47

Weight kg

2

*R= Rigid conductor F= Flexible conductor



TNN70

MECHANICAL TOOLS TN RANGE

for insulated terminals and connectors

ANE
SERIES



Professional manual mechanical tool suitable for the crimping of wire terminals and PA 6.6 insulated connectors.

Heat treated steel crimp jaws.

Easily adjustable die positioning by knurled screw and reference vernier scale.

Handles made from anti-slip plastic with hilt.



TECHNICAL FEATURES

Crimping Range

*Polyamide PA6.6 insulated terminals and connectors
for conductor sizes 10 F to 70 F sqmm

Dimensions mm

Length

450

Width

127

Height

47

Weight kg

2

*F= Flexible conductor



MECHANICAL TOOLS TN RANGE

for uninsulated terminals and connectors

TN120SE TN120S

A-M
SERIES



TECHNICAL FEATURES

Crimping Range	*Uninsulated terminals and connectors for conductor sizes 10 R/F to 120 R/150 F sqmm	
Dimensions mm		
Length	700	
Width	170	
Height	47	
Weight kg	3	

*R= Rigid conductor F= Flexible conductor



Professional manual mechanical tool suitable for crimping A-M Cu lugs and non-insulated L-M and L-P connectors. Heat treated steel crimp jaws. Easily adjustable die positioning by knurled screw and reference vernier scale. Handles made from anti-slip plastic with hilt.

TN120SE: vernier scale with section of conductors
TN120S: vernier scale with connector sizes

MECHANICAL TOOLS TN RANGE

for insulated terminals and connectors

TNN120

ANE
SERIES

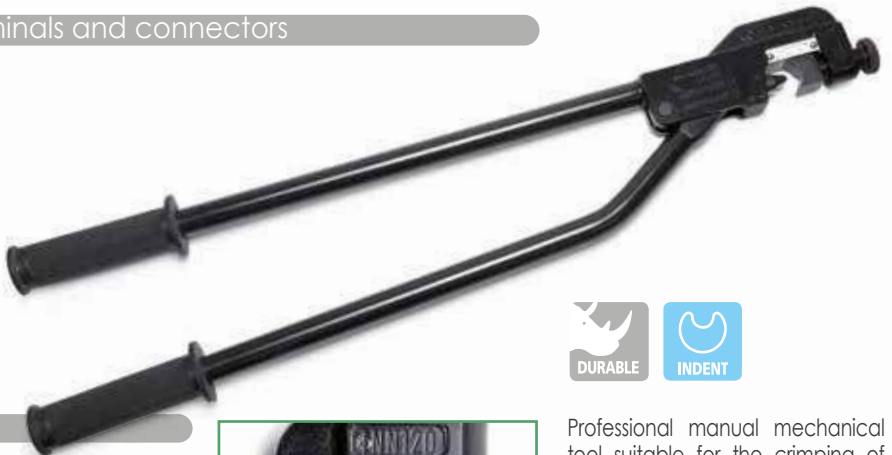

TECHNICAL FEATURES

Crimping Range	*Polyamide PA6.6 insulated terminals and connectors for conductor sizes 10 F to 120 F sqmm	
Dimensions mm		
Length	700	
Width	170	
Height	47	
Weight kg	3	

*F= Flexible conductor



Professional manual mechanical tool suitable for the crimping of wire terminals and PA 6.6 insulated connectors. Heat treated steel crimp jaws. Easily adjustable die positioning by knurled screw and reference vernier scale. Handles made from anti-slip plastic with hilt.

TND6-70

MECHANICAL TOOLS TND RANGE

for uninsulated terminals and connectors according to DIN 46235 and DIN 46267 T.1



DR
SERIES



Mechanical tools equipped with rotating dies with hexagonal imprint compliant with DIN 480863 suitable to crimp Copper lugs according to DIN 46235 and through connectors according to DIN 46267 T.1 (refer to page 44-45), particularly sturdy and easy to handle.



TECHNICAL FEATURES

Crimping Range

Uninsulated terminals and connectors according to DIN 46235 and DIN 46267 T.1 for conductor sizes 6 to 70 sqmm

Dimensions mm

Length	515
Width	132
Height	46
Weight kg	2



TND10-120

MECHANICAL TOOLS TND RANGE

for uninsulated terminals and connectors according to DIN 46235 and DIN 46267 T.1



DR
SERIES



Mechanical tools equipped with rotating dies with hexagonal imprint compliant with DIN 480863 suitable to crimp Copper lugs according to DIN 46235 and through connectors according to DIN 46267 T.1 (refer to page 44-45), particularly sturdy and easy to handle.



TECHNICAL FEATURES

Crimping Range

Uninsulated terminals and connectors according to DIN 46235 and DIN 46267 T.1 for conductor sizes 10 to 120 mm²

Dimensions mm

Length	665
Width	162
Height	52
Weight kg	3,7



MECHANICAL TOOLS TNH RANGE

TNH6-70

for uninsulated copper tube lugs HR and through connectors HSV

HR
SERIES



TECHNICAL FEATURES

Crimping Range	for uninsulated Copper tube lugs HR and through connectors HSV for conductor sizes 6 to 70 sqmm
Dimensions mm	
Length	515
Width	132
Height	46
Weight kg	2



Mechanical tools equipped with rotating dies with hexagonal imprint suitable to crimp Copper tube lugs HR and through connectors HSV (refer to page 46-47), particularly sturdy and easy to handle.

MECHANICAL TOOLS TNH RANGE

TNH10-120

for uninsulated copper tube lugs HR and through connectors HSV

HR
SERIES



TECHNICAL FEATURES

Crimping Range	for uninsulated Copper tube lugs HR and through connectors HSV for conductor sizes 10 to 120 mm ²
Dimensions mm	
Length	665
Width	162
Height	52
Weight kg	3,7



Mechanical tools equipped with rotating dies with hexagonal imprint suitable to crimp Copper tube lugs HR and through connectors HSV (refer to page 46-47), particularly sturdy and easy to handle.

TNF6-50

MECHANICAL TOOLS TNF RANGE

for Cu tube lugs T-M (NFC 20-130), T-L and through connectors L-T



T-M
SERIES



Mechanical tools equipped with rotating dies with hexagonal imprint, suitable to crimp Copper lugs T-M series according to (NFC 20-130), T-L and and through connectors L-T (refer to page 48-49), particularly sturdy and easy to handle.



TECHNICAL FEATURES

Crimping Range	for Cu tube lugs T-M (NFC 20-130), T-L and through connectors L-T for conductor sizes 6 to 50 mm ²
Dimensions mm	
Length	390
Weight kg	1,32

TNF6-120

MECHANICAL TOOLS TNF RANGE

for Cu tube lugs T-M (NFC 20-130), T-L and through connectors L-T



T-M
SERIES



Mechanical tools equipped with rotating dies with hexagonal imprint, suitable to crimp Copper lugs T-M series according to (NFC 20-130), T-L and and through connectors L-T (refer to page 48-49), particularly sturdy and easy to handle.



TECHNICAL FEATURES

Crimping Range	for Cu tube lugs T-M (NFC 20-130), T-L and through connectors L-T for conductor sizes 6 to 120 mm ²
Dimensions mm	
Length	650
Weight kg	3,65

CABLE CUTTERS KT RANGE

for cutting cables Cu and Al

KT

KT1

TECHNICAL FEATURES

Cutting Capacity	Rigid	Multi-Cond.	Flex
Section Cond. mm ²	Cu 16 Al 35	Cu 50 Al 50	Cu 70
Dimensions mm			
Length	170		
Width	45		
Weight g	210		



KT2

TECHNICAL FEATURES

Cutting Capacity	Rigid	Multi-Cond.	Flex
Section Cond. mm ²	Cu 16 Al 50	Cu 50 Al 70	Cu 95
Dimensions mm			
Length	210		
Width	47		
Weight g	294		



KT5

TECHNICAL FEATURES

Cutting Capacity	for cutting cables Cu and Al up to max section 25 sqmm
Dimensions mm	
Length	170
Width	52
Weight g	108



CABLE CUTTERS KT RANGE

for cutting cables Cu and Al

KT3N



TECHNICAL FEATURES

Cutting Capacity	For cutting cables Cu and Al Ø max 34 mm
Dimensions mm	
Length	260
Weight g	600



KT4N



TECHNICAL FEATURES

Cutting Capacity	For cutting cables Cu and Al Ø max 62 mm
Dimensions mm	
Length	297
Weight g	800



5116660250



TECHNICAL FEATURES

Cutting Capacity	For cutting cables Cu and Al Ø max 18 mm
Dimensions mm	
Length	600
Width	140
Weight kg	1,5



5116660500



TECHNICAL FEATURES

Cutting Capacity	For cutting cables Cu and Al Ø max 25,4 mm
Dimensions mm	
Length	800
Width	160
Weight kg	3,0



PROFESSIONAL SCISSORS SC RANGE

for flexible conductors Cu-Al

SC1



Electricians scissors with high tensile steel blades allowing for excellent strength and performance. Specially micro-serrated blades for anti-slip purpose. Handles are made from dual component materials.

TECHNICAL FEATURES

Cutting Capacity	for flexible conductors Cu - Al
Dimensions mm	
Length	145
Width	76
Weight g	78

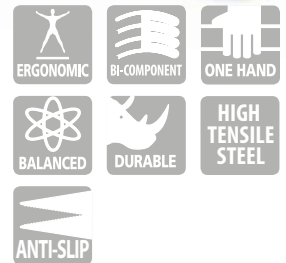

SC3X



Multi-purpose scissors with high hardness blades (56 HRC) and anti slide serrations. The moulded plastic handles combine a rigid structure with a softer material for finger comfort. **Cutting of flexible conductors up to 35 sqmm**

TECHNICAL FEATURES

Cutting Capacity	for flexible conductors Cu - Al up to max section 35 sqmm
Dimensions mm	
Length	150
Width	75
Weight g	86

Professional scissors with Special Steel frame, high hardness blades (58 HRC) and anti slide serrations. The moulded plastic handles combine a rigid structure with a softer material for finger comfort. **Cutting of flexible conductors up to 50 mm²**
Supplied with carry case and swivel belt hook.



SC5X

Robust-A



TECHNICAL FEATURES

Cutting Capacity	for flexible conductors Cu - Al up to max section 50 sqmm
Dimensions mm	
Length	162
Width	77
Weight g	121



SC6X Agil-E



Only 86 g weight, the tapered blades and streamlined handles encourage agility and speed of operation. Handles have an integrated crimping system for end sleeves. high hardness blades (58 HRC) and anti slide serrations.

TECHNICAL FEATURES

Cutting Capacity	for flexible conductors Cu - Al up to max section 50 sqmm
Dimensions mm	
Length	153
Width	73,6
Weight g	86

Cutting of flexible conductors up to 50 mm²
Supplied with carry case belt hook.



HB13UE

CABLE STRIPPING TOOLS HB RANGE

for external sleeves of Low/Medium Voltage cables



Universal cable stripping tool for external sleeves of Low/Medium Voltage cables Ø 12,7 to 63,5 mm and primary insulator in XLPE max Ø 38,1 mm



HB12N

For vulcanised extruded semiconductor



HB12N cable stripping tool removes the semiconductor layer by being manually rotated around the cable while lateral advancement is achieved automatically. Safe and convenient, it can be used on cables with a semi-con diameter between 18 - 60 mm.

- Sturdy frame in anodised Aluminium alloy and Steel.
- Special Steel blade with precise cutting depth regulation.
- Stripping operation can start at any point along the conductor.
- Bearing mounted rollers provide smooth cutting action.
- With "REVERSE" function, which allows the removal of semiconductor up to 7 mm thick from the sheath of the cable.
- Double speed for each direction.



The HB 12N kit includes:

- HB 12N cable stripping tool
- sturdy plastic case

HB2

Cable stripping tool for circular cables Ø 4,5 to 28,5 mm



HB10

Insulated knife has an interchangeable straight blade and plastic blade protector that folds into the handle. Ergonomic handle made of anti shock plastic material.



HB9

Insulated knife, with curved blade and protective cover. Suitable for insulation and screen removal, equipped with blade guide to avoid damage to strands. Handle is made of a bi-component plastic material.



WIRE STRIPPERS HB RANGE

for insulated cables

Interchangeable stripping dies available upon request:



4320-0866, rounded blades
suitable for:
PVC from 4 to 16 sqmm



4320-0864, flat blade
suitable for:
PVC from 0,02 to 10 sqmm



4320-0865, 'V' blades
suitable for:
PTFE from 0,1 to 4 sqmm



Wire strippers,
including stripping die for PVC
insulated cables 0,02 to 10 sqmm

HB11



For photovoltaics insulated
cables 2,5 to 6 sqmm
stripping length 8,5 mm



HAND TOOLS

for cutting and sealing flexible plastic conduit



TECHNICAL FEATURES

Dimensions mm

Length	230
Width	58
Thickness	32
Weight kg	0,32



Cuts and seals flexible plastic
conduit in a single operation.
Lightweight and easy to operate.
Suitable for flexible conduits
from Ø16 to Ø32 mm.

for cutting plastic pipe



Body: die-cast aluminium alloy
Blade material: hardened Carbon
Steel

TECHNICAL FEATURES

Dimensions mm

Length	195
Width	96
Thickness	27
Weight kg	0,32



Plastic pipe cutting tool
Cutting capacity: Ø 6 to Ø 42 mm.

HB6

KTS1632

PC1

MT-FC48N

FRAME-TYPE HOLE PUNCHING TOOL

for cable trunking



Lightweight and easy to operate, designed for punching holes up to 47,2 mm diameter in the side wall of trunking without the need for pre drilling.



TECHNICAL FEATURES

Dimensions mm

Length	251,5
Width	224
Thickness	66
Weight kg	3,28

VAL-P30

Supplied in a robust plastic case.

Table denotes the punch/die set reference, for each hole size. Suitable for punching holes in mild steel, fibreglass or plastic material, up to 2 mm thick.

Hole Dimensions					Maximum thickness of mild steel (mm)	Type
Nominal		Pg	ISO	Inch		
Ø (mm)	Ø (inch)					
15,5	.610	Pg9	-	-	2	RD15.5SS-FC
16,2	.638	-	ISO-16	-		RD16.2SS-FC
17,5	.689	-	-	-		RD17.5SS-FC
18,8	.740	Pg11	-	-		RD18.8SS-FC
19,1	.752	-	-	-		RD19.1SS
20,5	.807	Pg 13,5	ISO-20	-		RD20.5SS
22,6	.890	Pg16	-	-		RD22.6SS
23,8	.937	-	-	5/8"		RD23.8SS
25,4	1.000	-	ISO-25	-		RD25.4SS
27,0	1.063	-	-	3/4"		RD27.0SS
28,5	1.122	Pg21	-	-		RD28.5SS
30,5	1.201	-	-	7/8"		RD30.5SS
31,8	1.252	-	-	-		RD31.8SS
32,5	1.279	-	ISO-32	-		RD32.5SS
34,6	1.362	-	-	-		RD34.6SS
37,2	1.464	Pg29	-	-		RD37.2SS
38,1	1.500	-	-	-		RD38.1SS
40,5	1.594	-	ISO-40	-		RD40.5SS-FC
41,3	1.626	-	-	-		RD41.3SS-FC
42,5	1.673	-	-	1"1/4"		RD42.5SS-FC
43,2	1.701	-	-	-	RD43.2SS-FC	
44,5	1.752	-	-	-	RD44.5SS-FC	
47,2	1.858	Pg36	-	-	RD47.2SS-FC	

BENCH PRESS TOOLS

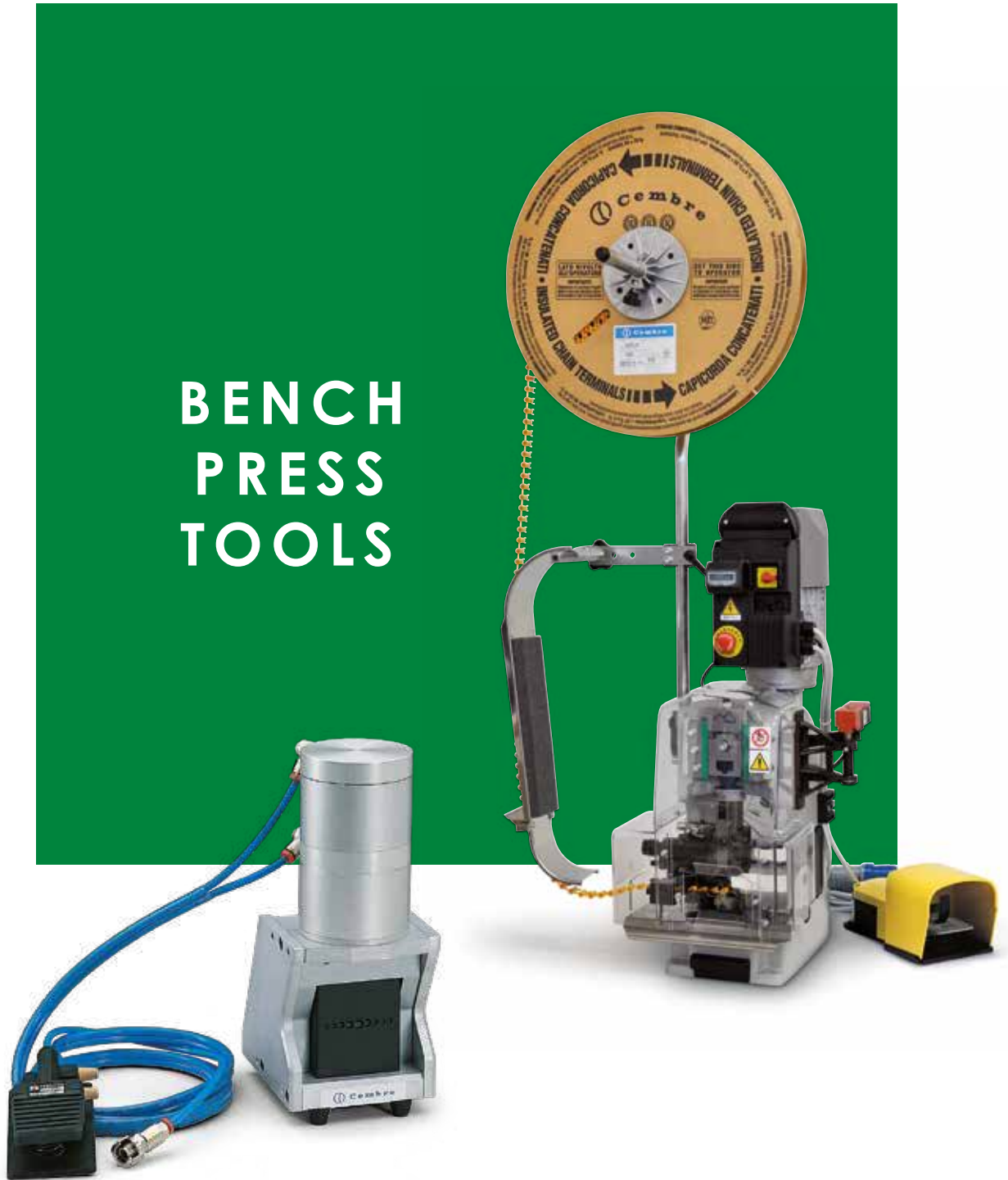

PNB-1

BENCH PRESS TOOL

Pneumo-hydraulic with interchangeable dies



Pneumo-hydraulic, production bench press, operated by a manual control, provides a consistent and reliable crimped connection. Extensive range of interchangeable dies available for crimping a wide variety of connectors.

NOTE: for applications not listed, please contact Cembre.



PNB-1 detail of the crimping zone with PU-1 guard.

TECHNICAL FEATURES

Nominal operating pressure	6 bar
Dimensions mm	
Width	180
Depth	320
Height	700
Weight kg (without dies)	23

INTERCHANGEABLE DIES (to be ordered separately)

Die Set	Guard*	Connector Type			Nominal Conductor Size sqmm			
PV-1	PU-1	Insulated Connectors	green	0,2÷0,5				
PR-1			red	0,25÷1,5				
PB-1			blue	1,5÷2,5				
PG-1			yellow	4÷6				
PH1-1	PH-1**	Through connectors PE HD insulated		0,5÷6				
		NL-M, NL-P connectors PA6.6 insulated		0,25÷6				
KE0.75-1	PK-1	End Sleeves	KE, PK...	0,3 - 0,5 - 0,75				
KE2.5-1				1 - 1,5 - 2,5				
KE10-1				4 - 6 - 10				
MTT16-50	ME-1			16				
MTT25-50				25				
N1-1	PU-1	A 03-M..	S 1.5-..	RN-..	0,25 - 1,5			
		A 06-M..	S 2.5-..	BN-..	1,5 - 2,5			
		A 1-M..	S 6-..	GN-..	4 - 6			
ME1-50	ME-1	Uninsulated Copper Lugs		A1-M..	4 - 6			
ME2-50				A2-M.. S10-M..	10			
ME3-50				A3-M..	16			
ME5-50				A5-M..	25			
ME7-50				A7-M..	35			
ME9-50				A9-M..	50			
ME10-50				A10-M..	50			
ME12-50				A12-M..	50			
NEW MS6-50				ME-1	Uninsulated Copper Lugs		T6-M	4 - 6
NEW MS10-50							T10-M	10
NEW MS16-50	T16-M	16						
NEW MS25-50	T25-M	25						
NEW MS35-50	T35-M	35						
NEW MS50-50	T50-M	50						
MN2RF-50	MN RF-1	Polyamide Insulated Lugs		ANE2-M..	10			
MN3RF-50				ANE3-M..	16			
MN5RF-50				ANE5-M..	25			
MN7RF-50				ANE7-M..	35			
				ANE9-M..	35			

* Supplied as standard with the machine ** Supplied as standard with the die

BENCH PRESS TOOL

Pneumatic

PNB-3

TECHNICAL FEATURES

Nominal operating pressure	6±7 bar
Dimensions mm	
Width	130
Depth	370
Height	195
Weight kg	10,3



PNB-3P detail of the crimping zone.

Pneumatic bench press operated by foot pedal for crimping terminals and connectors 0,25 to 16 sqmm.



BENCH PRESS RANGE

Type	Connector Type	Conductor Size sqmm
PNB-3P*	Insulated connectors red, blue and yellow	0,25÷6
PNB-3PD	Insulated terminals and butt connectors - frontal insertion	0,25÷6
PNB-3N1	Uninsulated terminals	0,25÷10
PNB-3N5	Uninsulated terminals	10÷16
PNB-3NN3	Polyamide insulated terminals	1,5÷10
PNB-3NN4	Polyamide insulated terminals	10÷16
PNB-3F/M	Bullet connectors	0,5÷2,5

* Will also crimp Polycarbonate fully-insulated terminals if fitted with PNB3F/M positioner, available as an optional accessory (Cod. 6240145)

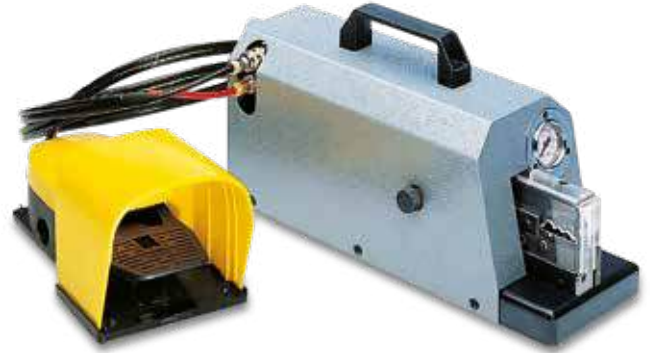

BENCH PRESS TOOL

Pneumatic with multi-aperture die

PNB-4KE

TECHNICAL FEATURES

Nominal operating pressure	6 bar
Dimensions mm	
Width	120
Depth	160
Height	300
Weight kg	6



PNB-4KE detail of the crimping zone.

Pneumatic bench press, operated by a manual control.

Supplied with a multi-aperture die suitable for crimping insulated and uninsulated end sleeves from 0,3 to 10 sqmm.

Compact and efficient. Easy to operate, producing a secure and reliable crimped connection.



MULTI DIES

Type	Connector Type	Conductor Size sqmm
PNB-4KE	End Sleeves type PK... and type KE	0,3÷10



EPB-1N

ELECTRO-PNEUMATIC BENCH PRESS

automatic stripping / crimping machine for insulated end sleeves



Bench press type EPB-1N, electro-pneumatically operated, is designed for stripping and crimping insulated end sleeves Cembre type PKC, PKD and PKE.

The basic configuration processes connectors of c.s.a 0,5/0,75/1,0 and 1,5 mm² with a sleeve lengths of 6, 8, 10 and 12 mm.

Adapter kits are available:

KIT-2.5-EPB1N

for insulated end sleeves c.s.a 2,5 sqmm with a sleeve length of 8, 10 and 12 mm

KIT-4-EPB1N

for insulated end sleeves c.s.a 4,0 sqmm with a sleeve length of 10 mm

Stripping and crimping operations are carried out in quick succession. Adjustable loading speed of vibrating charger.

Quick and easy change of configuration for different connector sizes. Automatic adjustment of operating parameters to suit each configuration.

Modular structure and wear-free components guarantee excellent reliability.



Adapter Kit for insulated end sleeves c.s.a 2,5 sqmm (KIT-2.5-EPB1N) (KIT-4-EPB1N)



TECHNICAL FEATURES

Crimping Range	0,5-1,5 mm ² (basic configuration)
Dimensions mm	
Length	390
Width	240
Height	490
Weight kg	29
Power Supply	230 V/50 Hz (110 V/60 Hz)
Current	0,5 A
Length of crimp	6, 8, 10 and 12 mm
Geometry of crimp	Trapezoidal
Cycle time	2 s
Compressed Air supply	Min. 4 - Max 6 bar
Air consumption	1,2 l/cycle
Cycle controller	Electro-pneumatic, with microprocessor
Counter	Digital

PNEUMATIC CRIMPING TOOLS

Hand held - PNB series

PNB-6KE TECHNICAL FEATURES

Crimping Range	0,25 ÷ 2,5 sqmm / 24 ÷ 14AWG
Dimensions mm	
Length	190
Width Ø	44
Length with spiral hose	2 m
Weight g	450

PNB-7KE TECHNICAL FEATURES

Crimping Range	4 ÷ 10 sqmm / 12 ÷ 8AWG
Dimensions mm	
Length	190
Width Ø	44
Length with spiral hose	2 m
Weight g	450



PNB-6KE and PNB-7KE hand tools facilitate the rapid crimping of insulated end sleeves while avoiding the operator discomfort associated with ordinary manual tools. Lightweight and easy to use, these tools are ideal for panel building applications and component assembly.

Both tools are designed to be maintenance-free and need no routine calibration. A 4-6 bar air supply is required for connection via the quick coupler fitted to the hose supplied with the tool.



PNEUMATIC CRIMPING TOOLS

Bench mounted tools with foot pedal - PNB series

PNB-6KE-T TECHNICAL FEATURES

Crimping Range	0,25 ÷ 2,5 sqmm / 24 ÷ 14AWG
Dimensions mm	
Length	200
Width Ø	135
Height	75
Length with spiral hose	2 m
Weight g	1000

PNB-7KE-T TECHNICAL FEATURES

Crimping Range	4 ÷ 10 sqmm / 12 ÷ 8AWG
Dimensions mm	
Length	200
Width Ø	135
Height	75
Length with spiral hose	2 m
Weight g	1000

PNB-6KE-T and PNB-7KE-T have bench mounts with storage and are foot pedal operated to allow operators to have both hands free when assembling cable harnesses. Both tools are designed to be maintenance-free and need no routine calibration.



A 4-6 bar air supply is required for connection via the quick coupler fitted to the hose supplied with the tool.

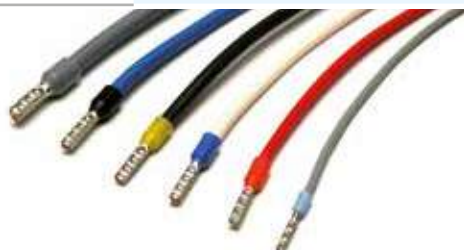



Electro-pneumatic, production bench press, controlled by a foot operated pedal. Producing a consistent and reliable crimped connection. Interchangeable application heads available to suit the complete range of Polycarbonate insulated connectors.

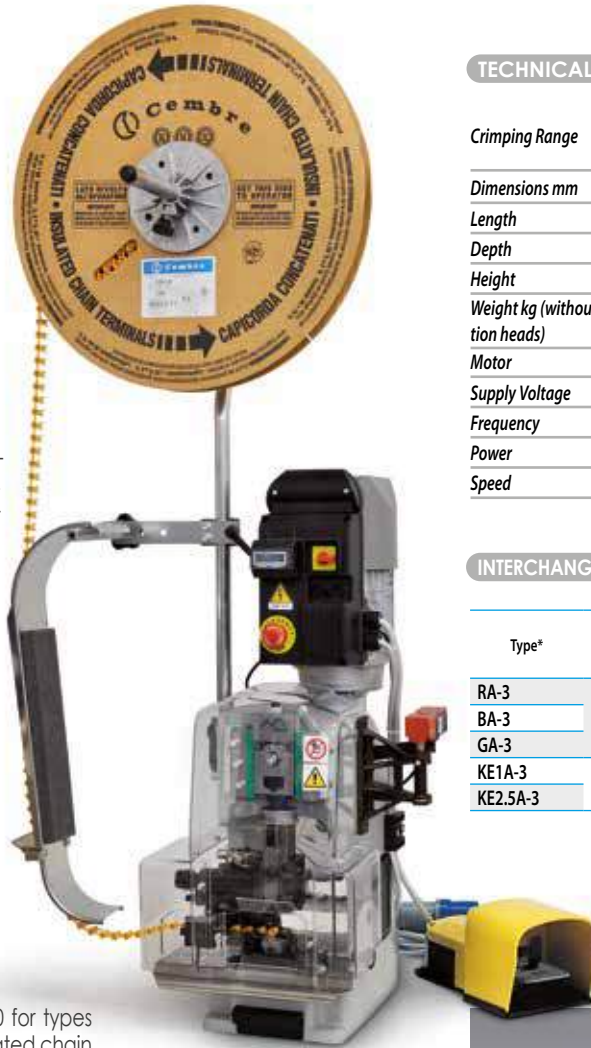

TECHNICAL FEATURES

Crimping Range	Polycarbonate insulated chain terminals 0,25 ÷ 6 mm ² and insulated chain end sleeves 0,5 ÷ 2,5 mm ²
Dimensions mm	
Length	180
Depth	250
Height	620
Weight kg (without application heads)	41
Motor	
Supply Voltage	220 V
Frequency	50 Hz
Power	0,55 kW/0,75 HP
Speed	2.800 g/1'

INTERCHANGEABLE APPLICATION HEADS, SIDE ENTRY WITH PNEUMATIC FEED

Type*	Connectors	Conductor Size sqmm
RA-3	Polycarbonate insulated chain terminals	0,25÷1,5
BA-3		1,5÷2,5
GA-3		4÷6
KE1A-3	Insulated chain end sleeves	0,5÷1
KE2.5A-3		1÷2,5

* order as required

See pages 12-13 and 20 for types and features of the insulated chain connectors and end sleeves.



Conforms to DIN Standard 46 228/4

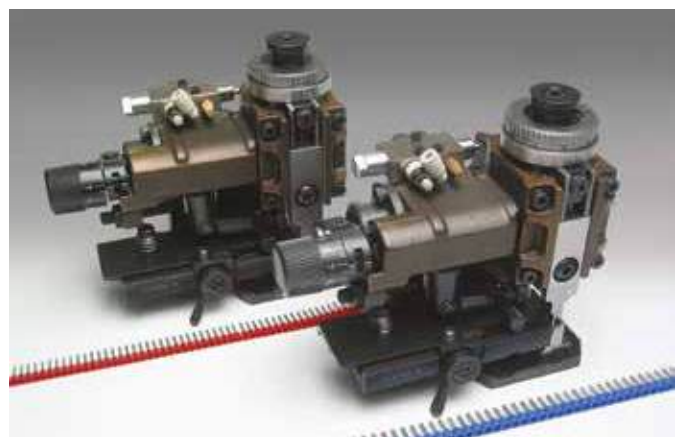



















HYDRAULIC TOOLS AND HEADS



SYMBOL DESCRIPTION

hydraulic tools and heads

	Crimping force kN		Provided with a maximum pressure valve that allows to check the correct execution of the compressions or the limit switch control of the blades
	Double speed action: a rapid approach speed and a slower more powerful speed for crimping or cutting		Manual pressure release button
	Openable compression head, ideal for derivations from running conductors		Ergonomically designed with a sculptured body for operator comfort
	Openable cutting head, ideal for cutting running cables		Lightweight and balanced tool for greater control
	Tool with a large 42 mm jaw opening, for easier introduction/removal of large size compression terminations and joints		Dual-compound plastic handles. Greater safety and comfort in handling, thanks to the rubber inserts
	Blades manufactured from high strength special Steel, heat treated to ensure a long service life		Durable moulded body offering high resistance to wear and damage in all operating conditions
	Max cutting diameter		CE marking
	Max hole punching diameter		UKCA marking
	The head can rotate to enable the operator to work in the most comfortable position		
	Can be operated with one hand		

SYMBOL DESCRIPTION

hydraulic tools and heads



Hexagonal crimp



Contains isolated oil



Radial crimp



Hydraulic units provide protection against short circuit when accidentally cutting live L.V. / M.V. cables with nominal voltage up to 60 kV



Indent crimp



Deep indent crimp



Oval crimp



Trapezium crimp



Circular crimp



Max operating pressure



HT45-E

HYDRAULIC CRIMPING TOOL

general features



MAIN APPLICATIONS - max section sqmm

Section sqmm	0,25÷1,5	1,5÷2,5	4÷6	10	16	25	35	50	70	95	120	150	185	240	300	400	500	630	800	1000	
L.V. lugs and splices																					
"C" sleeve Connectors																					

These tools are supplied without dies. For die selection, please refer to chart on pages 260 to 274

TECHNICAL FEATURES

Crimping force kN	50
Dimensions mm	
Length	346
Width	130
Weight kg	2,0

STORAGE

Type	VAL-P1*
Dimensions mm L x W x H	445 x 290 x 95
Weight kg	1,2
Supplied with the tool	✓

*Suitable for storage of the tool and 20 sets of dies



Lightweight and compact, this tool is ideal for the compression of connectors for general applications.

Having the benefit of spring loaded handles, the dies can be advanced using only one hand; therefore leaving the other hand free to position the connector.

For ease of operation and comfort of the operator, the tool head can be fully rotated through 180 degrees.

The built-in safety valve will by-pass the oil supply when the maximum pressure is reached, and a pressure releasing system can easily be operated at any stage of the compression.



Openable head, ideal for derivations from running conductors

180° rotatable head, to work in the most comfortable position

Safety valve bypassing the oil supply when the maximum pressure is reached

Pressure releasing system, that can be operated at any stage



The operator can advance the dies using only one hand, leaving the other hand free to position the connector.

HYDRAULIC CRIMPING TOOL

HT51

general features

MAIN APPLICATIONS - max section sqmm

Section sqmm	0.25-1.5	1.5-2.5	4-6	10	16	25	35	50	70	95	120	150	185	200	240	300	400	500	630	800	1000	
L.V. lugs and splices																						
Insulated terminals																						
End sleeves																						
"C" sleeve Connectors																						
H.V. lugs and splices																						

These tools are supplied without dies. For die selection, please refer to chart on pages 260 to 274

TECHNICAL FEATURES

Crimping force kN	50
Dimensions mm	
Length	380
Width	130
Weight kg	2,7

STORAGE

Type	VAL-P1*
Dimensions mm L x W x H	445 x 290 x 95
Weight kg	1,2
Supplied with the tool	✓

* Suitable for storage of the tool and 20 sets of dies



HT51-KV version also available for Power Supply Companies



New design two speed hydraulic tool, lightweight and compact, this tool is ideal for working in confined spaces.

Having the benefit of spring loaded handles, the dies can be advanced using only one hand; therefore leaving the other hand free to position the connector.

For ease of operation and comfort of the operator, the tool head can be fully rotated through 180 degrees. The built-in safety valve will by-pass the oil supply when the maximum pressure is reached, and a pressure release system can easily be operated at any stage of the compression.

HT51 COMPRESSION KIT

general features

KIT-HT51-1

Kit includes:

HT51 Hydraulic tool	
VAL-P1 plastic carrying case	
8 die sets:	
ME5-50	Hexagonal crimp for low voltage terminals and through connectors from 25 to 185 mm ² A-M family
ME7-50	
ME10-50	
ME14-50	
ME19-50	
ME24-50	
ME30-50	
ME37-50	

KIT-HT51-2

Kit includes:

HT51 Hydraulic tool		
VAL-P1 plastic carrying case		
6 die sets:		
Nest	Indent	Indent crimp for low voltage general purpose terminals and through connectors from 25 to 120 mm ²
MA5-50	PA5-50	
MA7-50	PA10-50	
MA10-50		
MA14-50	PA19-50	
MA19-50	PA24-50	

KIT-HT51-MK

Kit includes:

HT51 Hydraulic tool	
VAL-P1 plastic carrying case	
9 die sets:	
MK8-50	Hexagonal crimp for low voltage terminals and through connectors from 16 to 185 mm ² DIN 46235 family
MK10-50	
MK12-50	
MK14-50	
MK16-50	
MK18-50	
MK20-50	
MK22-50	
MK25-50	

KIT-HT51-1 KIT-HT51-2 KIT-HT51-MK



RH50



Hydraulic presshead complete with quick automatic coupler for connection to a hydraulic pump with a working pressure of 700 bar max, (see page 226-232). RH50 is suitable for installing the same range of connectors as HT51.

HYDRAULIC PRESSHEAD

general features

MAIN APPLICATIONS - max section sqmm

Section sqmm	0,25-1,5	1,5-2,5	4-6	10	16	25	35	50	70	95	120	150	185	200	240	300	400	500	630	800	1000	
L.V. lugs and splices																						
Insulated terminals																						
End sleeves																						
"C" sleeve Connectors																						
H.V. lugs and splices																						

These tools are supplied without dies. For die selection, please refer to chart on pages 260 to 274

TECHNICAL FEATURES

Crimping force kN	50
Max operating pressure bar	700
Dimensions mm	
Length	195
Width	75
Weight kg	1,6

STORAGE

Type	VAL-P1*
Dimensions mm L x W x H	445 x 290 x 95
Weight kg	1,2
Supplied with the tool	✓
* Suitable for storage of the head and 20 sets of dies	



STORAGE

Type	CVB-007
Dimensions mm L x W	350 x 105
Weight kg	0,13
Purchase separately	✓



RHM50



Hydraulic presshead complete with quick automatic coupler for connection to hydraulic pump with working pressure of 700 bar max, (see page 226-232). RHM50 is suitable for installing the same range of connectors as RH50. Particularly suitable for high volume bench crimping.

HYDRAULIC PRESSHEAD

general features

MAIN APPLICATIONS - max section sqmm

Section sqmm	0,25-1,5	1,5-2,5	4-6	10	16	25	35	50	70	95	120	150	185	240	300	400	500	630	800	1000	
L.V. lugs and splices																					
Insulated terminals																					
End sleeves																					

These tools are supplied without dies. For die selection, please refer to chart on pages 260 to 274

TECHNICAL FEATURES

Crimping force kN	50
Max operating pressure bar	700
Dimensions mm	
Length	210
Width	70
Weight kg	1,6

STORAGE

Type	VAL-P1*
Dimensions mm L x W x H	445 x 290 x 95
Weight kg	1,2
Supplied with the tool	✓
* Suitable for storage of the head and 20 sets of dies	



STORAGE

Type	CVB-007
Dimensions mm L x W	350 x 105
Weight kg	0,13
Purchase separately	✓



HYDRAULIC CRIMPING TOOL

HT60C

general features

MAIN APPLICATIONS - max section sqmm

Section sqmm	0,25-1,5	1,5-2,5	4-6	10	16	25	35	50	70	95	120	150	185	240	300	400	500	630	800	1000	
Cu DIN lugs and splices																					
L.V. lugs and splices																					
End sleeves																					

These tools are supplied without dies. For die selection, please refer to chart on pages 260 to 274

STORAGE

Type	CVB-010
Dimensions mm L x W	545 x 160
Weight kg	0,15
Supplied with the tool	✓

TECHNICAL FEATURES

Crimping force kN	60
Dimensions mm	
Length	382
Width	153
Weight kg	3,0



STORAGE

Type	VAL-75*
Dimensions mm L x W x H	270 x 80 x 30
Weight kg	0,15
Purchase separately	✓

*Suitable for storage 5 sets of dies

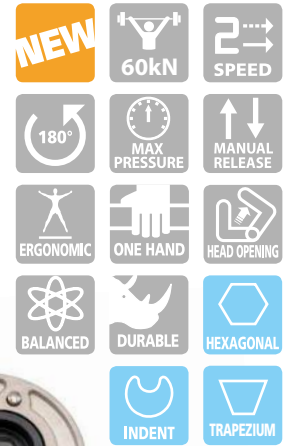

New design two speed hydraulic tool, lightweight and compact, this tool is ideal for working in confined spaces.

Having the benefit of spring loaded handles, the dies can be advanced using only one hand; therefore leaving the other hand free to position the connector. For ease of operation and comfort of the operator, the tool head can be fully rotated through 180 degrees. The built-in safety valve will by-pass the oil supply when the maximum pressure is reached, and a pressure release system can easily be operated at any stage of the compression.

HYDRAULIC PRESSHEAD

RH60C

general features

MAIN APPLICATIONS - max section sqmm

Section sqmm	0,25-1,5	1,5-2,5	4-6	10	16	25	35	50	70	95	120	150	185	240	300	400	500	630	800	1000	
Cu DIN lugs and splices																					
L.V. lugs and splices																					
End sleeves																					

These tools are supplied without dies. For die selection, please refer to chart on pages 260 to 274

TECHNICAL FEATURES

Crimping force kN	60
Max operating pressure bar	700
Dimensions mm	
Length	216
Width	91
Weight kg	1,8

STORAGE

Type	VAL-P26*
Dimensions mm L x W x H	445 x 290 x 115
Weight kg	1,2
Supplied with the tool	✓

*Suitable for storage of the head and 14 sets of dies



Hydraulic presshead complete with quick automatic coupler for connection to a hydraulic pump with a working pressure of 700 bar max, (see page 226-232). RH60C is suitable for installing the same range of connectors as HT60C.

HT81-U

HYDRAULIC CRIMPING TOOL

general features



MAIN APPLICATIONS - max section sqmm

Section sqmm	0.25÷1.5	1.5÷2.5	4÷6	10	16	25	35	50	70	95	100	120	150	185	200	240	300	400	500	630	800	1000	
L.V. lugs and splices																							
"C" sleeve Connectors																							
H.V. lugs and splices																							

These tools are supplied without dies. For die selection, please refer to chart on pages 260 to 274

TECHNICAL FEATURES

Crimping force kN	80
Dimensions mm	
Length	485
Width	141
Weight kg	3,4

STORAGE

Type	VAL-P3*
Dimensions mm L x W x H	620 x 380 x 135
Weight kg	2,5
Supplied with the tool	✓

* Suitable for storage of the tool and three VAL-75

STORAGE

Type	VAL-75*
Dimensions mm L x W x H	270 x 80 x 30
Weight kg	0,15
Purchase separately	✓

* Suitable for storing five sets of dies

This lightweight and self contained tool, features a patented closure and release mechanism for the die locking pin. A wide range of connectors can be crimped with a small number of die sets due to their unique, double groove styling. Dies for cutting Copper, Aluminum, Aldrey and Aluminum-steel, are also available (see table below). The tool features a double speed action: a fast advancing speed for rapid approach of the dies to the connector and a slower more powerful speed for crimping. For ease of operation and comfort of the operator the tool head can be fully rotated through 180 degrees.

The built-in safety valve will by-pass the oil supply when the maximum pressure is reached, and a pressure releasing system can easily be operated at any stage of the compression.



RHU81

HYDRAULIC PRESSHEAD

general features



MAIN APPLICATIONS - max section sqmm

Section sqmm	0.25÷1.5	1.5÷2.5	4÷6	10	16	25	35	50	70	95	100	120	150	185	200	240	300	400	500	630	800	1000	
L.V. lugs and splices																							
"C" sleeve Connectors																							
H.V. lugs and splices																							

These tools are supplied without dies. For die selection, please refer to chart on pages 260 to 274

TECHNICAL FEATURES

Crimping force kN	80
Max operating pressure bar	700
Dimensions mm	
Length	235
Width	91
Weight kg	1,9

STORAGE

Type	CVB-007
Dimensions mm L x W	350 x 105
Weight kg	0,13
Supplied with the tool	✓

Hydraulic presshead complete with quick automatic coupler for connection to a hydraulic pump with a working pressure of 700 bar max, (see page 226-232). This lightweight and self contained head, features a patented closure and release mechanism for the die locking pin. The head is easy to use and is ideally suited for crimping in confined spaces. RHU81 is suitable for installing the same range of connectors as HT 81-U.



HT 81-U and RHU 81 ACCESSORIES FOR CUTTING CONDUCTORS

Die Type	Cutting Capacity		Conductor Type	
	Ø 16 mm		Cu, Alu, Aldrey and Alu-Steel	
MB2-80U	This die is suitable to cut steel conductors (R ≤ 160 daN/mm ²) having the most common strandings, i.e.:			
	19 x 1,2 = Ø est. 6,0 mm	7 x 3,0 = Ø est. 9,0 mm		
	19 x 2,1 = Ø est. 10,5 mm	19 x 2,3 = Ø est. 11,5 mm		
MB3-80U	Suitable to cut aluminium strands of 150 mm ² aluminium-steel conductors, without damage to the steel core.			

HYDRAULIC CRIMPING TOOL

HT120

general features

MAIN APPLICATIONS - max section sqmm

Section sqmm	0.25-1.5	1.5-2.5	4-6	10	16	25	35	50	70	95	120	150	185	200	240	300	400	500	630	800	1000	
L.V. lugs and splices																						
Insulated terminals																						
"C" sleeve Connectors																						
H.V. lugs																						
H.V. Splices*																						

*limited to the cable insulation diameter

These tools are supplied without dies. For die selection, please refer to chart on pages 260 to 274



STORAGE

Type	VAL-P3*
Dimensions mm L x W x H	620 x 380 x 135
Weight kg	2,5
Supplied with the tool	✓

*Suitable for storage of the tool and 14 sets of dies



TECHNICAL FEATURES

Crimping force kN	120
Dimensions mm	
Length	488
Width	138
Jaw opening	25
Weight kg	5,7



This lightweight and self contained tool will accept the semi-circular slotted dies, common to most 130 kN tools.

It is particularly suitable for installing crimp type electrical connectors for overhead line applications.

The tool features a double speed action: a fast advancing speed for rapid approach of the dies to the connector and a slower more powerful speed for crimping.

For ease of operation and comfort of the operator the tool head can be fully rotated through 180 degrees.

The built-in safety valve will by-pass the oil supply when the maximum pressure is reached, and a pressure release system can easily be operated at any stage of the compression.



HT 120-KV version also available for Power Supply Companies



Die release system, protected from accidental operation



Pressure release trigger, which can be operated at any stage of the compression.



HT131-C

HYDRAULIC CRIMPING TOOL

general features



MAIN APPLICATIONS - max section sqmm

Section sqmm	0.25-1.5	1.5-2.5	4-6	10	16	25	35	50	70	95	120	150	185	200	240	300	400	500	630	800	1000	
L.V. lugs and splices																						
Insulated terminals																						
"C" sleeve Connectors																						
H.V. lugs																						
H.V. Splices*																						

*limited to the cable insulation diameter

These tools are supplied without dies. For die selection, please refer to chart on pages 260 to 274

TECHNICAL FEATURES

Crimping force kN	130
Dimensions mm	
Length	473
Width	144
Jaw opening	25
Weight kg	5,5

STORAGE

Type	VAL-P3*
Dimensions mm L x W x H	620 x 380 x 135
Weight kg	2,5
Supplied with the tool	✓

*Suitable for storage of the tool and 14 sets of dies



This new model, self contained, robust and sturdy, will accept all semi-circular slotted dies, common to most 130 kN tools.

The tool features a double speed action: a fast advancing speed for rapid approach of the dies to the connector and a slower more powerful speed for crimping.

For ease of operation and comfort of the operator the tool head can be fully rotated through 180 degrees.

The built-in safety valve will by-pass the oil supply when the maximum pressure is reached, and the pressure release system can easily be operated at any stage of compression.

HT131-C COMPRESSION KIT

general features



KIT-HT131-C-1 KIT-HT131-C-2 KIT-HT131-C-MK



KIT-HT131-C-1

Kit includes:

HT131-C Hydraulic tool

VAL-P3 plastic carrying case

7 die sets:

ME10-C	Hexagonal crimp for low voltage terminals and through connectors from 50 to 240 mm ² A-M family
ME14-C	
ME19-C	
ME24-C	
ME30-C	
ME37-C	
ME48-C	

KIT-131-C-MK

Kit includes:

HT131-C Hydraulic tool

VAL-P3 plastic carrying case

11 die sets:

MK6-C	Hexagonal crimp for low voltage terminals and through connectors from 10 to 240 mm ² DIN 46235 family
MK8-C	
MK10-C	
MK12-C	
MK14-C	
MK16-C	
MK18-C	
MK20-C	
MK22-C	
MK25-C	
MK28-C	

KIT-HT131-C-2

Kit includes:

HT131-C Hydraulic tool

VAL-P3 plastic carrying case

11 die sets:

Nest	Indentor	Indent crimp for low voltage general purpose terminals and through connectors from 10 to 240 mm ²
MA2-C		
MA3-C		
MA5-C	PA10-C	
MA7-C		
MA10-C		
MA14-C		
MA19-C	PA24-C	
MA24-C		
MA30-C		
MA37-C	PA48-C	
MA48-C		

RHC131



Hydraulic presshead complete with quick automatic coupler for connection to a hydraulic pump with a working pressure of 700 bar max, (see page 226-232). This new design with improved mechanical features, is suitable for installing the same range of connectors as HT 131-C.

HYDRAULIC PRESSHEAD

general features

MAIN APPLICATIONS - max section sqmm

Section sqmm	0.25÷1.5	1.5÷2.5	4÷6	10	16	25	35	50	70	95	120	150	185	200	240	300	400	500	630	800	1000	
L.V. lugs and splices																						
Insulated terminals																						
"C" sleeve Connectors																						
H.V. lugs																						
H.V. Splices*																						

*limited to the cable insulation diameter

These tools are supplied without dies. For die selection, please refer to chart on pages 260 to 274

TECHNICAL FEATURES

Crimping force kN	130
Max operating pressure bar	700
Dimensions mm	
Length	232
Width	124
Jaw opening	25
Weight kg	3,8

STORAGE

Type	VAL-P26*
Dimensions mm L x W x H	445 x 290 x 115
Weight kg	1,2
Purchase separately	✓

*Suitable for storage of the head and 14 sets of dies



RHM132



Hydraulic presshead complete with quick automatic coupler for connection to a hydraulic pump with a working pressure of 700 bar max, (see page 226-232).

HYDRAULIC PRESSHEAD

general features

MAIN APPLICATIONS - max section sqmm

Section sqmm	0.25÷1.5	1.5÷2.5	4÷6	10	16	25	35	50	70	95	120	150	185	200	240	300	400	500	630	800	1000	
L.V. lugs																						
Insulated terminals																						
H.V. lugs																						

These tools are supplied without dies. For die selection, please refer to chart on pages 260 to 274

Particularly suitable for high volume bench crimping.

TECHNICAL FEATURES

Crimping force kN	130
Max operating pressure bar	700
Dimensions mm	
Length	216
Width	80
Weight kg	3,1

STORAGE

Type	VAL-P26*
Dimensions mm L x W x H	445 x 290 x 115
Weight kg	1,2
Purchase separately	✓

*Suitable for storage of the head and 14 sets of dies



HYDRAULIC CRIMPING TOOL

general features

MAIN APPLICATIONS - max section sqmm

Section sqmm	0.25±1.5	1.5±2.5	4-6	10	16	25	35	50	70	95	120	150	185	200	240	300	400	500	630	800	1000	
L.V. lugs and splices																						
Insulated terminals																						
"C" sleeve Connectors																						
H.V. lugs and splices																						

These tools are supplied without dies. For die selection, please refer to chart on pages 260 to 274

STORAGE

Type	VAL-P3*
Dimensions mm L x W x H	620 x 380 x 135
Weight kg	2,5
Supplied with the tool	✓

*Suitable for storage of the tool and 14 sets of dies

TECHNICAL FEATURES

Crimping force kN	130
Dimensions mm	
Length	538
Width	144
Jaw opening	42
Weight kg	7,0

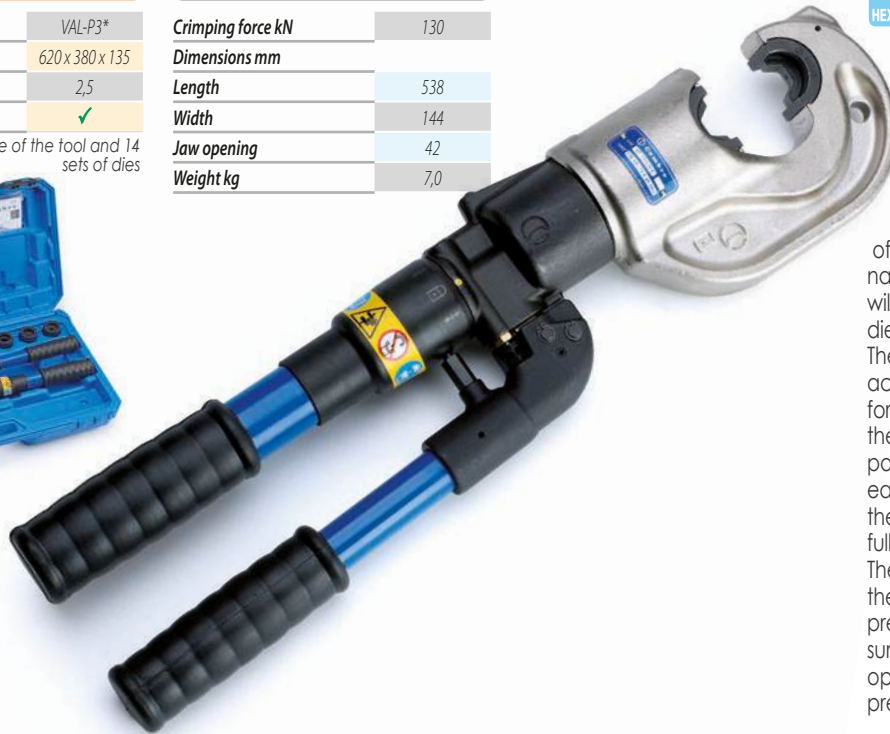

HT131LN-C

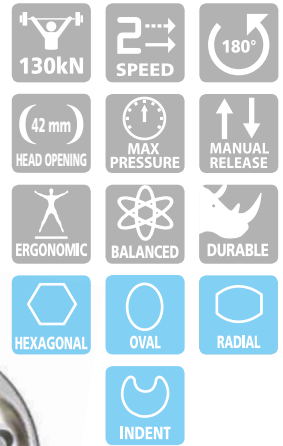

Hydraulic "C" head tool with a large 42 mm jaw opening, for easier introduction/removal of large size compression terminations and joints. The HT131LN-C will accept all semi-circular slotted dies, common to most 130 kN tools. The tool features a double speed action: a fast advancing speed for rapid approach of the dies to the connector and a slower more powerful speed for crimping. For ease of operation and comfort of the operator the tool head can be fully rotated through 180 degrees. The built-in safety valve will by-pass the oil supply when the maximum pressure is reached, and the pressure release system can easily be operated at any stage of compression.

HYDRAULIC PRESSHEAD

general features

MAIN APPLICATIONS - max section sqmm

Section sqmm	0.25±1.5	1.5±2.5	4-6	10	16	25	35	50	70	95	120	150	185	200	240	300	400	500	630	800	1000	
L.V. lugs and splices																						
Insulated terminals																						
"C" sleeve Connectors																						
H.V. lugs and splices																						

These tools are supplied without dies. For die selection, please refer to chart on pages 260 to 274

STORAGE

Type	VAL-P26*
Dimensions mm L x W x H	445 x 290 x 115
Weight kg	1,2
Purchase separately	✓

*Suitable for storage of the head and 14 sets of dies

TECHNICAL FEATURES

Crimping force kN	130
Max operating pressure bar	700
Dimensions mm	
Length	298
Width	122
Jaw opening	42
Weight kg	5,4



RHC131LN



Hydraulic head featuring a large 42 mm jaw opening; complete with quick automatic coupler for connection to a hydraulic pump with a working pressure of 700 bar max, (see page 226-232). Is suitable for installing the same range of connectors as HT 131LN-C.

HT131-UC

HYDRAULIC CRIMPING TOOL

general features



MAIN APPLICATIONS - max section sqmm

Section sqmm	0.25÷1.5	1.5÷2.5	4÷6	10	16	25	35	50	70	95	120	150	185	200	240	300	400	500	630	800	1000	
L.V. lugs and splices																						
Insulated terminals																						
"C" sleeve Connectors																						
Alu lugs and splices																						
H.V. lugs and splices																						

These tools are supplied without dies. For die selection, please refer to chart on pages 260 to 274



This robust and self contained tool will accept the accessories for performing the "Deep Stepped Indent" system of crimping on Aluminium cables. This tool will also accept the semi-circular slotted dies, common to most 130 kN tools. HT 131-UC performance features are the same as those of HT 131-C.

TECHNICAL FEATURES

Crimping force kN	130
Dimensions mm	
Length	488
Width	149
Weight kg	5,4

STORAGE

Type	VAL-P3*
Dimensions mm L x W x H	620 x 380 x 135
Weight kg	2,5
Supplied with the tool	✓

*Suitable for storage of the tool and 14 sets of dies



STORAGE

Type	VAL-130*
Purchase separately	✓

*Suitable for the storage of accessories for crimping Aluminium connectors

RHU131-C

HYDRAULIC PRESSHEAD

general features



MAIN APPLICATIONS - max section sqmm

Section sqmm	0.25÷1.5	1.5÷2.5	4÷6	10	16	25	35	50	70	95	120	150	185	200	240	300	400	500	630	800	1000	
L.V. lugs and splices																						
Insulated terminals																						
"C" sleeve Connectors																						
Alu lugs and splices																						
H.V. lugs and splices																						

These tools are supplied without dies. For die selection, please refer to chart on pages 260 to 274



Hydraulic presshead complete with quick automatic coupler for connection to a hydraulic pump with a working pressure of 700 bar max, (see page 226-232). RHU131-C is suitable for installing the same range of connectors as HT 131-UC.

TECHNICAL FEATURES

Crimping force kN	130
Max operating pressure bar	700
Dimensions mm	
Length	245
Width	89
Weight kg	3,7

STORAGE

Type	VAL-P26*
Dimensions mm L x W x H	445 x 290 x 115
Weight kg	1,2
Purchase separately	✓

*Suitable for storage of the head and 14 sets of dies

STORAGE

Type	VAL-130*
Dimensions mm L x W x H	360 x 280 x 48
Weight kg	3,0
Purchase separately	✓

*Suitable for the storage of accessories for crimping Aluminium connectors

STORAGE

Type	VAL-130-U*
Dimensions mm L x W x H	450 x 305 x 80
Weight kg	5,0
Purchase separately	✓

*Suitable for storage of the head, semi-circular slotted dies and dies for crimping Aluminium connectors



HYDRAULIC PRESSHEAD

general features

MAIN APPLICATIONS - max section sqmm

Section sqmm	0,25±1,5	1,5±2,5	4±6	10	16	25	35	50	70	95	120	150	185	200	240	300	400	500	630	800	1000	
L.V. lugs and splices																						
Insulated terminals																						
"C" sleeve Connectors																						
H.V. lugs and splices																						

These tools are supplied without dies. For die selection, please refer to chart on pages 260 to 274

STORAGE

Type	VAL-ECW-H3D*
Dimensions mm L x W x H	345 x 205 x 90
Weight kg	4,2
Purchase separately	✓

* Suitable for storage of the head and 10 sets of dies

TECHNICAL FEATURES

Crimping force kN	230
Max operating pressure bar	700
Dimensions mm	
Length	290
Width	120
Weight kg	5,5

Hydraulic presshead complete with quick automatic coupler for connection to a hydraulic pump with a working pressure of 700 bar max, (see page 226-232).

ECW-H3D ACCESSORIES FOR CUTTING CONDUCTORS

Die Type	Cutting Capacity	Conductor Type
WT2-3D	Ø 20 mm	Cu, Alu, Aldrey and Alu-Steel
	Ø 20 mm	Extra flexible Steel with ≥ 200 strands
	This die is suitable to cut Steel conductors (R ≤ 160 daN/mm ²) having the most common strandings, i.e.: 19 x 1,2 = Ø est. 6,0 mm 7 x 3,0 = Ø est. 9,0 mm 19 x 2,1 = Ø est. 10,5 mm 19 x 2,3 = Ø est. 11,5 mm	



Adaptor type AU230-130D is available as an optional extra enabling the head to utilise the semi-circular slotted dies which are common to most 130 kN tools. Also available is a series of dies for the compression of DIN electrical connectors, and a die for cutting Copper, Aluminium, aldrej, Aluminium-Steel and Steel conductors.

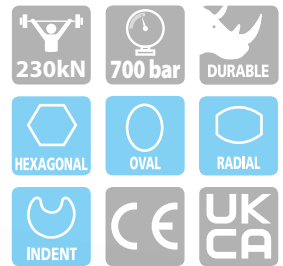

HYDRAULIC PRESSHEAD

general features

MAIN APPLICATIONS - max section sqmm

Section sqmm	0,25±1,5	1,5±2,5	4±6	10	16	25	35	50	70	95	120	150	185	200	240	300	400	500	630	800	1000	
Alu lugs and splices																						
Cu lugs and splices																						

These tools are supplied without dies. For die selection, please refer to chart on pages 260 to 274

STORAGE

Type	VAL-231*
Dimensions mm L x W x H	470 x 273 x 96
Weight kg	7,2
Supplied with the tool	✓
Purchase separately	-

* Suitable for storage of the head and dies for Aluminium compression

TECHNICAL FEATURES

Crimping force kN	230
Max operating pressure bar	700
Dimensions mm	
Length	320
Width	110
Weight kg	6,4

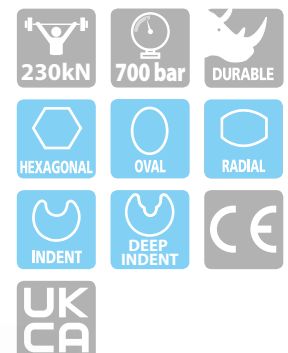

Hydraulic presshead complete with quick automatic coupler for connection to a hydraulic pump with a working pressure of 700 bar max, (see page 226-232).

For crimping up to 500 sqmm Aluminium.

Dies are available also for crimping Copper connectors.

RHU230-630

HYDRAULIC PRESSHEAD

general features



MAIN APPLICATIONS - max section sqmm

Section sqmm	0.25÷1.5	1.5÷2.5	4÷6	10	16	25	35	50	70	95	120	150	185	200	240	300	400	500	630	800	1000	
L.V. lugs and splices																						
Alu lugs and splices																						
"C" sleeve Connectors																						
H.V. lugs and splices																						

These tools are supplied without dies. For die selection, please refer to chart on pages 260 to 274



TECHNICAL FEATURES

Crimping force kN	230
Max operating pressure bar	700
Dimensions mm	
Length	365
Width	193
Weight kg	9,0

STORAGE

Type	VAL-230-630*
Dimensions mm L x W x H	405 x 230 x 145
Weight kg	3,5
Supplied with the tool	✓

*Suitable for storage of the head

STORAGE

Type	VALMAT-230-630*
Dimensions mm L x W x H	290 x 260 x 70
Weight kg	3,1
Purchase separately	✓

*Suitable for storage of the accessories

Hydraulic presshead complete with quick automatic coupler for connection to a hydraulic pump with a working pressure of 700 bar max, (see page 226-232). It allows for crimping up to 630 sqmm Aluminium (according to HN 68 S90). Adapters AU 230-130-C/N, and AU 230-PS/E, are available as an optional extra enabling the head to utilise the semicircular slotted dies which are common to most 130 kN tools.



VAL-230-630

VALMAT-230-630

RHU450

HYDRAULIC PRESSHEAD

general features



MAIN APPLICATIONS - Hexagonal crimp according to DIN 48083 max section sqmm

Section sqmm	0.25÷1.5	1.5÷2.5	4÷6	10	16	25	35	50	70	95	120	150	185	200	240	300	400	500	680	800	1000	1200	
Cu																							
Al																							
Al/St																							

These tools are supplied without dies.

TECHNICAL FEATURES

Crimping force kN	450
Max operating pressure bar	700
Dimensions mm	
Length	260
Width	120
Weight kg	10,3

STORAGE

Type	VAL-450*
Dimensions mm L x W x H	285 x 212 x 124
Weight kg	2,8
Supplied with the tool	✓

* Suitable for storage of the head

Hydraulic presshead complete with quick automatic coupler for connection to a hydraulic pump with a working pressure of 700 bar max, (see page 226-232). Adaptor type AU 450-130 D is available as an optional extra enabling the head to utilise the semi-circular slotted dies which are common to most 130 kN tools.



HYDRAULIC PRESSHEAD

RHU520

general features

MAIN APPLICATIONS - max section sqmm

Section sqmm	0.25-1.5	1.5-2.5	4-6	10	16	25	35	50	70	95	120	150	185	200	240	300	400	500	630	800	1000	1200	
Lugs and splices																							
H.V. overhead lines																							

These tools are supplied without dies. For die selection, please refer to chart on pages 260 to 274

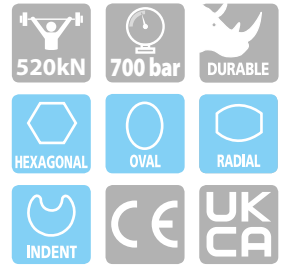

STORAGE

Type	VAL-520*
Dimensions mm L x W x H	384 x 231 x 145
Weight kg	3,2
Purchase separately	✓

*Suitable for storage of the head

TECHNICAL FEATURES

Crimping force kN	520
Max operating pressure bar	700
Dimensions mm	
Length	306
Width	200
Weight kg	18,0

STORAGE

Type	VALMAT-520*
Dimensions mm L x W x H	500 x 310 x 68
Weight kg	5,1
Purchase separately	✓

*Suitable for storage of 10 sets of dies



Hydraulic presshead complete with quick automatic coupler for connection to a hydraulic pump with a working pressure of 700 bar max, (see page 226-232). Adaptor type AU520-130C is available as an optional extra enabling the head to utilise the semi-circular slotted dies which are common to most 130 kN tools.

RHU600

HYDRAULIC PRESSEHEAD

general features



MAIN APPLICATIONS

- "U" Alcoa series die and "L" Burndy series die, etc.
- Aluminium and Copper max size 2156 MCM

These tools are supplied without dies. For die selection, please refer to chart on pages 260 to 274

Hydraulic presshead complete with quick automatic coupler for connection to a hydraulic pump with a working pressure of 700 bar max, (see page 226-232).

TECHNICAL FEATURES

<i>Crimping force kN</i>	600
<i>Max operating pressure bar</i>	700
<i>Dimensions with support mm</i>	
<i>Length</i>	447
<i>Width</i>	241
<i>Weight with support</i>	22,4

STORAGE

<i>Type</i>	VAL-600*
<i>Dimensions mm L x W x H</i>	480 x 235 x 260
<i>Weight kg</i>	8,6
<i>Supplied with the tool</i>	✓

*Suitable for storage of the head



VAL-600

HYDRAULIC PRESSHEAD

RHU1000

general features

These tools are supplied without dies. For die selection, please refer to chart on pages 260 to 274

STORAGE

Type	VAL-1000*
Dimensions mm L x W x H	334 x 244 x 435
Weight kg	12
Supplied with the tool	✓

*Suitable for storage of the head

TECHNICAL FEATURES

Crimping force kN	1.100
Max operating pressure bar	700
Dimensions mm	
Length	414
Width	278
Weight kg	50,6

Operable from single or double acting hydraulic power source



Lifting eye; screwed into the base of the cylinder, allows easy transportation of the head in aerial operation.



RHU 1000 is a 1.100 kN hydraulic presshead for full tension, transmission and substation connections, complete with quick automatic coupler for connection to hydraulic pumps with a working pressure of 700 bar max, (see page 226-232).

The standard version must be operated by a single acting pump; possibility to convert from single to double acting by substitution of the breather valve with a female quick coupling.

RHU1000 will accept all semi-circular slotted dies common to most 100 ton heads as the Alcoa ones.

The die cap is removable for an easy connector positioning; the upper part of the cap automatically rotates during the die changing process to present the correct positioning of the die. Lifting eye included.

Insertion of the upper die:

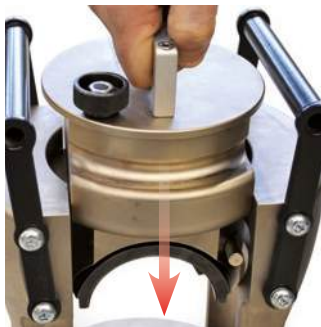

After substitution of the dies, insert the die cap into the head.



Pull the pin.



The upper part of the cap automatically rotates...



...to the correct position.

HT-TC051

HYDRAULIC CUTTING TOOL

industrial application

MAIN APPLICATIONS

specifically designed to cut Copper, Aluminium and Telecommunications cable having Ø max 50 mm



TECHNICAL FEATURES

Max cutting Ø mm	50
Dimensions mm	
Length	497
Width	129
Weight kg	4,38

STORAGE

Type	CVB-010
Dimensions mm L x W	545 x 160
Weight kg	0,15
Supplied with the tool	✓



Hand operated hydraulic tool specifically designed to cut Copper, Aluminium and Telecommunications cable having a max overall diameter of 50 mm.

The tool features a double speed action: a fast advancing speed for rapid approach of the blades to the cable and a slower more powerful speed for cutting.

The blades are manufactured from high strength special Steel, heat treated to ensure a long service life. The head can be easily opened to allow the cutting of running cables.

The head can rotate through 90 degrees, to enable the operator to work in the most comfortable position.

HT-TC051 features an automatic safety valve to bypass oil when reaching maximum pressure; a pressure release device can also be operated at any stage of operation.

TC050

HYDRAULIC CUTTING HEAD

industrial application

MAIN APPLICATIONS

specifically designed to cut Copper, Aluminium and Telecommunications cable having Ø max 50 mm



TECHNICAL FEATURES

Max cutting Ø mm	50
Max operating pressure bar	700
Dimensions mm	
Length	325
Width	112
Weight kg	3,2

STORAGE

Type	CVB-011
Dimensions mm L x W	360 x 137
Weight kg	0,13
Supplied with the tool	✓



Hydraulic cutting head complete with quick automatic coupler for connection to a hydraulic pump with a working pressure of 700 bar max, (see page 226-232)

TC050 features the same cutting capability as HT-TC051.

HYDRAULIC CUTTING TOOL

industrial application

MAIN APPLICATIONS

specifically designed to cut Copper, Aluminium and Telecommunications cable having Ø max 65 mm

STORAGE

Type	CVB-010
Dimensions mm L x W	545 x 160
Weight kg	0,15
Supplied with the tool	✓

TECHNICAL FEATURES

Max cutting Ø mm	65
Dimensions mm	
Length	523
Width	129
Weight kg	5



HT-TC065



Hand operated hydraulic tool specifically designed to cut Copper, Aluminium and Telecommunications cable having a max overall diameter of 65 mm. The tool features a double speed action.

The blades are manufactured from high strength special Steel, heat treated to ensure a long service life. The head can be easily opened to allow the cutting of running cables.

The head can rotate through 320 degrees, to enable the operator to work in the most comfortable position.

HT-TC065 features an automatic safety valve to bypass oil when reaching maximum pressure; a pressure release device can also be operated at any stage of operation.

HYDRAULIC CUTTING HEAD

industrial application

MAIN APPLICATIONS

specifically designed to cut Copper, Aluminium and Telecommunications cable having Ø max 65 mm

STORAGE

Type	VAL-TC065-SC*
Dimensions mm L x W x H	459 x 231 x 122
Weight kg	3,6
Supplied with the tool	✓

*Suitable for storage of the head

TECHNICAL FEATURES

Max cutting Ø mm	65
Max operating pressure bar	700
Dimensions mm	
Length	426
Width	185
Weight kg	6,3



TC065-SC



Hydraulic cutting head complete with quick automatic coupler for connection to a hydraulic pump with a working pressure of 700 bar max, (see page 226-232)

TC065-SC features the same cutting capability as HT-TC065. The open head and the "scissor" movement of the blades facilitate the cutting of running cables.

HT-TC0851

HYDRAULIC CUTTING TOOL

industrial application

MAIN APPLICATIONS

specifically designed to cut Copper, Aluminium and Telecommunications cable having Ø max 85 mm

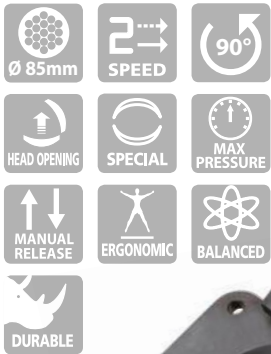

TECHNICAL FEATURES

Max cutting Ø mm	85
Dimensions mm	
Length	652,5
Width	175
Weight kg	6,6

STORAGE

Type	VAL-P7
Dimensions mm L x W x H	727 x 202 x 115
Weight kg	1,3
Supplied with the tool	✓

Hand operated hydraulic tool specifically designed to cut Copper, Aluminium and Telecommunications cable having a max overall diameter of 85 mm. New model, self contained, robust and sturdy. The tool features a double speed action: a fast advancing speed for rapid approach of the blades to the cable and a slower more powerful speed for cutting. The blades are manufactured from high strength special Steel, heat treated to ensure a long service life.

The head can easily be opened to allow the cutting of running cables, and can rotate through 180 degrees, to enable the operator to work in the most comfortable position. HT-TC0851 features an automatic safety valve to bypass oil when reaching maximum pressure; a pressure release device can also be operated at any stage of operation.



TC085

HYDRAULIC CUTTING HEAD

industrial application

MAIN APPLICATIONS

specifically designed to cut Copper, Aluminium and Telecommunications cable having Ø max 85 mm



TECHNICAL FEATURES

Max cutting Ø mm	85
Max operating pressure bar	700
Dimensions mm	
Length	409
Width	135
Weight kg	4,9

STORAGE

Type	VAL-TC085
Dimensions mm L x W x H	465 x 155 x 65
Weight kg	2,4
Supplied with the tool	✓

Hydraulic cutting head complete with quick automatic coupler for connection to a hydraulic pump with a working pressure of 700 bar max, (see page 226-232) TC085 features the same cutting capability as HT-TC0851.

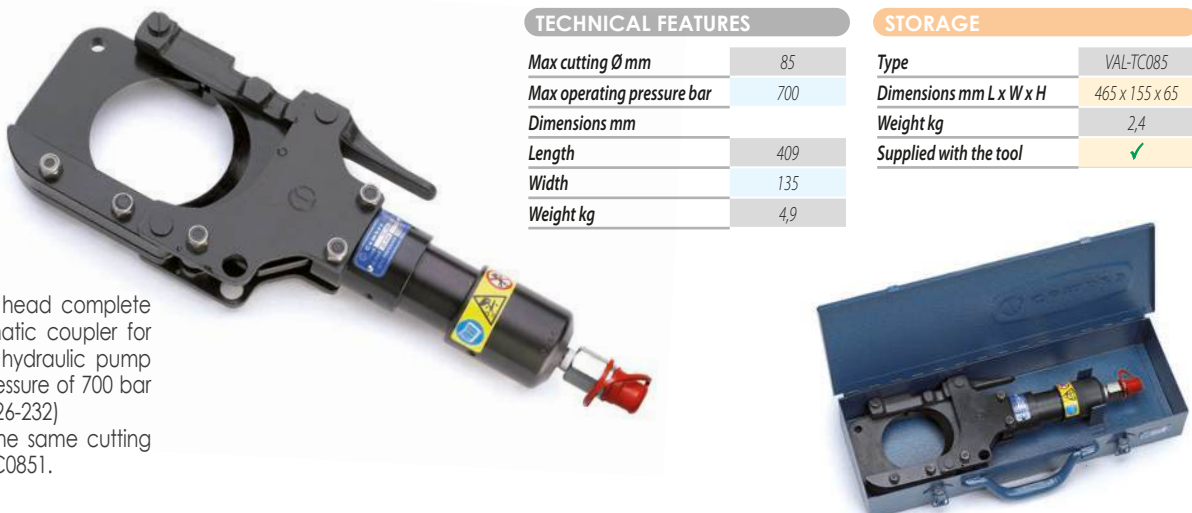

HYDRAULIC CUTTING HEAD

industrial application

MAIN APPLICATIONS

specifically designed to cut Copper and Aluminium cable having Ø max 95 mm

STORAGE

Type	VAL-096
Dimensions mm L x W x H	450 x 265 x 145
Weight kg	6,8
Supplied with the tool	✓

TECHNICAL FEATURES

Max cutting Ø mm	95
Max operating pressure bar	700
Dimensions mm	
Length	397
Width	249
Weight kg	7,9



Hydraulic cutting head specifically designed to cut Copper and Aluminium cable having a max overall diameter of 95 mm.

The head is complete with a quick automatic coupler for connection to a hydraulic pump with a working pressure of 700 bar max, (see page 226-232).



HYDRAULIC CUTTING HEAD

industrial application

MAIN APPLICATIONS

specifically designed to cut Copper, Aluminium and Telecommunications cable having Ø max 120 mm

STORAGE

Type	VAL-TC120
Dimensions mm L x W x H	590 x 209 x 84
Weight kg	4,9
Supplied with the tool	✓

TECHNICAL FEATURES

Max cutting Ø mm	120
Max operating pressure bar	700
Dimensions mm	
Length	536
Width	175
Weight kg	9,5



Hydraulic cutting head specifically designed to cut Copper, Aluminium and Telecommunications cable having a max overall diameter of 120 mm.

The head can easily be opened to cut running cables, and the handle allows the most comfortable positioning of the head onto the cable to be cut.

The head is complete with a quick automatic coupler for connection to a hydraulic pump with a working pressure of 700 bar max, (see page 226-232).



TC 120 cutting capacity - a few examples:

	Section	Conductor Type
Cable Type	3x150 mm ²	Steel armoured Ø80 mm
	1000 mm ²	Cu - EPR rubber insulated; Ø85 mm
	1000 mm ²	Cu - EPR rubber insulated + lead sheath; Ø92 mm
	1000 mm ²	Cu - EPR rubber insulated + lead sheath + PE sheath; Ø100 mm
	240 mm ²	EPR rubber insulated

HT-TC026

HYDRAULIC CUTTING TOOL

overhead line application

MAIN APPLICATIONS

specifically designed to cut Copper, aldrej, Aluminium, Aluminium-Steel cables and Steel ropes, Aluminium and Steel rods having Ø max 25 mm



Hand operated hydraulic tool specifically designed to cut Copper, aldrej, Aluminium, Aluminium-Steel cables and Steel ropes, Aluminium and Steel rods having a max overall diameter of 25 mm.

The tool features a double speed action: a fast advancing speed for rapid approach of the blades to the cable and a slower more powerful speed for cutting.

The blades are manufactured from high strength special Steel, heat treated to ensure a long service life. The head can rotate through 180 degrees, to enable the operator to work in the most comfortable position, and can easily be opened to allow the cutting of running cables.

HT-TC026 features an automatic safety valve to bypass oil when reaching maximum pressure; a pressure release device can also be operated at any stage of operation.

TECHNICAL FEATURES

Max cutting Ø mm	25
Dimensions mm	
Length	382
Width	129
Weight kg	3,2

STORAGE

Type	CVB-001
Dimensions mm L x W	430 x 155
Weight kg	0,15
Supplied with the tool	✓



CUTTING CAPACITY

MATERIAL	TENSILE STRENGTH (daN/mm ²)	MAX CUTTING DIAMETER (mm)	
		HT-TC026 TC 025	HT-TC026Y B-TC250
ROPE & CONDUCTORS	COPPER	≤ 41	25
	ALUMINIUM	≤ 20	25
	ALMELEC	≤ 34	25
	STEEL	≤ 180	INDICATIVE EXAMPLES: 7 x 3,0 : Ø est. = 9,0 mm 19 x 2,1 : Ø est. = 10,5 mm 19 x 2,3 : Ø est. = 11,5 mm
	MULTI STRANDS STEEL (STRANDS Qty ≥ 200)	≤ 180	18
RODS	ACSR	≤ 180	25 INDICATIVE EXAMPLES: 26 x 2,50 + 7 x 1,95 : Ø est. = 15,85 26 x 3,06 + 7 x 2,38 : Ø est. = 19,38 26 x 3,60 + 7 x 2,80 : Ø est. = 22,80
		STEEL	≤ 60 ≤ 42
	COPPER	≤ 30	20
		≤ 25	23
	ALUMINIUM	≤ 16	25

TC025

HYDRAULIC CUTTING HEAD

overhead line application

MAIN APPLICATIONS

specifically designed to cut Copper, aldrej, Aluminium, Aluminium-Steel cables and Steel ropes, Aluminium and Steel rods having Ø max 25 mm



Hydraulic cutting head complete with quick automatic coupler for connection to a hydraulic pump with a working pressure of 700 bar max, (see page 226-232) TC025 has the same cutting capability as HT-TC026.

TECHNICAL FEATURES

Max cutting Ø mm	25
Max operating pressure bar	700
Dimensions mm	
Length	213
Width	82
Weight kg	2,0

STORAGE

Type	CVB-007
Dimensions mm L x W	350 x 105
Weight kg	0,13
Supplied with the tool	✓



HYDRAULIC CUTTING TOOL

HT-TC026Y

overhead line application

MAIN APPLICATIONS

specifically designed to cut Copper, aldrej, Aluminum, Aluminum-Steel cables, stay wire and Steel ropes having Ø max 25 mm and Steel earthing rod up to 16 mm.

STORAGE

Type	CVB-001
Dimensions mm L x W	430 x 155
Weight kg	0,15
Supplied with the tool	✓

TECHNICAL FEATURES

Max cutting Ø mm	25
Dimensions mm	
Length	394,5
Width	129
Weight kg	3,35



Ideal for earthing rod and stay wire

Hand operated hydraulic tool specifically designed to cut Copper, aldrej, Aluminum, Aluminum-Steel cables, stay wire and Steel ropes having a max overall diameter of 25 mm and Steel earthing rod up to 16 mm. The tool features a double speed action.

The blades are manufactured from high strength special Steel, heat treated to ensure a long service life.

The head can rotate through 180 degrees, to enable the operator to work in the most comfortable position, and can easily be opened to allow the cutting of running cables. HT-TC026Y features an automatic safety valve to bypass oil when reaching maximum pressure; a pressure release device can also be operated at any stage of operation.

HT-TC026Y cutting capacity - a few examples:

Ø		EARTHING RODS AND STAY WIRES
mm	in.	
14,2	/	STEEL EARTHING ROD, COPPER PLATED; Tensile strength = 79 daN/mm ²
12,7	1/2"	STEEL EARTHING ROD, COPPER PLATED; Tensile strength = 69 daN/mm ²
15,6	/	STEEL EARTHING ROD; Tensile strength = 69 daN/mm ²
15,9	5/8"	STEEL EARTHING ROD, COPPER PLATED (CON ED - ILLINOIS); Tensile strength = 57 daN/mm ²
15,9	5/8»	STEEL EARTHING ROD, COPPER PLATED (CON ED - STATEN ISLAND); Tensile strength = 78 daN/mm ²
19	3/4"	STEEL EARTHING ROD, COPPER PLATED; Tensile strength = 74 daN/mm ²
9,15 (3,05x7)	/	STAY WIRE
10,8 (3,6x7)	/	STAY WIRE (PORTLAND GENERAL ELECTRIC)
11,1 (3,7x7)	/	STAY WIRE (PORTLAND GENERAL ELECTRIC)
12,3 (4,1x7)	/	STAY WIRE (PORTLAND GENERAL ELECTRIC)
12,6 (4,2x7)	/	STAY WIRE (PORTLAND GENERAL ELECTRIC)

HT-TC041N

HYDRAULIC CUTTING TOOL

overhead line application



MAIN APPLICATIONS

specifically designed to cut Copper, aldrej, Aluminium, Aluminium-Steel cables and Steel ropes, Aluminium and Steel rods having Ø max 45 mm

TECHNICAL FEATURES

Max cutting Ø mm	45
Dimensions mm	
Length	550
Width	144
Weight kg	5,8

STORAGE

Type	VAL-P7
Dimensions mm L x W x H	727 x 202 x 115
Weight kg	1,3
Supplied with the tool	✓



Hand operated hydraulic tool specifically designed to cut Copper, aldrej, Aluminium, Aluminium-Steel cables and Steel ropes, Aluminium and Steel rods having a max overall diameter of 45 mm. New model, even more self contained, robust and sturdy. The blades are manufactured from high strength special Steel, heat treated to ensure a long service life. The head can rotate through 180 degrees, to enable the operator to work in the most comfortable position, and can easily be operated at any stage of operation.

HT-TC041N features an automatic safety valve to bypass oil when reaching maximum pressure; a pressure release device can also be operated at any stage of operation.

CUTTING CAPACITY

MATERIAL	TENSILE STRENGTH (daN/mm ²)	MAX CUTTING DIAMETER (mm)	
		HT-TC041N B-TC450	TC04N
ROPE & CONDUCTORS	COPPER	≤ 41	45
	ALUMINIUM	≤ 20	45
	ALMELEC	≤ 34	45
	STEEL	≤ 180	INDICATIVE EXAMPLES: 7 x 3,0 : Ø est. = 9,0 mm 19 x 2,1 : Ø est. = 10,5 mm 19 x 2,3 : Ø est. = 11,5 mm
	MULTI STRANDS STEEL (STRANDS Qty ≥ 200)	≤ 180	18
	ACSR	≤ 180	45 INDICATIVE EXAMPLES: 26 x 2,50 + 7 x 1,95 : Ø est. = 15,85 26 x 3,06 + 7 x 2,38 : Ø est. = 19,38 26 x 3,60 + 7 x 2,80 : Ø est. = 22,80 54 x 3,50 + 19 x 2,10 : Ø est. = 31,50 54 x 4,36 + 19 x 2,62 : Ø est. = 39,20
	RODS	STEEL	≤ 60
		≤ 42	20
COPPER		≤ 30	30
		≤ 25	32
ALUMINIUM	≤ 16	45	

TC04N

HYDRAULIC CUTTING HEAD

overhead line application



MAIN APPLICATIONS

specifically designed to cut Copper, aldrej, Aluminium, Aluminium-Steel cables and Steel ropes, Aluminium and Steel rods having Ø max 45 mm

TECHNICAL FEATURES

Max cutting Ø mm	45
Max operating pressure bar	700
Dimensions mm	
Length	311
Width	100
Weight kg	4,0

STORAGE

Type	VAL-04
Dimensions mm L x W x H	350 x 125 x 68
Weight kg	2,0
Supplied with the tool	✓



Hydraulic cutting head complete with quick automatic coupler for connection to a hydraulic pump with a working pressure of 700 bar max, (see page 226-232) TC04N has the same cutting capability as HT-TC041N.



HYDRAULIC CUTTING TOOL

overhead line application

MAIN APPLICATIONS

specifically designed to cut Copper, Aluminum, Aluminum-Steel cables (ACSR) having Ø max 50 mm
Not suitable for cutting stay wire, Steel rope or earthing rod

STORAGE

Type	CVB-010
Dimensions mm L x W	545 x 160
Weight kg	0,15
Supplied with the tool	✓

TECHNICAL FEATURES

Max cutting Ø mm	50
Dimensions mm	
Length	503
Width	129
Weight kg	4,7



Hand operated hydraulic tool specifically designed to cut Copper, Aluminum, Aluminum-Steel cables (ACSR) having a max overall diameter of 50 mm. The HT-TC051Y is provided with a two stage hydraulic system, which advances the blades quickly to the cable. This proven system saves operator time and effort.

HT-TC051Y



The HT-TC051Y is provided with an automatic safety valve to bypass oil when reaching max pressure. This means safety to the operator and protection to the blades. The blades are manufactured from high strength special Steel, heat treated to ensure a long service life. The shape of the blades provides a "clean" cut. The head can be opened to allow cutting of running cables and ropes. The head rotates 90 degrees allowing the operator to perform the cut in the most comfortable position. The tool is supplied complete with canvas bag 010 for protection and storage when not in use.

HYDRAULIC CUTTING HEAD

overhead line application

MAIN APPLICATIONS

specifically designed to cut Copper, Aluminum, Aluminum-Steel cables (ACSR) having Ø max 50 mm
Not suitable for cutting stay wire, Steel rope or earthing rod

STORAGE

Type	CVB-011
Dimensions mm L x W x H	360 x 137
Weight kg	0,13
Supplied with the tool	✓

TECHNICAL FEATURES

Max cutting Ø mm	50
Max operating pressure bar	700
Dimensions mm	
Length	331
Width	112
Weight kg	3,3



Hydraulic cutting head complete with quick automatic coupler for connection to a hydraulic pump with a working pressure of 700 bar max. (see page 226-232). TC050Y features the same cutting capability as HT-TC051Y.

HT-TC055

HYDRAULIC CUTTING TOOL

overhead line application

MAIN APPLICATIONS

specifically designed to cut Copper, aldrej, Aluminium, Aluminium-Steel cables and Steel ropes, Aluminium and Steel rods having Ø max 55 mm



TECHNICAL FEATURES

Max cutting Ø mm	55
Dimensions mm	
Length	595
Width	144
Weight kg	8,3

STORAGE

Type	VAL-P7
Dimensions mm L x W x H	727 x 202 x 115
Weight kg	1,3
Supplied with the tool	✓



Hand operated hydraulic tool specifically designed to cut Copper, aldrej, Aluminium, Aluminium-Steel cables and Steel ropes, Aluminium and Steel rods having a max overall diameter of 55 mm.

The HT-TC055 is provided with a two stage hydraulic system, which advances the blades quickly to the cable. This proven system saves operator time and effort.

The HT-TC055 is provided with an automatic safety valve to bypass oil when reaching max pressure. This means safety to the operator and protection to the blades.

The blades are manufactured from high strength special Steel, heat treated to ensure a long service life.

The shape of the blades provides a "clean" cut. The head can be opened to allow cutting of running cables and ropes. The head rotates 330 degrees allowing the operator to perform the cut in the most comfortable position. The tool is supplied complete with plastic case VAL P7 for protection and storage when not in use.

CUTTING CAPACITY

MATERIAL	TENSILE STRENGTH (daN/mm ²)	MAX CUTTING DIAMETER (mm)	
		HT-TC055	TC 055 B-TC550
COPPER	≤ 41	55	
ALUMINIUM	≤ 20	55	
ALMELEC	≤ 34	55	
STEEL	≤ 180	INDICATIVE EXAMPLES: 7 x 3,0 : Ø est. = 9,0 mm 19 x 2,1 : Ø est. = 10,5 mm 19 x 2,3 : Ø est. = 11,5 mm	
MULTI STRANDS STEEL (STRANDS Qty ≥ 200)	≤ 180	22	
ACSR	≤ 180	50 INDICATIVE EXAMPLES: 26 x 2,50 + 7 x 1,95 : Ø est. = 15,85 26 x 3,06 + 7 x 2,38 : Ø est. = 19,38 26 x 3,60 + 7 x 2,80 : Ø est. = 22,80 26 x 4,44 + 7 x 3,45 : Ø est. = 28,14 54 x 3,50 + 19 x 2,10 : Ø est. = 31,50 54 x 4,36 + 19 x 2,62 : Ø est. = 39,20 83 x 4,60 + 16 x 2,80 : Ø est. = 50,00	
GUY WIRE (GW15-9/16-188)	Extra high strength grade	7 x 4,77 : Ø est. = 14,30 mm	
RODS	STEEL	≤ 60	20
		≤ 42	22
	COPPER	≤ 30	34
		≤ 25	38,5
ALUMINIUM	≤ 16	50	

TC055

HYDRAULIC CUTTING HEAD

overhead line application

MAIN APPLICATIONS

specifically designed to cut Copper, aldrej, Aluminium, Aluminium-Steel cables and Steel ropes, Aluminium and Steel rods having Ø max 55 mm



Hydraulic cutting head complete with quick automatic coupler for connection to a hydraulic pump with a working pressure of 700 bar max, (see page 226-232)
TC055 has the same cutting capability as HT-TC055.



TECHNICAL FEATURES

Max cutting Ø mm	55
Max operating pressure bar	700
Dimensions mm	
Length	357
Width	134
Weight kg	6,6

STORAGE

Type	VAL-TC055
Dimensions mm L x W x H	384 x 231 x 145
Weight kg	3,7
Supplied with the tool	✓



FRAME-TYPE HOLE PUNCHING HEAD

RH-FC48N

general features

MAIN APPLICATIONS

designed for punching holes from 15,5 up to 47,2 mm diameter

TECHNICAL FEATURES

Max piercing Ø mm	47,2
Max centre of hole to edge of trunking (mm)	53,5
Max operating pressure bar	700
Dimensions mm	
Length	259,5
Width	147,5
Weight kg	3,7

STORAGE

Type	VAL-P30
Dimensions mm L x W x H	315 x 300 x 95
Weight kg	0,93
Supplied with the tool	✓



Table denotes the punch/die set reference, for each hole size. Suitable for punching holes in mild Steel, fibreglass or plastic material, up to 2 mm thick.

Hole Dimensions				Maximum thickness of mild Steel (mm)	Type
Nominal		Pg	ISO		
Ø (mm)	Ø (inch)				
15,5	.610	Pg9	-	2	RD15.5SS-FC
16,2	.638	-	ISO-16		RD16.2SS-FC
17,5	.689	-	-		RD17.5SS-FC
18,8	.740	Pg11	-		RD18.8SS-FC
19,1	.752	-	-		RD19.1SS
20,5	.807	Pg13,5	ISO-20		RD20.5SS
22,6	.890	Pg16	-		RD22.6SS
23,8	.937	-	-		RD23.8SS
25,4	1.000	-	ISO-25		RD25.4SS
27,0	1.063	-	-		RD27.0SS
28,5	1.122	Pg21	-		RD28.5SS
30,5	1.201	-	7/8"		RD30.5SS
31,8	1.252	-	-		RD31.8SS
32,5	1.279	-	ISO-32		RD32.5SS
34,6	1.362	-	-		RD34.6SS
37,2	1.464	Pg29	-		RD37.2SS
38,1	1.500	-	-		RD38.1SS
40,5	1.594	-	ISO-40		RD40.5SS-FC
41,3	1.626	-	-		RD41.3SS-FC
42,5	1.673	-	1 1/4"		RD42.5SS-FC
43,2	1.701	-	-	RD43.2SS-FC	
44,5	1.752	-	-	RD44.5SS-FC	
47,2	1.858	Pg36	-	RD47.2SS-FC	

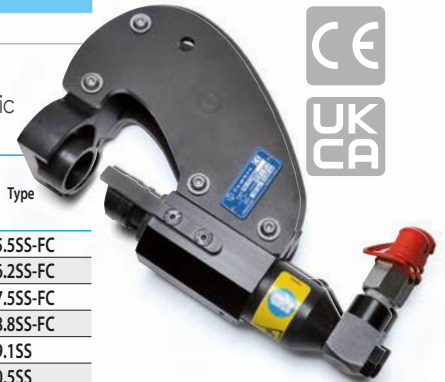

Hydraulic head complete with automatic quick coupler, designed for punching holes from 15,5 up to 47,2 mm diameter in the side wall of trunking without the need for pre drilling.

For operation, the head must be joined to a hydraulic pump developing a pressure of 700 bar (see page 226-232).

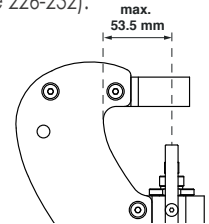

PIERCING HEADS

general features

RHT160

Max piercing Ø mm	21
Max hole distance from bar edge (mm)	30
Max operating pressure bar	700
Dimensions mm	
Length	240
Width	153
Weight kg	6,5

RHT160-60N

Max piercing Ø mm	21
Max hole distance from bar edge (mm)	60
Max operating pressure bar	700
Dimensions mm	
Length	240
Width	181
Weight kg	9,2

STORAGE

Type	VAL-160*
Dimensions mm L x W x H	283 x 180 x 100
Weight kg	2,3
Supplied with the tool	✓

*Suitable for storage of the head



RHT160 RHT160-60N

Hydraulic head complete with automatic quick coupler, for piercing holes of various diameters in Copper, Aluminium and Steel bars with max. thickness of 10 mm.

This compact and handy tool is widely used for transformer room connections, control switch boards and power plants.

For operation the head must be joined to a hydraulic pump developing a pressure of 700 bar (see page 226-232).

Available accessories (to be ordered separately):

Piercing Ø mm	6,5	8,5	9	10,5	11	13	13,5	14	15	17	19	21
Type (Kit Punch+Die)	RT6.5	RT8.5	RT9	RT10.5	RT11	RT13	RT13.5	RT14	RT15	RT17	RT19	RT21
Max. thickness												
Hole diameter (mm)	6,5	8,5	9	10,5	11	13	13,5	14	15	17	19	21
Max thickness step in Copper	10	10	10	10	10	10	10	10	10	10	8	8
Max thickness step in Steel	10	10	10	10	10	9	9	9	8	7	6	4
Punch die/set	RT6.5	RT8.5	RT9	RT10.5	RT11	RT13	RT13.5	RT14	RT15	RT17	RT19	RT21

HT-FL74

PULLER-TYPE HOLE PUNCHING TOOLS

general features



MAIN APPLICATIONS

specifically designed for hole punching stainless Steel, mild Steel, fibreglass and plastic sheet materials up to 3,5 mm thickness

Hand operated hydraulic tool specifically designed for hole punching stainless Steel, mild Steel, fibreglass and plastic sheet materials up to 3,5 mm thickness. Compact, lightweight and easy to handle. The tool is supplied complete with plastic case VAL P28 for protection and storage when not in use. Supplied with Pullers TD-11, TD-19 and spiral bit Ø 11,5 mm. For the punch-die selection chart see page 185.



TECHNICAL FEATURES

Max Punching Ø mm	140
Dimensions mm	
Length	381
Width	138
Weight kg	3,3

STORAGE

Type	VAL-P28
Dimensions mm L x W x H	620 x 360 x 138
Weight kg	2,4
Supplied with the tool	✓



HT-FL75

general features



MAIN APPLICATIONS

specifically designed for hole punching stainless Steel, mild Steel, fibreglass and plastic sheet materials up to 3,5 mm thickness

Hand operated hydraulic tool specifically designed for hole punching stainless Steel, mild Steel, fibreglass and plastic sheet materials up to 3,5 mm thickness. Compact, lightweight and easy to handle. The balanced punching head pivots 180deg through a full 360deg rotation for ease of use in confined spaces.



TECHNICAL FEATURES

Max Punching Ø mm	140
Dimensions mm	
Length	452
Width	138
Weight kg	3,67

STORAGE

Type	VAL-P28
Dimensions mm L x W x H	620 x 360 x 138
Weight kg	2,4
Supplied with the tool	✓



KIT-HT-FL75-1

HOLE PUNCHING KIT

general features



MAIN APPLICATIONS

specifically designed for hole punching stainless Steel, mild Steel, fibreglass and plastic sheet materials up to 3,5 mm thickness

Hand operated hydraulic tool specifically designed for hole punching stainless Steel, mild Steel, fibreglass and plastic sheet materials up to 3,5 mm thickness. Compact, lightweight and easy to handle. The balanced punching head pivots 180deg through a full 360deg rotation for ease of use in confined spaces.



KIT-HT-FL75-1

Kit includes:

HT-FL75 Puller-type hole punching hydraulic tool	
VAL P28 plastic carrying case with accessories	
Puller TD-11	
Puller TD-19	
spiral bit Ø 11,5 mm	
4 KIT for round punch:	
KIT-RD18.8SS	Pg11
KIT-RD20.5SS	Pg13.5
KIT-RD22.6SS	Pg16
KIT-RD28.5SS	Pg21

PULLER-TYPE HOLE PUNCHING HEAD

RH-FL75

general features

MAIN APPLICATIONS

specifically designed for hole punching stainless Steel, mild Steel, fibreglass and plastic sheet materials up to 3,5 mm thickness



STORAGE

Type	VAL-P29
Dimensions mm L x W x H	448 x 288 x 105
Weight kg	1,4
Supplied with the tool	✓



TECHNICAL FEATURES

Max Punching Ø mm	140
Max operating pressure bar	700
Dimensions mm	
Length	163
Width	106
Weight kg	1,9



Hydraulic head, for hole punching stainless Steel, mild Steel, fibreglass and plastic sheet materials up to 3,5 mm thickness. Compact and lightweight, easy to handle in confined spaces due to a rotating 90deg quick automatic coupler for connection to

a hydraulic pump with a working pressure of 700 bar max (see page 226-232). Supplied with Pullers TD-11, TD-19 and spiral bit Ø 11,5 mm. For the punch-die selection chart see table below.

HT-FL74, HT-FL75 and RH-FL75 Punching accessories available

Round punch

Hole diameter				Material max thickness (mm)		Pilot hole Ø (mm)	Type	
Nominal Ø (mm)	Ø (inch)	Pg	ISO	Stainless Steel	Mild Steel		KIT (Punch + Die)	Puller
15,5	.610	Pg9	-	2,5 mm (0.1 in.) Rm= 700 N/mm ²	3,5 mm (0.14 in.) Rm= 510 N/mm ²	11,5	RD15.5SS	TD-11
16,2	.638	-	ISO-16				RD16.2SS	
17,0	.669	-	G3/8"				RD17.5SS	
17,5	.689	-	-				RD17.5SS	
18,8	.740	Pg11	-				RD18.8SS	
19,1	.752	-	-				RD19.1SS	
20,5	.807	Pg 13,5	ISO-20				RD20.5SS	
21,5	.846	-	G1/2"				RD21.5SS	
22,6	.890	Pg16	-				RD22.6SS	
23,8	.937	-	G5/8"				RD23.8SS	
25,4	1.000	-	ISO-25				RD25.4SS	
27,0	1.063	-	G3/4"				RD27.5SS	
28,5	1.122	Pg21	-				RD28.5SS	
30,5	1.201	-	G7/8"				RD30.5SS	
28,5	1.122	Pg 21	-				RD28.5SS-19	
30,5	1.201	-	G7/8"			RD30.5SS-19		
31,8	1.252	-	-			RD31.8SS		
32,5	1.279	-	ISO-32			RD32.5SS		
34,0	1.338	-	G1"			RD34.5SS		
34,6	1.362	-	-			RD34.6SS		
37,2	1.464	Pg29	-			RD37.2SS		
38,1	1.500	-	-			RD38.1SS		
38,5	1.515	-	G1 1/8"			RD38.5SS		
40,5	1.594	-	ISO-40			RD40.5SS		
41,3	1.626	-	-			RD41.3SS		
42,5	1.673	-	G1 1/4"			RD42.5SS		
43,2	1.701	-	-			RD43.2SS		
44,5	1.752	-	-			RD44.5SS		
47,2	1.858	Pg36	-			RD47.2SS		
48,5	1.909	-	G1 1/2"			RD48.5SS		
50,5	1.988	-	ISO-50			RD50.5SS		
51,4	2.023	-	-			RD51.4SS		
52,4	2.063	-	-			RD52.4SS		
54,2	2.134	Pg42	-	RD54.2SS				
60,0	2.362	Pg48	-	RD60.5SS				
60,5	2.381	-	-	RD60.5SS				
64,0	2.520	-	ISO-63	RD64.5SS				
65,0	2.559	-	-	RD65.5SS				
76,0	2.992	-	G2 1/2"	RD76.5SS				
76,5	3.011	-	-	RD76.5SS				
80,5	3.169	-	-	RD80.5SS				
89,0	3.503	-	G3"	RD89.5SS				
90,0	3.543	-	-	RD90.5SS				
100,0	3.937	-	-	RD100.5SS				
102,0	4.015	-	-	RD102.5SS				
114,0	4.488	-	-	RD114.5SS				
120,0	4.724	-	-	RD120.5SS				
140,0	5.512	-	-	RD140.5SS				

* Puller included in the kit

"D" punch

Hole diameter		Material max thickness (mm)		Pilot hole Ø (mm)	Type	
Nominal (mm)	(inch)	Stainless Steel	Mild Steel		KIT (Punch+die + Puller)	
(a)38,3 x (b)36,6	(a)1.507 x (b)1.442	2,5	3,5	18,5	RD 18D	RD 24D
(a)43,1 x (b)41,5	(a)1.696 x (b)1.632					

Stainless Steel = Rm= 700 N/mm² - Mild Steel = Rm= 500 N/mm²

Square punch

Hole diameter		Material max thickness (mm)		Pilot hole Ø (mm)	Type	
Nominal (mm)	(inch)	Stainless Steel	Mild Steel		KIT (Punch+die + Puller)	
21,0 x 21,0	.827 x .827	2,5	3,5	12,0	RD21X21	
46,0 x 46,0	1.811 x 1.811				RD46X46	
68,0 x 68,0	2.677 x 2.677			26,5	RD68X68	
92,0 x 92,0	3.622 x 3.622				RD92X92	
126,0 x 126,0	4.960 x 4.960	1,5	2,0	RD126X126		
138,0 x 138,0	5.433 x 5.433			RD138X138		
220,0 x 220,0	8.661 x 8.661			RD220X220		
224,0 x 224,0	8.818 x 8.818			RD224X224		

Rectangular punch

Hole diameter		Material max thickness (mm)		Pilot hole Ø (mm)	Type	
Nominal (mm)	(inch)	Stainless Steel	Mild Steel		KIT (Punch+die + Puller)	
18,0 x 46,0	.709 x 1.811	2,0	2,0	16,5	RD18X46	
22,0 x 30,0	.866 x 1.181				RD22X30	
22,0 x 46,0	.866 x 1.811				RD22X46	
29,0 x 71,0	1.141 x 2.795				RD29X71	
35,0 x 65,0	1.377 x 2.559				RD35X65	
35,0 x 86,0	1.377 x 3.385				RD35X86	
35,0 x 112,0	1.377 x 4.409			RD35X112		
36,0 x 46,0	1.417 x 1.811			RD36X46		
37,0 x 54,0	1.456 x 2.125			RD37X54		
37,0 x 67,0	1.456 x 2.637			RD37X67		
37,0 x 88,0	1.456 x 3.464			RD37X88		
37,0 x 104,0	1.456 x 4.094			RD37X104		
37,0 x 115,0	1.456 x 4.527	26,5	RD37X115			
46,0 x 54,0	1.811 x 2.126		RD46X54			
46,0 x 72,0	1.811 x 2.835		RD46X72			
46,0 x 92,0	1.811 x 3.622		RD46X92			
46,0 x 107,0	1.811 x 4.212		RD46X107			
50,0 x 98,0	1.968 x 3.858		RD50X98			
67,0 x 126,0	2.637 x 4.960	28,5	RD67X126			
72,0 x 136,0	2.834 x 5.354		RD72X136			

Stainless Steel = Rm= 700 N/mm² - Mild Steel = Rm= 500 N/mm²

Use of non-Cembre punching accessories

Type	Punch & Die	Pilot hole Ø mm
TRD-9.4C (*)	GREENLEE 3/8" - 24 UNF	Ø 10.0
TRD-M11C (*)	BM, COSMEC (M11x1.5), IMB 9602	Ø 11.5
TD-M16C	BM, COSMEC (M16x1.5)	Ø 16.5
TD-27	BM, COSMEC (Ø105=Ø140)	Ø 27.5
TD-14X14-M14	BM, COSMEC 46x46	Ø 18.8
TD-120X20-M20	BM, COSMEC 92x92	Ø 27.5
TD-20X20-M20 (with plug)	BM, COSMEC 42x95	Ø 27.5
TGD-13.5X13.5-M13	BM, COSMEC 40x40; 45x45; 46x46 (M13)	Ø 18.8
TGD-10X10-M9	BM, COSMEC 006505	Ø 13.8
TD-9	IMB 9601	Ø 9.5
TD-16	IMB 9603	Ø 16.5
TD-10X10-M10 (with plug)	IMB 9623	Ø 14.5
TD-14X14-M14/1"	IMB 9625	Ø 19.5
TD-20 (without plug)	IMB 9626	Ø 27.5
TD-20X20-M20-C (with plug)	IMB 9626	Ø 27.5

(*) The washer supplied with the KIT must be threaded onto the draw stud and positioned between the head and the die to allow the die to rest correctly

RHTD

NUT SPLITTING HEADS

general features



RHTD270	
Suitable for splitting nuts mm	16(M10)=27(M18)
Max operating pressure bar	700
Weight kg	1,76

Hydraulic nut splitting head complete with automatic quick coupler. For operating the head must be joined to a hydraulic pump developing a pressure of 700 bar (see page 226-232).

RHTD3241	
Suitable for splitting nuts mm	27(M18)=41(M27)
Max operating pressure bar	700
Weight kg	4,6

RHTD410T	
Suitable for splitting nuts mm	27(M18)=41(M27)
Max operating pressure bar	700
Weight kg	4,9

STORAGE	
Type	VAL-P4
Dimensions mm L x W x H	315 x 300 x 95
Weight kg	0,93
Supplied with the tool	✓

Dimensions mm			
	RHTD270	RHTD3241	RHTD410T
A	40,5	66	77
B	25	36	41
C	105,5	208	222
D	54	75,5	75,5
E	7,5	16	21,5

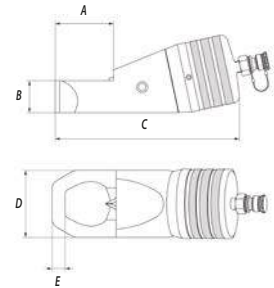

Application range

Type	HEXAGONAL NUTS		SQUARE NUTS	
	mm	Ø	mm	Ø
RHTD270 B-TD270	16	M 10	17	M 10
	17	M 10	19	M 12
	18	M 12	22	M 14
	19	M 12	24	M 16
	21	M 14	27	M 18
	22	M 14		
	24	M 16		
	27	M 18	27	M 18
RHTD3241 RHTD410T B-TD410T	27	M 18	27	M 18
	30	M 20	30	M 20
	32	M 22	32	M 22
	34	M 22	34	M 24
	36	M 24	36	M 27
	41	M 27		

B-TD270



B-TD270	
Crimping force kN	100
Dimensions mm	
Length (with tube and head)	1.292,5
Height	350
Depth	83
Battery	18.0V 5.2Ah
Weight kg (with battery)	5,5

18.0 V battery operated hydraulic tool suitable for splitting fastening bushes, hexagonal and square nuts as per RHTD1724.



STORAGE

Type	CVB-030
Dimensions mm L x W x H	497 x 266 x 455
Weight kg	1,4
Supplied with the tool	✓



B-TD410T



B-TD410T	
Crimping force kN	230
Dimensions mm	
Length (with tube and head)	1.360
Height	350
Depth	83
Battery	18.0V 5.2Ah
Weight kg (with battery)	8,8

18.0 V battery operated hydraulic tool suitable for splitting fastening bushes, hexagonal and square nuts as per RHTD410T.



CORDLESS HYDRAULIC TOOLS



SYMBOL DESCRIPTION

cordless hydraulic tools

	Crimping force kN 63kN		Equipped with safety valve as a additional safety element for the operator
	18.0 V Li-Ion high power batteries		Provided with a maximum pressure sensor that allows to check the correct execution of the compressions
	Double speed action: a rapid approach speed and a slower more powerful speed for crimping or cutting		Pressure release button
	Openable compression head, ideal for derivations from running conductors		Extremely quiet in operation
	Openable cutting head, ideal for cutting running cables		Very little vibration
	Tool with a large 42 mm jaw opening, for easier introduction/removal of large size compression terminations and joints		Ergonomically designed with a sculptured body for operator comfort
	blades manufactured from high strength special Steel, heat treated to ensure a long service life		Lightweight and balanced tool for greater control
	Max cutting diameter Ø 25mm		LED lighting of the working area
	Max hole punching diameter Ø 140mm		Dual-compound plastic body Greater safety and comfort in handling, thanks to the rubber inserts
	The head can rotate to enable the operator to work in the most comfortable position		Ensures optimal use of energy available
	OLED display with multi-function capacitive touch button: Crimping force being generated, Battery power availability, Tool identification, LED state, Reset, No. of operational and service crimping cycles, Tool service required		Durable moulded body offering high resistance to wear and damage in all operating conditions
	Battery condition displayed to show the residual battery power		Crimping cycle data (up to 200,000 events) is automatically stored on a memory card for transfer to PC by USB interface
	Switch protected against accidental operation		Operating temperature range between -15 and +50°C
	Can be operated with one hand		

SYMBOL DESCRIPTION

cordless hydraulic tools



Hexagonal crimp



Radial crimp



Indent crimp



Deep indent crimp



Oval crimp



Trapezium crimp



Circular crimp



Max operating pressure



Manual pressure release button



Fitted with an integral socket, for connection to a 12 V dc external power supply



Contains isolated oil



Hydraulic units provide protection against short circuit when accidentally cutting live L.V. / M.V. cables with nominal voltage up to 60 kV



CE marking



UKCA marking



"Bilinear" configuration

Cembre bilinear tools have their mechanical centre of gravity nearest to the operator's wrist to optimise the overall ergonomics of the tool and provide a wider support for the hand



"Pistol" configuration

The new design and mass distribution favour the easy handling during use



"Standard" configuration

The design allows the maximum stability and comfort in handling and ergonomics



Smart Release Technology

Automatic retraction of the ram only occurs when the operator releases the start button, this allows visual verification of the die to ensure that they have fully met prior to releasing



Electronic Pressure Sensor

The EPS guarantees the precision of the crimping operation, checking the actual value of pressure and informing the operator of possible errors



Electronic Cut Sensor

The ECS guarantees the precision of the cutting operation, checking the complete stroke of the blades and informing the operator about possible errors.



Safe Cut Technology

Fitted with LED indicators and a buzzer to communicate during progress and at the completion of the cutting operation.



Radio Remote Control

Radio control device to utility cable cutting operations in limited access locations, eg. in man-holes, to enable working from a safe distance.



Data recording and intelligent control allow complete verification of operational parameters. SMARTOOL technology enables the user to store data from up to 200,000 cycles on the integrated memory card for transfer to a computer via a USB cable

18.0 V - 5.2 AH CORDLESS TOOL FEATURES

general features

- 1 Head rotates through 180°
- 2 Switch protected against accidental operation
- 3 Pressure release button
- 4 Slot-in battery with release button
- 5 LED lighting of the working area
- 6 Motor ventilation
- 7 Bi-component body for increased impact resistance
- 8 Multifunction OLED display with touch button
- 9 Improved balance for better handling
- 10 Anatomically shaped grip for greater comfort
- 11 18.0 V - 5.2 Ah Li-Ion high power batteries
- 12 SMARTOOL technology for viewing and downloading operational data



SUPPLIED WITH

- 1 CB1852L, 18.0 V - 5.2 Ah Li-Ion high power battery (2 pcs.)
 - 2 ASC55-EU Battery charger with EUROPEAN plug
ASC30-36-UK Battery charger with UK plug
ASC30-36-USA/CA, AC charger (115V) with USA/CANADA plug
ASC30-36-AUS/NZ, AC charger with AUSTRALIAN/NEW ZEALAND plug
(INPUT 220-240 V / 50-60 Hz; OUTPUT 12-42 V DC / 3.0 A max.)
 - 3 USB cable
 - 4 Shoulder strap
- Plastic or Metal carrying case



Multifunction OLED display:

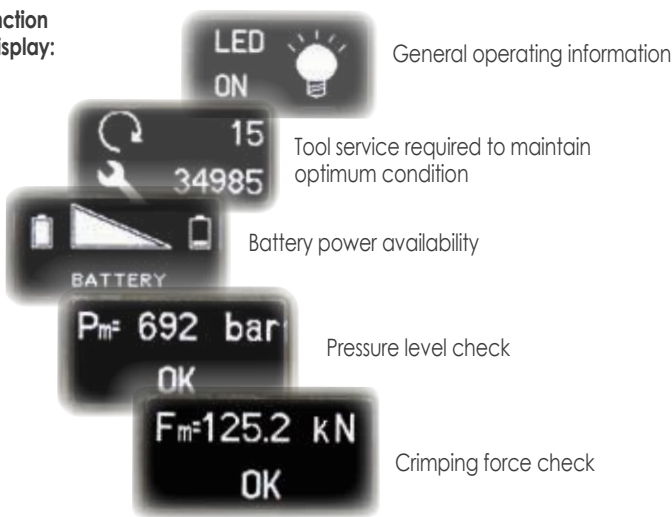

18.0 V - 2.0 AH CORDLESS TOOL FEATURES

general features

- 1 Bilinear mechanical design
- 2 Smart Release system to automatically retract the ram at the end of the crimping cycle
- 3 OLED multifunctional display with touch button
- 4 Electronic Pressure Sensor (EPS)
- 5 SMARTOOL technology for viewing and downloading operational data
- 6 Illumination of working area via 4 x LED lights
- 7 Bi-component plastic body
- 8 Head rotates for ease of operation in confined spaces
- 9 Switch protected against accidental operation
- 10 Pressure release button
- 11 Slot-in battery with release button
- 12 Battery condition displayed to show the residual battery power
- 13 Motor ventilation
- 14 The tools are fitted with a maximum pressure valve to indicate a correct crimping operation or the full extent of the ram travel
- 15 Can be operated with one hand
- 16 Extremely quiet in operation with very little vibration
- 17 Anatomically shaped grip for greater comfort
- 18 18.0 V - 2.0 Ah Li-Ion high power batteries



New Range *nd*



B15MD



SUPPLIED WITH

- 1 CB1820L, 18.0 V - 2.0 Ah Li-Ion high power battery (2 pcs.)
- 2 ASC55-EU Battery charger with EUROPEAN plug
ASC30-36-UK Battery charger with UK plug
ASC30-36-USA/CA, AC charger (115V) with USA/CANADA plug
ASC30-36-AUS/NZ, AC charger with AUSTRALIAN/NEW ZEALAND plug
(INPUT 220-240 V / 50-60 Hz; OUTPUT 12-42 V DC / 3.0 A max.)
- 3 USB cable (not for B15MD)
 - Wrist strap
 - Plastic carrying case



B15MD

18.0 V CORDLESS HYDRAULIC CRIMPING TOOL

general features

Tool Type	Plug Type	Supplied Battery Charger Type
B15MD	PLUG EU	ASC55-EU with EUROPEAN plug
B15MDE	PLUG UK	ASC30-36-UK with UK plug
B15MA	PLUG USA/CA	ASC30-36-USA/CA (115V) with USA/CANADA plug
B15MDT	PLUG AU/NZ	ASC30-36-AUS/NZ with AUSTRALIAN/NEW ZEALAND plug

MAIN APPLICATIONS - max section sqmm

Section sqmm	0,25÷1,5	1,5÷2,5	4÷6	10	16	25	35	50	70	95	120	150	185	240	300	400	500	630	800	1000	
Copper lugs and splices																					
Insulated terminals																					
End sleeves																					

These tools are supplied without dies. For die selection, please refer to chart on pages 260 to 274



The tool is supplied as:

- Basic tool with battery and wrist strap
- Spare battery
- Battery charger
- Plastic carrying case suitable for storing the tool and accessories

TECHNICAL FEATURES

Crimping force kN	15
Dimensions mm	
Length	337
Height	133
Width	81
Battery	18.0V 2.0Ah
Weight kg (with Battery)	1,74

STORAGE

Type	VAL-P22
Dimensions mm L x W x H	465 x 315 x 116
Weight kg	1,5
Supplied with the tool	✓



Can be operated with one hand. Balanced for greater control. Head rotates by 340° for ease of operation in confined spaces. The tool is fitted with a maximum pressure valve. Extremely quiet, minimal vibration. Durable moulded body offering high resistance to wear and damage in all operating conditions. Equipped with Li-Ion 18.0V - 2.0Ah rechargeable high capacity batteries. The battery is equipped with LED indicators to show the remaining battery life at any time by pressing the adjacent button. Supplied in a robust plastic case to accommodate the tool and all the accessories. Two batteries and charger included. Many different interchangeable crimping dies available. Operating temperature: -15 to +50 °C

Many different interchangeable crimping dies available

Conductor Size sqmm (AWG)	Connector Type	Die Set
0,25 ÷ 16	22 ÷ 6 A...; L...-M; L...-P; S...; RN...; BN...; GN...	MA03/3-15
1,5 ÷ 10	16 ÷ 8 A...; L...-M; L...-P	ME03/2-15
10 ÷ 16	8 ÷ 6 A...; 2A...; L...-M; L...-P	ME2/3-15
4 ÷ 10	12 ÷ 8 T... (NF C 20130 style); L...-T	MS4/10-15
10 ÷ 16	8 ÷ 6 T... (NF C 20130 style); L...-T	MS10/16-15
10 ÷ 16	8 ÷ 6 HR...; HSV...	MH10/16-15
6 ÷ 16	10 ÷ 6 DR... (DIN 46235 style); DSV... (DIN 46267 T1 style)	MK5/8-15
10 ÷ 16	8 ÷ 6 ANE...; AN...; IN...; EN...	NN4-15
0,25 ÷ 6	22 ÷ 10 R...; B...; G...; PL...; NL...	RBG-15
0,25 ÷ 6	22 ÷ 10 R...; B...; G... (not suffix P, RF/BF-BF)	RBV-15 with positioner
0,3 ÷ 4	22 ÷ 12 PKE; PKC; PKD; PKT; KE	KE4-15
4 ÷ 16	12 ÷ 6 PKE; PKC; PKD; PKT; KE	KE16-15
16 ÷ 35	6 ÷ 2 PKE; PKC; PKD; PKT; KE	KE35-15
2,5 - 4 - 6	14 - 12 - 10 CS4 (for photovoltaic systems)	MCS4-15

18.0 V CORDLESS HYDRAULIC CRIMPING TOOL

general features

MAIN APPLICATIONS - max section sqmm

Section sqmm	0.25-1.5	1.5-2.5	4-6	10	16	25	35	50	70	95	120	150	185	240	300	400	500	630	800	1000	
L.V. lugs and splices																					
"C" sleeve Connectors																					

These tools are supplied without dies. For die selection, please refer to chart on pages 260 to 274

TECHNICAL FEATURES

Crimping force kN	50
Dimensions mm	
Length	364
Height	136
Width	81
Battery	18.0V 2.0Ah
Weight kg (with Battery)	2,6

STORAGE

Type	VAL-P22
Dimensions mm L x W x H	465 x 315 x 116
Weight kg	1,5
Supplied with the tool	✓



The tool is supplied as:

- Basic tool with battery and wrist strap
- Battery charger
- USB cable
- Plastic carrying case suitable for storing the tool and accessories



Wide-opening head, ideal for derivations from running conductors



B450ND-BV

Tool Type	Plug Type	Supplied Battery Charger Type
B450ND-BV	PLUG EU	ASC55-EU with EUROPEAN plug
B450ND-BVE	PLUG UK	ASC30-36-UK with UK plug
B450ND-BVA	PLUG USA CAN	ASC30-36-USA/CA (115V) with USA/ CANADA plug
B450ND-BVT	PLUG AU NZ	ASC30-36-AUS/NZ with AUSTRALIAN/ NEW ZEALAND plug



B450ND-BV is a new generation of hand-held cordless tools, characterised by a "Bilinear" mechanical design.

B450ND-BV is suitable for crimping electrical connectors onto conductor cross sections up to 150 mm² and uses the die sets common to all Cembre 45 kN tools and heads.

Equipped with Li-Ion 18.0V - 2.0Ah rechargeable high capacity batteries.

The battery is equipped with LED indicators to show the remaining battery life at any time by pressing the adjacent button.

Weight and balance have been reconfigured to yield improvements in handling and convenience.

Quieter operation, illumination of the working area via LED lights and a minimum of vibration enhance the tool's practicality.

It is also a feature that the operating data is stored on a memory card for transfer to PC by USB interface (SMARTOOL technology).

B500ND

18.0 V CORDLESS HYDRAULIC CRIMPING TOOL

general features

Tool Type	Plug Type	Supplied Battery Charger Type
B500ND	PLUG EU	ASC55-EU with EUROPEAN plug
B500NDE	PLUG UK	ASC30-36-UK with UK plug
B500NDA	PLUG USA CAN	ASC30-36-USA/CA (115V) with USA/CANADA plug
B500NDT	PLUG AU NZ	ASC30-36-AUS/NZ with AUSTRALIAN/NEW ZEALAND plug

60kN	Li-Ion 18.0V	SPEED
HEAD OPENING	180°	OLED
BATTERY DISPLAY	PROTECTED	ONE HAND
SAFETY	MAX PRESSURE	RELEASE
SILENT	SMOOTH	ERGONOMIC
BALANCED	LED LIGHTING	BI-COMPONENT
ENERGY SAVE	DURABLE	200k
-15°C +50°C	HEXAGONAL	RADIAL
INDENT	OVAL	CIRCULAR
CE	UK	CA

MAIN APPLICATIONS - max section sqmm

Section sqmm	0.25-1.5	1.5-2.5	4-6	10	16	25	35	50	70	95	120	150	185	200	240	300	400	500	630	800	1000	
L.V. lugs and splices																						
Insulated terminals																						
End sleeves																						
"C" sleeve Connectors																						
H.V. lugs and splices																						

These tools are supplied without dies. For die selection, please refer to chart on pages 260 to 274



B500ND is the first of a new generation of hand-held cordless tools, characterised by a "Bilinear" mechanical design. Equipped with a Smart Release system which automatically retracts the ram at the end of the operating cycle.

B500ND is suitable for crimping electrical connectors onto conductor cross sections up to 300 mm² and uses the die sets common to all Cembre 50kN tools and heads.

TECHNICAL FEATURES

Crimping force kN	60
Dimensions mm	
Length	396
Height	136
Width	81
Battery	18.0V 2.0Ah
Weight kg (with Battery)	3,15

STORAGE

Type	VAL-P22
Dimensions mm L x W x H	465 x 315 x 116
Weight kg	1,5
Supplied with the tool	✓



The tool is supplied as:

- Basic tool with battery and wrist strap
- Spare battery
- Battery charger
- USB cable
- Plastic carrying case suitable for storing the tool and accessories

KIT-B500ND-1

B500ND COMPRESSION KIT

The kit includes B500ND cordless hydraulic crimping tool (60 kN) complete with 8 die sets (from 25 to 185 mm²) and a practical and sturdy carrying case for the tool and its accessories.

The tool is supplied as:

- Basic tool with battery and wrist strap
- Spare battery
- Battery charger
- USB cable
- Plastic carrying case suitable for storing the tool and accessories



general features

KIT-B500ND-1

Kit includes:

- B500ND cordless hydraulic tool
- VALP22 plastic carrying case with accessories
- 8 die sets:

- ME5-50
- ME7-50
- ME10-50
- ME14-50
- ME19-50
- ME24-50
- ME30-50
- ME37-50

Hexagonal crimp for low voltage terminals and through connectors from 25 to 185 mm² A-M family

18.0 V CORDLESS HYDRAULIC CRIMPING TOOL

general features

MAIN APPLICATIONS - max section AWG

- Copper lugs and splices 300 MCM
- Aluminium lugs and splices 4/0
- Aluminium H taps 4/0 - 4/0

TECHNICAL FEATURES

Crimping force kN	54
Dimensions mm	
Length	495
Height	145
width	88
Battery	18.0V 2.0Ah
Weight kg (with Battery and CDD6N)	3,4

STORAGE

Type	VAL-P60
Dimensions mm L x W x H	620 x 360 x 138
Weight kg	2,4
Supplied with the tool	✓



The professional tool ideal for OH lines and residential service applications.

The tool is supplied as:

- Basic tool with jaws CDD6N, battery and wrist strap
- Spare battery
- Battery charger
- USB cable
- Plastic carrying case suitable for storing the tool and accessories



Tool Type	Plug Type	Supplied Battery Charger Type
B540ND6	PLUG EU	ASC55-EU with EUROPEAN plug
B540ND6E	PLUG UK	ASC30-36-UK with UK plug

54kN	Li-Ion 18.0V	SPEED
HEAD OPENING	180°	OLED
BATTERY DISPLAY	PROTECTED	ONE HAND
SAFETY	MAX PRESSURE	RELEASE
SILENT	SMOOTH	ERGONOMIC
BALANCED	LED LIGHTING	B+COMPONENT
ENERGY SAVE	DURABLE	200k
-15°C	+50°C	HEXAGONAL
CIRCULAR	CE	UK CA

B540ND6 is the first of a new generation of hand-held cordless tools, characterised by a "Bilinear" mechanical structure. Equipped with intelligent auto-return at the end of the operating cycle (Smart Release). Equipped with Li-Ion 18.0V - 2.0Ah rechargeable high capacity batteries. Jaws rotate by 180° for ease of operation in confined spaces.

Fitted with a maximum pressure sensor for enhanced precision and repeatability of the maximum pressure cycle, and a pressure relief valve providing additional safety for the operator.

Interchangeable Jaws

Many different Cembre interchangeable crimping and cutting jaws are available upon request .

CDD6N jaws



CMB4N jaws



CDD6-6N jaws



CMB5N jaws



CDD6-8N jaws



CMB6N jaws



INTERCHANGEABLE CRIMPING AND CUTTING JAWS

CAT.No	GROOVES	CRIMPING DIE COMPATIBILITY	
CDD6N	"D3" TO ACCEPT ALL "W" STYLE CRIMPING DIES + "BG" FIXED GROOVE	FCI Burndy	W, X Series
		Greenlee	KD6 Series
		IlSCO	ND Series
		Huskie	HT-58 Series
CDD6-6N	"D3" TO ACCEPT ALL "W" STYLE CRIMPING DIES	Panduit	CD-2001 series
		FCI Burndy	W, X Series
		Greenlee	KD6 Series
		IlSCO	ND Series
CDD6-8N	"D3" TO ACCEPT ALL "W" STYLE CRIMPING DIES + "O" FIXED GROOVE	Huskie	HT-58 Series
		Panduit	CD-2001 series
		FCI Burndy	W, X Series
		Greenlee	KD6 Series
CMB4N	Cutting jaws for underground: Aluminum & Copper stranded cables. Max opening 32 mm	IlSCO	ND Series
		Huskie	HT-58 Series
CMB5N	Cutting jaws for OHL: up to 200 mm ² ACSR and BLX cable	Panduit	CD-2001 series
CMB6N	Cutting jaws for guy wires: Up to Ø 10 mm galvanised steel wire (<1250N/mm ²)		

B500

18.0 V CORDLESS HYDRAULIC CRIMPING TOOL

general features

MAIN APPLICATIONS - max section sqmm

Section sqmm	0.25-1.5	1.5-2.5	4-6	10	16	25	35	50	70	95	120	150	185	200	240	300	400	500	630	800	1000	
L.V. lugs and splices																						
Insulated terminals																						
End sleeves																						
"C" sleeve Connectors																						
H.V. lugs and splices																						

These tools are supplied without dies. For die selection, please refer to chart on pages 260 to 274

Tool Type	Plug Type	Supplied Battery Charger Type
B500	PLUG EU	ASC55-EU with EUROPEAN plug
B500E	PLUG UK	ASC30-36-UK with UK plug
B500A	PLUG USA/CA	ASC30-36-USA/CA (115V) with USA/CANADA plug
B500T	PLUG AUS/NZ	ASC30-36-AUS/NZ with AUSTRALIAN/NEW ZEALAND plug

60kN

Li-Ion
18.0V

SPEED

HEAD OPENING

180°

OLED

BATTERY DISPLAY

PROTECTED

ONE HAND

SAFETY

MAX PRESSURE

RELEASE

SILENT

SMOOTH

ERGONOMIC

BALANCED

LED LIGHTING

BI-COMPONENT

ENERGY SAVE

DURABLE

200k

-15°C
+50°C

HEXAGONAL

RADIAL

INDENT

OVAL

CIRCULAR

CE

UK
CA



TECHNICAL FEATURES

Crimping force kN	63
Dimensions mm	
Length	300
Height	343
Width	83
Battery	18.0V 5.2Ah
Weight kg (with Battery)	4,2

STORAGE

Type	VAL-P38
Dimensions mm L x W x H	520 x 432 x 126
Weight kg	2,6
Supplied with the tool	✓



The tool is supplied as:

- Basic tool with battery and shoulder strap
- Spare battery
- Battery charger
- USB cable
- Plastic carrying case suitable for storing the tool and 14 die sets

The 63 kN B500 is suitable for a wide range of connectors up to 300 sqmm using die sets common to the Cembre 50 kN tooling range. Equipped with Li-Ion 18.0V - 5.2Ah rechargeable high capacity batteries.

The OLED display provides essential real time operating data, including:

- generated crimping force thus verifying accordance with best practice
- battery charge status
- general operating information
- the number of work cycles completed and remaining before recommended maintenance.



B500-KV version also available for Power Supply Companies

B500 COMPRESSION KIT

general features



KIT-B500-1 KIT-B500-2 KIT-B500-MK



KIT-B500-MK

Kit includes:

B500 cordless hydraulic tool	
VAL-P38 plastic carrying case with accessories	
10 die sets:	
MK8-50	Hexagonal crimp for low voltage terminals and through connectors from 16 to 240 mm ² DIN 46235 family
MK10-50	
MK14-50	
MK16-50	
MK18-50	
MK20-50	
MK22-50	
MK25-50	
MK28-50	

KIT-B500-1

Kit includes:

B500 cordless hydraulic tool	
VAL-P38 plastic carrying case with accessories	
8 die sets:	
ME5-50	Hexagonal crimp for low voltage terminals and through connectors from 25 to 185 mm ² A-M family
ME7-50	
ME10-50	
ME14-50	
ME19-50	
ME24-50	
ME30-50	
ME37-50	

KIT-B500-2

Kit includes:

B500 cordless hydraulic tool		
VAL-P38 plastic carrying case with accessories		
6 die sets:		
Nest	Indentor	Indent crimp for low voltage general purpose terminals and through connectors from 25 to 120 mm ²
MA5-50	PA5-50	
MA7-50	PA10-50	
MA10-50		
MA14-50	PA19-50	
MA19-50	PA24-50	

B600CND

18.0 V CORDLESS HYDRAULIC CRIMPING TOOL

general features

Tool Type	Plug Type	Supplied Battery Charger Type
B600CND	PLUG EU	ASC55-EU with EUROPEAN plug

MAIN APPLICATIONS - max section sqmm

Section sqmm	0.25-1.5	1.5-2.5	4-6	10	16	25	35	50	70	95	120	150	185	240	300	400	500	630	800	1000	
Cu DIN lugs and splices																					
L.V. lugs and splices																					
End sleeves																					

These tools are supplied without dies. For die selection, please refer to chart on pages 260 to 274

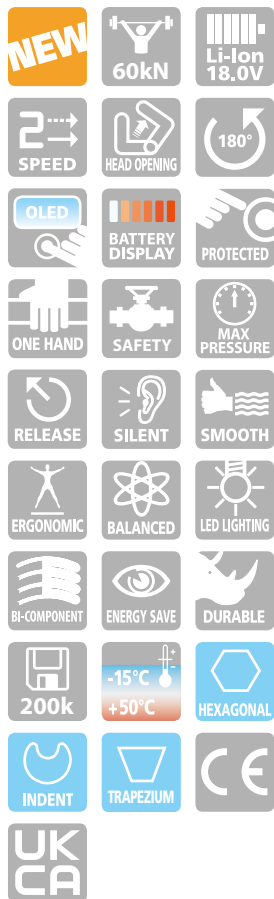

TECHNICAL FEATURES

Crimping force kN	60
Dimensions mm	
Length	398
Height	136
Width	81
Battery	18.0V 2.0Ah
Weight kg (with Battery)	3,15

STORAGE

Type	VAL-P63
Dimensions mm L x W x H	620 x 360 x 138
Weight kg	2,6
Supplied with the tool	✓



B600CND is a new generation of hand-held cordless tools, characterised by a "Bilinear" mechanical design.

Equipped with a Smart Release system which automatically retracts the ram at the end of the operating cycle.

B600CND is suitable for crimping electrical connectors onto conductor cross sections up to 300 mm². Equipped with Li-Ion 18.0V - 2.0Ah rechargeable high capacity batteries. Head rotate by 180° for ease of operation in confined spaces.

Fitted with a maximum pressure sensor for enhanced precision and repeatability of the maximum pressure cycle, and a pressure relief valve providing additional safety for the operator.

The EPS guarantees the precision of the crimping operation, checking the actual value of pressure and informing the operator about possible errors (EPS).

The OLED display provides essential real time operating data, including:

- generated crimping force thus verifying accordance with best practice
- battery charge status
- general operating information
- the number of work cycles completed and remaining before.

The tool is supplied as:

- Basic tool with battery and wrist strap
- Spare battery
- Battery charger
- USB cable
- Plastic carrying case suitable for storing the tool and accessories

18.0 V CORDLESS HYDRAULIC CRIMPING TOOL

B600C

general features

MAIN APPLICATIONS - max section sqmm

Section sqmm	0.25-1.5	1.5-2.5	4-6	10	16	25	35	50	70	95	120	150	185	240	300	400	500	630	800	1000	
Cu DIN lugs and splices																					
L.V. lugs and splices																					
End sleeves																					

These tools are supplied without dies. For die selection, please refer to chart on pages 260 to 274

TECHNICAL FEATURES

Crimping force kN	60
Dimensions mm	
Length	300
Height	350
Width	83
Battery	18.0V 5.2Ah
Weight kg (with Battery)	4,5

STORAGE

Type	VAL-P39
Dimensions mm L x W x H	520 x 432 x 126
Weight kg	2,6
Supplied with the tool	✓



The tool is supplied as:

- Basic tool with battery and shoulder strap
- Spare battery
- Battery charger
- USB cable
- Plastic carrying case suitable for storing the tool and accessories



Tool Type	Plug Type	Supplied Battery Charger Type
B600C	PLUG EU	ASC55-EU with EUROPEAN plug



The B600C is a new generation of portable cordless tools that are characterized by even better functionality. The B600C is suitable for crimping cable lugs and connectors up to 300 mm².

Equipped with Li-Ion 18.0V - 5.2Ah rechargeable high capacity batteries.

The OLED display provides essential real time operating data, including:

- generated crimping force thus verifying accordance with best practice
- battery charge status
- general operating information
- the number of work cycles completed and remaining before recommended maintenance.

B1350-C

18.0 V CORDLESS HYDRAULIC CRIMPING TOOL

general features

Tool Type	Plug Type	Supplied Battery Charger Type
B1350-C	PLUG EU	ASC55-EU with EUROPEAN plug
B1350-CE	PLUG UK	ASC30-36-UK with UK plug
B1350-CA	PLUG USA CAN	ASC30-36-USA/CA (115V) with USA/CANADA plug
B1350-CT	PLUG AUS NZ	ASC30-36-AUS/NZ with AUSTRALIAN/NEW ZEALAND plug

MAIN APPLICATIONS - max section sqmm

Section sqmm	0.25-1.5	1.5-2.5	4-6	10	16	25	35	50	70	95	120	150	185	200	240	300	400	500	630	800	1000	
L.V. lugs and splices																						
Insulated terminals																						
"C" sleeve Connectors																						
H.V. lugs																						
H.V. Splices*																						

*limited to the cable insulation diameter

These tools are supplied without dies. For die selection, please refer to chart on pages 260 to 274

UK CA



TECHNICAL FEATURES

Crimping force kN	132
Dimensions mm	
Length	338
Height	344
Width	83
Jaw Opening mm	25
Battery	18.0V 5.2Ah
Weight kg (with Battery)	6,5

STORAGE

Type	VAL-P39
Dimensions mm L x W x H	520 x 432 x 126
Weight kg	2,6
Supplied with the tool	✓



The tool is supplied as:

- Basic tool with battery and shoulder strap
- Spare battery
- Battery charger
- USB cable
- Plastic carrying case suitable for storing the tool and 8 die sets

B1350-C is suitable for a wide range of connectors up to 400 sqmm using die sets common to the Cembre 130 kN tooling range.

Equipped with Li-Ion 18.0V - 5.2Ah rechargeable high capacity batteries.

The OLED display provides essential real time operating data, including:

- generated crimping force thus verifying accordance with best practice
- battery charge status
- general operating information
- the number of work cycles completed and remaining before recommended maintenance.



B1350-C-KV version also available for Power Supply Companies

18.0 V CORDLESS HYDRAULIC CRIMPING TOOL

general features

MAIN APPLICATIONS - max section sqmm

Section sqmm	0.25±1.5	1.5±2.5	4-6	10	16	25	35	50	70	95	120	150	185	200	240	300	400	500	630	800	1000	
L.V. lugs and splices																						
Insulated terminals																						
"C" sleeve Connectors																						
H.V. lugs and splices																						

These tools are supplied without dies. For die selection, please refer to chart on pages 260 to 274

TECHNICAL FEATURES

Crimping force kN	132
Dimensions mm	
Length	395
Height	372
Width	83
Jaw Opening mm	42
Battery	18.0V 5.2Ah
Weight kg (with Battery)	8,1

STORAGE

Type	VAL-P39
Dimensions mm L x W x H	520 x 432 x 126
Weight kg	2,6
Supplied with the tool	✓



The tool is supplied as:

- Basic tool with battery and shoulder strap
- Spare battery
- Battery charger
- USB cable
- Plastic carrying case suitable for storing the tool and 8 die sets



B1350L-C version, featuring a large 42 mm jaw opening, for an easier introduction/removal of large size compression terminations and joints.



B1350L-C-KV version also available for Power Supply Companies

B1350L-C

Tool Type	Plug Type	Supplied Battery Charger Type
B1350L-C	PLUG EU	ASC55-EU with EUROPEAN plug
B1350L-CE	PLUG UK	ASC30-36-UK with UK plug
B1350L-CA	PLUG USA CAN	ASC30-36-USA/CA (115V) with USA/CANADA plug
B1350L-CT	PLUG AUS NZ	ASC30-36-AUS/NZ with AUSTRALIAN/NEW ZEALAND plug



B1350L-C is suitable for a wide range of connectors up to 400 sqmm using die sets common to the Cembre 130 kN tooling range. Equipped with Li-Ion 18.0V - 5.2Ah rechargeable high capacity batteries.

The OLED display provides essential real time operating data, including:

- generated crimping force thus verifying accordance with best practice
- battery charge status
- general operating information
- the number of work cycles completed and remaining before recommended maintenance.

B1350-UC

18.0 V CORDLESS HYDRAULIC CRIMPING TOOL

general features

MAIN APPLICATIONS - max section sqmm

Section sqmm	0.25+-1.5	1.5+-2.5	4-6	10	16	25	35	50	70	95	120	150	185	200	240	300	400	500	680	800	1000	
L.V. lugs and splices																						
Insulated terminals																						
"C" sleeve Connectors																						
Alu lugs and splices																						
H.V. lugs and splices																						

These tools are supplied without dies. For die selection, please refer to chart on pages 260 to 274

Tool Type	Plug Type	Supplied Battery Charger Type
B1350-UC	PLUG EU	ASC55-EU with EUROPEAN plug
B1350-UC-E	PLUG UK	ASC30-36-UK with UK plug
B1350-UC-A	PLUG USA	ASC30-36-USA/CA (115V) with USA/CANADA plug
B1350-UC-T	PLUG AU	ASC30-36-AUS/NZ with AUSTRALIAN/NEW ZEALAND plug



TECHNICAL FEATURES

Crimping force kN	132
Dimensions mm	
Length	351
Height	369
Width	83
Battery	18.0V 5.2Ah
Weight kg (with Battery)	6,3

STORAGE

Type	VAL-P39
Dimensions mm L x W x H	520 x 432 x 126
Weight kg	2,6
Supplied with the tool	✓



The tool is supplied as:

- Basic tool with battery and shoulder strap
- Spare battery
- Battery charger
- USB cable
- Plastic carrying case suitable for storing the tool and 8 die sets

STORAGE

Type	VAL-130*
Dimensions mm L x W x H	360 x 280 x 48
Weight kg	3,0
Purchase separately	✓

*Suitable for the storage of accessories for crimping Aluminium connectors



VAL-130

B1350-UC will accept the accessories for performing the "Deep Stepped Indent" system of crimping on Aluminium cables. The B1350-UC will accept all semi-circular slotted dies, common to most 12 tons tools (U dies). Equipped with Li-Ion 18.0V - 5.2Ah rechargeable high capacity batteries.

The OLED display provides essential real time operating data, including:

- generated crimping force thus verifying accordance with best practice
- battery charge status
- general operating information
- the number of work cycles completed and remaining before recommended maintenance.

18.0 V CORDLESS HYDRAULIC CRIMPING TOOL

B1300-C

general features

MAIN APPLICATIONS - max section sqmm

Section sqmm	0.25-1.5	1.5-2.5	4-6	10	16	25	35	50	70	95	120	150	185	200	240	300	400	500	630	800	1000	
L.V. lugs and splices																						
Insulated terminals																						
"C" sleeve Connectors																						
H.V. lugs																						
H.V. Splices*																						

*limited to the cable insulation diameter

These tools are supplied without dies. For die selection, please refer to chart on pages 260 to 274

TECHNICAL FEATURES

Crimping force kN	132
Dimensions mm	
Length	406
Height	239
Width	102,5
Jaw Opening mm	25
Battery	18.0V 5.2Ah
Weight kg (with Battery)	6,8

STORAGE

Type	VAL-P44
Dimensions mm L x W x H	680 x 473 x 151
Weight kg	3,7
Supplied with the tool	✓



The tool is supplied as:

- Basic tool with battery and shoulder strap
- Spare battery
- Battery charger
- USB cable
- Plastic carrying case suitable for storing the tool and 12 die sets

B1300-C is suitable for a wide range of connectors up to 400 sqmm using die sets common to the Cembre 130 kN tooling range. Equipped with Li-Ion 18.0V - 5.2Ah rechargeable high capacity batteries.



B1300-C-KV version also available for Power Supply Companies

Tool Type	Plug Type	Supplied Battery Charger Type
B1300-C	PLUG EU	ASC55-EU with EUROPEAN plug
B1300-CE	PLUG UK	ASC30-36-UK with UK plug
B1300-CA	PLUG USA CAN	ASC30-36-USA/CA (115V) with USA/ CANADA plug
B1300-CT	PLUG AUZ NZ	ASC30-36-AUS/NZ with AUSTRALIAN/ NEW ZEALAND plug

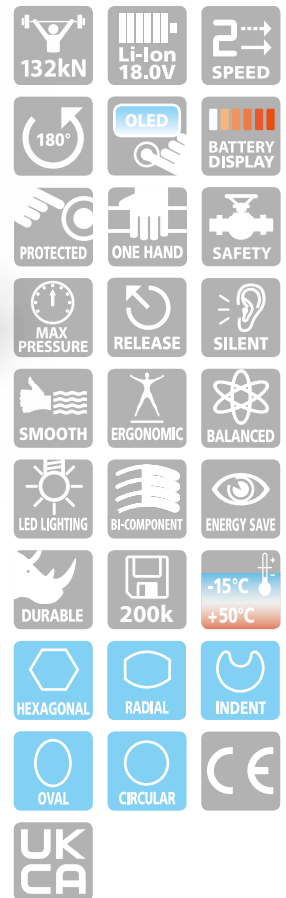

B1300-C COMPRESSION KIT

general features

KIT-B1300-C-1 KIT-B1300-C-2 KIT-B1300-C-MK



KIT-B1300-C-1

Kit includes:

B1300-C cordless hydraulic tool	
VAL-P44 plastic carrying case with accessories	
7 die sets:	
ME10-C	Hexagonal crimp for low voltage terminals and through connectors from 50 to 240 mm ² A-M family
ME14-C	
ME19-C	
ME24-C	
ME30-C	
ME37-C	
ME48-C	

KIT-B1300-C-2

Kit includes:

B1300-C cordless hydraulic tool		
VAL-P44 plastic carrying case with accessories		
11 die sets:		
Nest	Indentor	Indent crimp for low voltage general purpose terminals and through connectors from 10 to 240 mm ²
MA2-C		
MA3-C		
MA5-C	PA10-C	
MA7-C		
MA10-C		
MA14-C		
MA19-C	PA24-C	
MA24-C		
MA30-C		
MA37-C	PA48-C	
MA48-C		

KIT-B1300-C-MK

Kit includes:

B1300-C cordless hydraulic tool	
VAL-P44 plastic carrying case with accessories	
11 die sets:	
MK6-C	Hexagonal crimp for low voltage terminals and through connectors from 10 to 240 mm ² DIN 46235 family
MK8-C	
MK10-C	
MK12-C	
MK14-C	
MK16-C	
MK18-C	
MK20-C	
MK22-C	
MK25-C	
MK28-C	

B1300L-C

18.0 V CORDLESS HYDRAULIC CRIMPING TOOL

general features

MAIN APPLICATIONS - max section sqmm

Section sqmm	0.25-1.5	1.5-2.5	4-6	10	16	25	35	50	70	95	120	150	185	200	240	300	400	500	630	800	1000	
L.V. lugs and splices																						
Insulated terminals																						
"C" sleeve Connectors																						
H.V. lugs and splices																						

These tools are supplied without dies. For die selection, please refer to chart on pages 260 to 274

Tool Type	Plug Type	Supplied Battery Charger Type
B1300L-C	PLUG EU	ASC55-EU with EUROPEAN plug
B1300L-CE	PLUG UK	ASC30-36-UK with UK plug
B1300L-CA	PLUG USA	ASC30-36-USA/CA (115V) with USA/CANADA plug
B1300L-CT	PLUG AU/NZ	ASC30-36-AUS/NZ with AUSTRALIAN/NEW ZEALAND plug



TECHNICAL FEATURES

Crimping force kN	132
Dimensions mm	
Length	471
Height	239
Width	102,5
Jaw Opening mm	42
Battery	18.0V 5.2Ah
Weight kg (with Battery)	8,0

STORAGE

Type	VAL-P44
Dimensions mm L x W x H	680 x 473 x 151
Weight kg	3,7
Supplied with the tool	✓



The tool is supplied as:

- Basic tool with battery and shoulder strap
- Spare battery
- Battery charger
- USB cable
- Plastic carrying case suitable for storing the tool and 12 die sets



B1300L-C-KV version also available for Power Supply Companies

The B1300L-C version, featuring a large 42 mm jaw opening, for an easier introduction/removal of large size compression terminations and joints.

B1300L-C is suitable for a wide range of connectors up to 400 sqmm using die sets common to the Cembre 130 kN tooling range. Equipped with Li-Ion 18.0V - 5.2Ah rechargeable high capacity batteries.

The OLED display provides essential real time operating data, including:

- generated crimping force thus verifying accordance with best practice
- battery charge status
- general operating information
- the number of work cycles completed and remaining before recommended maintenance.

18.0 V CORDLESS HYDRAULIC CRIMPING TOOL

general features

MAIN APPLICATIONS - max section sqmm

Section sqmm	0.25÷1.5	1.5÷2.5	4÷6	10	16	25	35	50	70	95	120	150	185	200	240	300	400	500	630	800	1000	
L.V. lugs and splices																						
Insulated terminals																						
"C" sleeve Connectors																						
Alu lugs and splices																						
H.V. lugs and splices																						

These tools are supplied without dies. For die selection, please refer to chart on pages 260 to 274

TECHNICAL FEATURES

Crimping force kN	132
Dimensions mm	
Length	423
Height	239
Width	102,5
Battery	18.0V 5.2Ah
Weight kg (with Battery)	6,5



STORAGE

Type	VAL-P44
Dimensions mm L x W x H	680 x 473 x 151
Weight kg	3,7
Supplied with the tool	✓



The tool is supplied as:

- Basic tool with battery and shoulder strap
- Spare battery
- Battery charger
- USB cable
- Plastic carrying case suitable for storing the tool and 12 die sets

STORAGE

Type	VAL-130*
Dimensions mm L x W x H	360 x 280 x 48
Weight kg	3,0
Purchase separately	✓

*Suitable for the storage of accessories for crimping Aluminium connectors



VAL-130

B1300-UC

Tool Type	Plug Type	Supplied Battery Charger Type
B1300-UC	PLUG EU	ASC55-EU with EUROPEAN plug
B1300-UC-E	PLUG UK	ASC30-36-UK with UK plug
B1300-UCA	PLUG USA	ASC30-36-USA/CA (115V) with USA/CANADA plug
B1300-UCT	PLUG NZ AUS	ASC30-36-AUS/NZ with AUSTRALIAN/NEW ZEALAND plug



B1300-UC will accept the accessories for performing the "Deep Stepped Indent" system of crimping on Aluminium cables.

The B1300-UC will accept all semi-circular slotted dies, common to most 12 tons tools (U dies).

Equipped with Li-Ion 18.0V - 5.2Ah rechargeable high capacity batteries.

The OLED display provides essential real time operating data, including:

- generated crimping force thus verifying accordance with best practice
- battery charge status
- general operating information
- the number of work cycles completed and remaining before recommended maintenance.

B-TC250ND

18.0 V CORDLESS HYDRAULIC CUTTING TOOL

overhead line application

MAIN APPLICATIONS

specifically designed to cut Copper, aldrej, Aluminium, Aluminium-Steel cables and Steel ropes, Aluminium and Steel rods having Ø max 25 mm

Tool Type	Plug Type	Supplied Battery Charger Type
B-TC250ND	PLUG EU	ASC55-EU with EUROPEAN plug
B-TC250NDE	PLUG UK	ASC30-36-UK with UK plug
B-TC250YNDA	PLUG USA CAN	ASC30-36-USA/CA (115V) with USA/CANADA plug
B-TC250NDT B-TC250YNDT	PLUG AUS NZ	ASC30-36-AUS/NZ with AUSTRALIAN/NEW ZEALAND plug



TECHNICAL FEATURES

Max cutting Ø mm	25
Dimensions mm	
Length	401
Height	136
Width	81
Battery	18.0V 2.0Ah
Weight kg (with Battery)	3,5

STORAGE

Type	VAL-P22
Dimensions mm L x W x H	465 x 315 x 116
Weight kg	1,5
Supplied with the tool	✓



B-TC250ND is a new generation of hand-held cordless tools, characterised by a "Bilinear" mechanical design.

B-TC250ND is specifically designed to cut Copper, aldrej, Aluminium, Aluminium-Steel cables and Steel ropes, Aluminium and Steel rods having a max overall diameter of 25 mm.

The blades are manufactured from high strength special Steel, heat treated to ensure a long service life. New Li-Ion 18.0V - 2.0Ah batteries offer a higher capacity, while greater cutting speed and cutting force result from a revitalised hydraulic system with double speed action.

The battery is equipped with led indicators that indicate the remaining battery life at any time by pressing the adjacent button.

Quieter operation, illumination of the working area via LED lights and a minimum of vibration enhance the tool's practicality. Two batteries and charger included.

Same charger of all our tools. Operating temperature: -15 to +50 °C

The tool is supplied as:

- Basic tool with battery and wrist strap
- Spare battery
- Battery charger
- USB cable
- Plastic carrying case suitable for storing the tool and accessories

CUTTING CAPACITY - a few examples

	MATERIAL	TENSILE STRENGTH (daN/mm ²)	MAX CUTTING DIAMETER (mm)		
			B-TC250ND B-TC250YNDA	B-TC250NDE B-TC250NDT	B-TC250YNDT
ROPE & CONDUCTORS	COPPER	≤ 41	25		
	ALUMINIUM	≤ 20	25		
	ALMELEC	≤ 34	25		
	STEEL	≤ 180	INDICATIVE EXAMPLES: 7 x 3,0 : Ø est. = 9,0 mm 19 x 2,1 : Ø est. = 10,5 mm 19 x 2,3 : Ø est. = 11,5 mm		
	MULTI STRANDS STEEL (STRANDS Qty ≥ 200)	≤ 180	18		
	ACSR	≤ 180	25 INDICATIVE EXAMPLES: 26 x 2,50 + 7 x 1,95 : Ø est. = 15,85 26 x 3,06 + 7 x 2,38 : Ø est. = 19,38 26 x 3,60 + 7 x 2,80 : Ø est. = 22,80		
RODS	STEEL	≤ 60	13		
		≤ 42	16		
	COPPER	≤ 30	20		
		≤ 25	23		
	ALUMINIUM	≤ 16	25		

18.0 V CORDLESS HYDRAULIC CUTTING TOOL

overhead line application

MAIN APPLICATIONS

specifically designed to cut Copper, aldrej, Aluminium, Aluminium-Steel cables and Steel ropes, Aluminium and Steel rods having Ø max 32 mm

TECHNICAL FEATURES

Max cutting Ø mm	32
Dimensions mm	
Length	444
Height	136
Width	81
Battery	18.0V 2.0Ah
Weight kg (with Battery)	3,95

STORAGE

Type	VAL-P48
Dimensions mm L x W x H	620 x 360 x 138
Weight kg	2,4
Supplied with the tool	✓



The tool is supplied as:

- Basic tool with battery and wrist strap
- Spare battery
- Battery charger
- USB cable
- Plastic carrying case suitable for storing the tool and accessories



CUTTING CAPACITY - a few examples

Section mm ²	Ø mm	Stranding	Cable Type
120	13,3 mm	-	RIM120
50	8,9	7 x 2,95 mm	Bronze
70	10,3	19 x 2,06 mm	Bronze
95	12,5	19 x 2,50 mm	Bronze
70	10,7	19/2,14	Aluminium
95	12,5	19/2,5	Aluminium
150	15,75	37/2,25	Aluminium
323	23,25	19/4,65	Aluminium
415	-	37/3,78	Aluminium
35/6	8,1	6/2,70 + 1/2,70	Aluminium-steel
50/8	9,6	6/3,20 + 1/3,20	Aluminium-steel
50/30	11,7	12/2,33 + 7/2,33	Aluminium-steel
70/12	11,6	26/1,85 + 7/1,44	Aluminium-steel
95/15	13,4	26/2,15 + 7/1,67	Aluminium-steel
150/25	17,3	26/2,70 + 7/2,10	Aluminium-steel
170/40	18,95	30/2,79 + 7/2,79	Aluminium-steel
185/30	19,0	26/3,00 + 7/2,33	Aluminium-steel
230/30	21,0	24/3,5 + 7/2,33	Aluminium-steel
240/40	21,9	26/3,45 + 7/2,68	Aluminium-steel
495/35	29,9	45/3,74 + 7/2,49	Aluminium-steel
297,7 (OSPREY)	22,33	18/4,47 + 1/4,47	Aluminium-steel
327,9 (DOVE)	23,55	26/3,72 + 7/2,84	Aluminium-steel
239	20,1	37/2,87	Rope Aluminium Alloy
50	11,0	Class 5	Aluminium flex
95	18,5 mm	-	Steel flex
153	16,0	19/3,2	Cu
70	19,5	2214/0,2	Cu extra flex
16	9,0	126/0,4	Cu flex
120	19,9	608/0,5	Cu flex
240	-	1221/0,5	Cu flex

B-TC320ND

Tool Type	Plug Type	Supplied Battery Charger Type
B-TC320ND	PLUG EU	ASC55-EU with EUROPEAN plug
B-TC320NDE	PLUG UK	ASC30-36-UK with UK plug
B-TC320NDA	PLUG USA CAN	ASC30-36-USA/CA (115V) with USA/CANADA plug
B-TC320NDT	PLUG AUZ	ASC30-36-AUS/NZ with AUSTRALIAN/NEW ZEALAND plug



B-TC320ND is a new generation of hand-held cordless tools, characterised by a "Bilinear" mechanical design.

B-TC320ND is specifically designed to cut Copper, aldrej, Aluminium, Aluminium-Steel cables and Steel ropes, Aluminium and Steel rods having a max overall diameter of 32 mm.

The blades are manufactured from high strength special Steel, heat treated to ensure a long service life. New Li-Ion 18.0V - 2.0Ah batteries offer a higher capacity, while greater cutting speed and cutting force result from a revitalised hydraulic system with double speed action.

The battery is equipped with led indicators that indicate the remaining battery life at any time by pressing the adjacent button. Quieter operation, illumination of the working area via LED lights and a minimum of vibration enhance the tool's practicality.

Two batteries and charger included.

Same charger of all our tools. Operating temperature: -15 to +50 °C

B-TC250

18.0 V CORDLESS HYDRAULIC CUTTING TOOL

overhead line application

MAIN APPLICATIONS

specifically designed to cut Copper, aldrej, Aluminium, Aluminium-Steel cables and Steel ropes, Aluminium and Steel rods having Ø max 25 mm

Tool Type	Plug Type	Supplied Battery Charger Type
B-TC250	PLUG EU	ASC55-EU with EUROPEAN plug
B-TC250E	PLUG UK	ASC30-36-UK with UK plug
B-TC250YA	PLUG USA CAN	ASC30-36-USA/CA (115V) with USA/ CANADA plug
B-TC250T	PLUG AUS NZ	ASC30-36-AUS/NZ with AUSTRALIAN/ NEW ZEALAND plug



TECHNICAL FEATURES

Max cutting Ø mm	25
Dimensions mm	
Length	300
Height	337
Width	83
Battery	18.0V 5.2Ah
Weight kg (with Battery)	4,65

STORAGE

Type	VAL-P40
Dimensions mm L x W x H	520 x 432 x 126
Weight kg	2,6
Supplied with the tool	✓



The tool is supplied as:

- Basic tool with battery and shoulder strap
- Spare battery
- Battery charger
- USB cable
- Plastic carrying case suitable for storing the tool and accessories

Next generation of 18.0 V cordless hydraulic cutting tool specifically designed to cut Copper, aldrej, Aluminium, Aluminium-Steel cables and Steel ropes, Aluminium and Steel rods having a max overall diameter of 25 mm.

The blades are manufactured from high strength special Steel, heat treated to ensure a long service life.

New Li-Ion 18.0V - 5.2Ah batteries offer a higher capacity, while greater cutting speed and cutting force result from a revitalised hydraulic system with double speed action.

The battery is equipped with LED indicators to show the remaining battery life at any time by pressing the adjacent button.

The head can rotate through 180 degrees, to enable the operator to work in the most comfortable position, and can easily be opened to allow cutting of running cables. Rubber grip inserts, low noise and minimal vibration aid operator comfort while additional convenience and safety are provided by LED lighting of the working area. Operating temperature: -15 to +50 °C

CUTTING CAPACITY - a few examples

	MATERIAL	TENSILE STRENGTH (daN/mm ²)	MAX CUTTING DIAMETER (mm)	
			B-TC250 B-TC250YA	B-TC250E B-TC250T
ROPE & CONDUCTORS	COPPER	≤ 41	25	
	ALUMINIUM	≤ 20	25	
	ALMELEC	≤ 34	25	
	STEEL	≤ 180	INDICATIVE EXAMPLES: 7 x 3,0 : Ø est. = 9,0 mm 19 x 2,1 : Ø est. = 10,5 mm 19 x 2,3 : Ø est. = 11,5 mm	
	MULTI STRANDS STEEL (STRANDS Qty ≥ 200)	≤ 180	18	
	ACSR	≤ 180	25 INDICATIVE EXAMPLES: 26 x 2,50 + 7 x 1,95 : Ø est. = 15,85 26 x 3,06 + 7 x 2,38 : Ø est. = 19,38 26 x 3,60 + 7 x 2,80 : Ø est. = 22,80	
RODS	STEEL	≤ 60	13	
		≤ 42	16	
	COPPER	≤ 30	20	
		≤ 25	23	
	ALUMINIUM	≤ 16	25	

18.0 V CORDLESS HYDRAULIC CUTTING TOOL

overhead line application

B-TC450

MAIN APPLICATIONS

specifically designed to cut Copper, aldrej, Aluminium, Aluminium-Steel cables and Steel ropes, Aluminium and Steel rods having Ø max 45 mm

TECHNICAL FEATURES

Max cutting Ø mm	45
Dimensions mm	
Length	407
Height	401
Width	88
Battery	18.0V 5.2Ah
Weight kg (with Battery)	6,7

STORAGE

Type	VAL-P40
Dimensions mm L x W x H	520 x 432 x 126
Weight kg	2,6
Supplied with the tool	✓



The tool is supplied as:

- Basic tool with battery and shoulder strap
- Spare battery
- Battery charger
- USB cable
- Plastic carrying case suitable for storing the tool and accessories

Tool Type	Plug Type	Supplied Battery Charger Type
B-TC450	PLUG EU	ASC55-EU with EUROPEAN plug
B-TC450E	PLUG UK	ASC30-36-UK with UK plug
B-TC450A	PLUG USA CAN	ASC30-36-USA/CA (115V) with USA/ CANADA plug

- Ø 45mm
- Li-Ion 18.0V
- SPEED
- HEAD OPENING
- SPECIAL
- 180°
- BATTERY DISPLAY
- PROTECTED
- ONE HAND
- SAFETY
- RELEASE
- SILENT
- SMOOTH
- ERGONOMIC
- BALANCED
- LED LIGHTING
- BI-COMPONENT
- ENERGY SAVE
- DURABLE
- 200k
- 15°C
- +50°C
- CE
- UK CA

CUTTING CAPACITY - a few examples

	MATERIAL	TENSILE STRENGTH (daN/mm ²)	MAX CUTTING DIAMETER (mm)	
			B-TC450	B-TC450E B-TC450A
ROPE & CONDUCTORS	COPPER	≤ 41	45	
	ALUMINIUM	≤ 20	45	
	ALMELEC	≤ 34	45	
	STEEL	≤ 180	INDICATIVE EXAMPLES: 7 x 3,0 : Ø est. = 9,0 mm 19 x 2,1 : Ø est. = 10,5 mm 19 x 2,3 : Ø est. = 11,5 mm	
	MULTI STRANDS STEEL (STRANDS Qty ≥ 200)	≤ 180	18	
RODS	ACSR	≤ 180	45 INDICATIVE EXAMPLES: 26 x 2,50 + 7 x 1,95 : Ø est. = 15,85 26 x 3,06 + 7 x 2,38 : Ø est. = 19,38 26 x 3,60 + 7 x 2,80 : Ø est. = 22,80 54 x 3,50 + 19 x 2,10 : Ø est. = 31,50 54 x 4,36 + 19 x 2,62 : Ø est. = 39,20	
	STEEL	≤ 60	18	
		≤ 42	20	
	COPPER	≤ 30	30	
		≤ 25	32	
	ALUMINIUM	≤ 16	45	

Next generation of 18.0 V cordless hydraulic cutting tool specifically designed to cut Copper, aldrej, Aluminium, Aluminium-Steel cables and Steel ropes, Aluminium and Steel rods having a max overall diameter of 45 mm.

The blades are manufactured from high strength special Steel, heat treated to ensure a long service life.

New Li-Ion 18.0V - 5.2Ah batteries offer a higher capacity, while greater cutting speed and cutting force result from a revitalised hydraulic system with double speed action.

The battery is equipped with LED indicators to show the remaining battery life at any time by pressing the adjacent button.

The head can rotate through 180 degrees, to enable the operator to work in the most comfortable position, and can easily be opened to allow cutting of running cables.

Rubber grip inserts, low noise and minimal vibration aid operator comfort while additional convenience and safety are provided by LED lighting of the working area.

Operating temperature:

-15 to +50 °C

B-TC500Y

18.0 V CORDLESS HYDRAULIC CUTTING TOOL

overhead line application

MAIN APPLICATIONS

specifically designed to cut Copper, Aluminum, Aluminum-Steel cables (ACSR) having Ø max 50 mm

Not suitable for cutting stay wire, Steel rope or earthing rod

Tool Type	Plug Type	Supplied Battery Charger Type
B-TC500Y	PLUG EU	ASC55-EU with EUROPEAN plug
B-TC500YE	PLUG UK	ASC30-36-UK with UK plug
B-TC500YA	PLUG USA	ASC30-36-USA/CA (115V) with USA/CANADA plug



TECHNICAL FEATURES

Max cutting Ø mm	50
Dimensions mm	
Length	405
Height	398
Width	83
Battery	18.0V 5.2Ah
Weight kg (with Battery)	5,8

STORAGE

Type	VAL-P40
Dimensions mm L x W x H	520 x 432 x 126
Weight kg	2,6
Supplied with the tool	✓



The tool is supplied as:

- Basic tool with battery and shoulder strap
- Spare battery
- Battery charger
- USB cable
- Plastic carrying case suitable for storing the tool and accessories

Next generation of 18.0 V cordless hydraulic cutting tool specifically designed to cut Copper, Aluminum, Aluminum-Steel cables (ACSR) having a max overall diameter of 50 mm. The blades are manufactured from high strength special Steel, heat treated to ensure a long service life.

New Li-Ion 18.0V - 5.2Ah batteries offer a higher capacity, while greater cutting speed and cutting force result from a revitalised hydraulic system with double speed action.

The battery is equipped with LED indicators to show the remaining battery life at any time by pressing the adjacent button.

The head can rotate through 90 degrees, to enable the operator to work in the most comfortable position, and can easily be opened to allow cutting of running cables.

Rubber grip inserts, low noise and minimal vibration aid operator comfort while additional convenience and safety are provided by LED lighting of the working area.

Operating temperature: -15 to +50 °C

18.0 V CORDLESS HYDRAULIC CUTTING TOOL

overhead line application

MAIN APPLICATIONS

specifically designed to cut Copper, Alredy, Aluminium, Aluminium-Steel cables and Steel ropes, Aluminium and Steel rods having Ø max 55 mm

TECHNICAL FEATURES

Max cutting Ø mm	55
Dimensions mm	
Length	441
Height	424
Width	87
Battery	18.0V 5.2Ah
Weight kg (with Battery)	8,9

STORAGE

Type	VAL-P40
Dimensions mm L x W x H	520 x 432 x 126
Weight kg	2,6
Supplied with the tool	✓



The tool is supplied as:

- Basic tool with battery and shoulder strap
- Spare battery
- Battery charger
- USB cable
- Plastic carrying case suitable for storing the tool and accessories

CUTTING CAPACITY - a few examples

	MATERIAL	TENSILE STRENGTH (daN/mm²)	MAX CUTTING DIAMETER (mm)	
			B-TC550 B-TC550A	B-TC550E B-TC550T
ROPE & CONDUCTORS	COPPER	≤ 41	55	
	ALUMINIUM	≤ 20	55	
	ALMELEC	≤ 34	55	
	STEEL	≤ 180	INDICATIVE EXAMPLES: 7 x 3,0 : Ø est. = 9,0 mm 19 x 2,1 : Ø est. = 10,5 mm 19 x 2,3 : Ø est. = 11,5 mm	
	MULTI STRANDS STEEL (STRANDS Qty ≥ 200)	≤ 180	22	
	ACSR	≤ 180	50 INDICATIVE EXAMPLES: 26 x 2,50 + 7 x 1,95 : Ø est. = 15,85 26 x 3,06 + 7 x 2,38 : Ø est. = 19,38 26 x 3,60 + 7 x 2,80 : Ø est. = 22,80 26 x 4,44 + 7 x 3,45 : Ø est. = 28,14 54 x 3,50 + 19 x 2,10 : Ø est. = 31,50 54 x 4,36 + 19 x 2,62 : Ø est. = 39,20 83 x 4,60 + 16 x 2,80 : Ø est. = 50,00	
	GUY WIRE (GW15-9/16-188)	Extra high strength grade	7 x 4,77 : Ø est. = 14,30 mm	
RODS	STEEL	≤ 60	20	
		≤ 42	22	
	COPPER	≤ 30	34	
		≤ 25	38,5	
	ALUMINIUM	≤ 16	50	

B-TC550

Tool Type	Plug Type	Supplied Battery Charger Type
B-TC550	PLUG EU	ASC55-EU with EUROPEAN plug
B-TC550E	PLUG UK	ASC30-36-UK with UK plug
B-TC550A	PLUG USA	ASC30-36-USA/CA (115V) with USA/ CANADA plug
B-TC550T	PLUG AU/NZ	ASC30-36-AUS/NZ with AUSTRALIAN/ NEW ZEALAND plug



Next generation of 18.0 V cordless hydraulic cutting tool. Specifically designed to cut Copper, Alredy, Aluminium, Aluminium-Steel cables and Steel ropes, Aluminium and Steel rods having a max overall diameter of 55 mm.

The blades are manufactured from high strength special Steel, heat treated to ensure a long service life.

New Li-Ion 18.0V - 5.2Ah batteries offer a higher capacity, while greater cutting speed and cutting force result from a revitalised hydraulic system with double speed action. The battery is equipped with LED indicators to show the remaining battery life at any time by pressing the adjacent button.

The head can rotate through 330 degrees, to enable the operator to work in the most comfortable position, and can easily be opened to allow cutting of running cables.

Rubber grip inserts, low noise and minimal vibration aid operator comfort while additional convenience and safety are provided by LED lighting of the working area.

Operating temperature:

-15 to +50 °C

B-TC320NDF

18.0 V CORDLESS HYDRAULIC CUTTING TOOL

industrial application

MAIN APPLICATIONS

specifically designed to cut Copper, Aluminium and Telecommunications cable having Ø max 32 mm

Tool Type	Plug Type	Supplied Battery Charger Type
B-TC320NDF	PLUG EU	ASC55-EU with EUROPEAN plug
B-TC320NDFE	PLUG UK	ASC30-36-UK with UK plug
B-TC320NDFEA	PLUG USA CAN	ASC30-36-USA/CA (115V) with USA/CANADA plug
B-TC320NDFT	PLUG AUS NZ	ASC30-36-AUS/NZ with AUSTRALIAN/NEW ZEALAND plug



TECHNICAL FEATURES

Max cutting Ø mm	32
Dimensions mm	
Length	444
Height	136
Width	81
Battery	18.0V 2.0Ah
Weight kg (with Battery)	4,0

STORAGE

Type	VAL-P48
Dimensions mm L x W x H	620 x 360 x 138
Weight kg	2,4
Supplied with the tool	✓



B-TC320NDF is a new generation of hand-held cordless tools, characterised by a "Bilinear" mechanical design.

B-TC320NDF is specifically designed to cut Copper, Aluminium and telecommunication cable having a max overall diameter of 32 mm.

The blades are manufactured from high strength special Steel, heat treated to ensure a long service life. New Li-Ion 18.0V - 2.0Ah batteries offer a higher capacity, while greater cutting speed and cutting force result from a revitalised hydraulic system with double speed action.

The battery is equipped with led indicators that indicate the remaining battery life at any time by pressing the adjacent button.

The head can rotate through 180

degrees, to enable the operator to work in the most comfortable position, and can easily be opened to allow cutting of running cables.

Quieter operation, illumination of the working area via LED lights and a minimum of vibration enhance the tool's practicality.

Two batteries and charger included.

Same charger of all our tools.

Operating temperature:

-15 to +50 °C

The tool is supplied as:

- Basic tool with battery and wrist strap
- Spare battery
- Battery charger
- USB cable
- Plastic carrying case suitable for storing the tool and accessories

18.0 V CORDLESS HYDRAULIC CUTTING TOOL

industrial application

MAIN APPLICATIONS

specifically designed to cut Copper, Aluminium and Telecommunications cable having Ø max 52,5 mm

TECHNICAL FEATURES

Max cutting Ø mm	52,5
Dimensions mm	
Length	526
Height	152
Width	81
Battery	18.0V 2.0Ah
Weight kg (with Battery)	3,91



STORAGE

Type	VAL-P59
Dimensions mm L x W x H	620 x 360 x 138
Weight kg	2,4
Supplied with the tool	✓



The tool is supplied as:

- Basic tool with battery and wrist strap
- Spare battery
- Battery charger
- USB cable
- Plastic carrying case suitable for storing the tool and accessories



B-TC500ND-SC

Tool Type	Plug Type	Supplied Battery Charger Type
B-TC500ND-SC	PLUG EU	ASC55-EU with EUROPEAN plug
B-TC500ND-SCE	PLUG UK	ASC30-36-UK with UK plug
B-TC500ND-SCA	PLUG USA CAN	ASC30-36-USA/CA (115V) with USA/CANADA plug
B-TC500ND-SCT	PLUG AUZ NZ	ASC30-36-AUS/NZ with AUSTRALIAN/NEW ZEALAND plug



B-TC500ND-SC is a new generation of hand-held cordless tools, characterised by a "Bilinear" mechanical design.

B-TC500ND-SC is specifically designed to cut Copper, Aluminium and telecommunication cable having a max overall diameter of 52,5 mm.

The blades are manufactured from high strength special Steel, heat treated to ensure a long service life. New Li-Ion 18.0V - 2.0Ah batteries offer a higher capacity, while greater cutting speed and cutting force result from a revitalised hydraulic system with double speed action.

The battery is equipped with led indicators that indicate the remaining battery life at any time by pressing the adjacent button.

The head can rotate through 180 degrees, to enable the operator to work in the most comfortable position, and can easily be opened to allow cutting of running cables. Quieter operation, illumination of the working area via LED lights and a minimum of vibration enhance the tool's practicality.

Two batteries and charger included.

Same charger of all our tools.

Operating temperature:

-15 to +50 °C

B-TC500

18.0 V CORDLESS HYDRAULIC CUTTING TOOL

industrial application

MAIN APPLICATIONS

specifically designed to cut Copper, Aluminium and Telecommunications cable having Ø max 50 mm

Tool Type	Plug Type	Supplied Battery Charger Type
B-TC500	PLUG EU	ASC55-EU with EUROPEAN plug
B-TC500E	PLUG UK	ASC30-36-UK with UK plug
B-TC500A	PLUG USA CAN	ASC30-36-USA/CA (115V) with USA/CANADA plug
B-TC500T	PLUG AUS NZ	ASC30-36-AUS/NZ with AUSTRALIAN/NEW ZEALAND plug



TECHNICAL FEATURES

Max cutting Ø mm	50
Dimensions mm	
Length	405
Height	398
Width	83
Battery	18.0V 5.2Ah
Weight kg (with Battery)	5,8

STORAGE

Type	VAL-P40
Dimensions mm L x W x H	520 x 432 x 126
Weight kg	2,6
Supplied with the tool	✓



The tool is supplied as:

- Basic tool with battery and shoulder strap
- Spare battery
- Battery charger
- USB cable
- Plastic carrying case suitable for storing the tool and accessories

Next generation of 18.0 V cordless hydraulic cutting tool specifically designed to cut Copper, Aluminium and telecommunication cable having a max overall diameter of 50 mm.

The blades are manufactured from high strength special Steel, heat treated to ensure a long service life.

New Li-Ion 18.0V - 5.2Ah batteries offer a higher capacity, while greater cutting speed and cutting force result from a revitalised hydraulic system with double speed action.

The battery is equipped with LED indicators to show the remaining battery life at any time by pressing the adjacent button.

The head can rotate through 90 degrees, to enable the operator to work in the most comfortable position, and can easily be opened to allow cutting of running cables.

Rubber grip inserts, low noise and minimal vibration aid operator comfort while additional convenience and safety are provided by LED lighting of the working area.

Operating temperature: -15 to +50 °C

18.0 V CORDLESS HYDRAULIC CUTTING TOOL

industrial application

B-TC650

MAIN APPLICATIONS

specifically designed to cut Copper, Aluminium and Telecommunications cable having Ø max 65 mm



TECHNICAL FEATURES

Max cutting Ø mm	65
Dimensions mm	
Length	429
Height	415
Width	83
Battery	18.0V 5.2Ah
Weight kg (with Battery)	6,4



STORAGE

Type	VAL-P40
Dimensions mm L x W x H	520 x 432 x 126
Weight kg	2,6
Supplied with the tool	✓



The tool is supplied as:

- Basic tool with battery and shoulder strap
- Spare battery
- Battery charger
- USB cable
- Plastic carrying case suitable for storing the tool and accessories

Tool Type	Plug Type	Supplied Battery Charger Type
B-TC650	PLUG EU	ASC55-EU with EUROPEAN plug
B-TC650E	PLUG UK	ASC30-36-UK with UK plug
B-TC650A	PLUG USA CAN	ASC30-36-USA/CA (115V) with USA/ CANADA plug
B-TC650T	PLUG AUS NZ	ASC30-36-AUS/NZ with AUSTRALIAN/ NEW ZEALAND plug

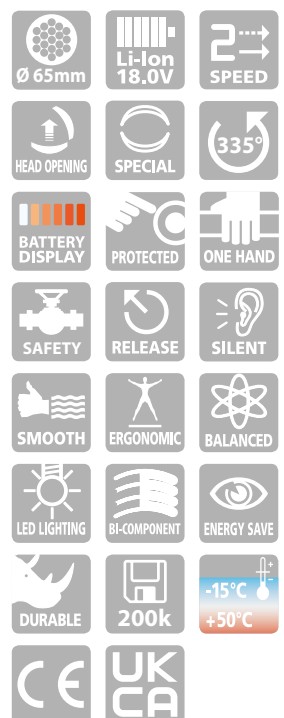

Next generation of 18.0 V cordless hydraulic cutting tool specifically designed to cut Copper, Aluminium and telecommunication cable having a max overall diameter of 65 mm.

The blades are manufactured from high strength special Steel, heat treated to ensure a long service life.

New Li-Ion 18.0V - 5.2Ah batteries offer a higher capacity, while greater cutting speed and cutting force result from a revitalised hydraulic system with double speed action. The battery is equipped with LED indicators to show the remaining battery life at any time by pressing the adjacent button.

The head can rotate through 335 degrees, to enable the operator to work in the most comfortable position, and can easily be opened to allow cutting of running cables.

Rubber grip inserts, low noise and minimal vibration aid operator comfort while additional convenience and safety are provided by LED lighting of the working area.

Operating temperature:

-15 to +50 °C

B-TC650-SC

18.0 V CORDLESS HYDRAULIC CUTTING TOOL

industrial application

MAIN APPLICATIONS

specifically designed to cut Copper, Aluminium and Telecommunications cable having Ø max 65 mm

Tool Type	Plug Type	Supplied Battery Charger Type
B-TC650-SC	PLUG EU	ASC55-EU with EUROPEAN plug
B-TC650-SCE	PLUG UK	ASC30-36-UK with UK plug
B-TC650-SCA	PLUG USA CAN	ASC30-36-USA/CA (115V) with USA/ CANADA plug
B-TC650-SCT	PLUG AUS NZ	ASC30-36-AUS/NZ with AUSTRALIAN/ NEW ZEALAND plug



Ø 65mm	Li-Ion 18.0V	SPEED
SPECIAL	180°	BATTERY DISPLAY
PROTECTED	ONE HAND	SAFETY
RELEASE	SILENT	SMOOTH
ERGONOMIC	BALANCED	LED LIGHTING
BI-COMPONENT	ENERGY SAVE	DURABLE
200k	-15°C to +50°C	CE

TECHNICAL FEATURES

Max cutting Ø mm	65
Dimensions mm	
Length	503
Height	464
Width	105
Battery	18.0V 5.2Ah
Weight kg (with Battery)	7,7

STORAGE

Type	VAL-B-TC950
Dimensions mm L x W x H	565 x 410 x 132
Weight kg	6,7
Supplied with the tool	✓

Next generation of 18.0 V cordless hydraulic cutting tool specifically designed to cut Copper, Aluminium and telecommunication cable having a max overall diameter of 65 mm.

The blades are manufactured from high strength special Steel, heat treated to ensure a long service life.

The open head and the "scissor" movement of the blades facilitate the cutting of running cables.

New Li-Ion 18.0V - 5.2Ah batteries offer a higher capacity, while greater cutting speed and cutting force result from a revitalised hydraulic system with double speed action.

The battery is equipped with LED indicators to show the remaining battery life at any time by pressing the adjacent button.

The head can rotate through 180 degrees, to enable the operator to work in the most comfortable position, and can easily be opened to allow cutting of running cables.

Rubber grip inserts, low noise and minimal vibration aid operator comfort while additional convenience and safety are provided by LED lighting of the working area.

Operating temperature: -15 to +50 °C



The tool is supplied as:

- Basic tool with battery and shoulder strap
- Spare battery
- Battery charger
- USB cable
- Metal carrying case suitable for storing the tool and accessories

18.0 V CORDLESS HYDRAULIC CUTTING TOOL

industrial application

B-TC950

MAIN APPLICATIONS

specifically designed to cut Copper, Aluminium and Telecommunications cable having Ø max 95 mm



TECHNICAL FEATURES

Max cutting Ø mm	95
Dimensions mm	
Length	518
Height	468
Width	83
Battery	18.0V 5.2Ah
Weight kg (with Battery)	7,8

STORAGE

Type	VAL-B-TC950
Dimensions mm L x W x H	565 x 410 x 132
Weight kg	6,7
Supplied with the tool	✓



The tool is supplied as:

- Basic tool with battery and shoulder strap
- Spare battery
- Battery charger
- USB cable
- Metal carrying case suitable for storing the tool and accessories

Tool Type	Plug Type	Supplied Battery Charger Type
B-TC950	PLUG EU	ASC55-EU with EUROPEAN plug
B-TC950E	PLUG UK	ASC30-36-UK with UK plug
B-TC950A	PLUG USA CAN	ASC30-36-USA/CA (115V) with USA/ CANADA plug
B-TC950T	PLUG A NZ AUS	ASC30-36-AUS/NZ with AUSTRALIAN/ NEW ZEALAND plug



Next generation of 18.0 V cordless hydraulic cutting tool specifically designed to cut Copper, Aluminium and telecommunication cable having a max overall diameter of 95 mm.

The blades are manufactured from high strength special Steel, heat treated to ensure a long service life.

New Li-Ion 18.0V - 5.2Ah batteries offer a higher capacity, while greater cutting speed and cutting force result from a revitalised hydraulic system with double speed action.

The battery is equipped with LED indicators to show the remaining battery life at any time by pressing the adjacent button.

The head can rotate through 335 degrees, to enable the operator to work in the most comfortable position, and can easily be opened to allow cutting of running cables.

Rubber grip inserts, low noise and minimal vibration aid operator comfort while additional convenience and safety are provided by LED lighting of the working area.

Operating temperature:

-15 to +50 °C

B-TC4500

18.0 V CORDLESS HYDRAULIC CUTTING TOOL

overhead line application

MAIN APPLICATIONS

specifically designed to cut Copper, aldrej, Aluminium, Aluminium-Steel cables and Steel ropes, Aluminium and Steel rods having Ø max 45 mm

Tool Type	Plug Type	Supplied Battery Charger Type
B-TC4500	PLUG EU	ASC55-EU with EUROPEAN plug
B-TC4500E	PLUG UK	ASC30-36-UK with UK plug
B-TC4500A	PLUG USA CAN	ASC30-36-USA/CA (115V) with USA/CANADA plug
B-TC4500T	PLUG AUS NZ	ASC30-36-AUS/NZ with AUSTRALIAN/NEW ZEALAND plug



TECHNICAL FEATURES

Max cutting Ø mm	45
Dimensions mm	
Length	486
Height	239
Width	103
Battery	18.0V 5.2Ah
Weight kg (with Battery)	6,44

STORAGE

Type	VAL-PS4
Dimensions mm L x W x H	690 x 446 x 179
Weight kg	5,5
Supplied with the tool	✓



The tool is supplied as:

- Basic tool with battery and shoulder strap
- Spare battery
- Battery charger
- USB cable
- Plastic carrying case suitable for storing the tool and accessories

Next generation of 18.0 V cordless hydraulic cutting tool specifically designed to cut Copper, aldrej, Aluminium, Aluminium-Steel cables and Steel ropes, Aluminium and Steel rods having a max overall diameter of 45 mm.

The blades are manufactured from high strength special Steel, heat treated to ensure a long service life.

New Li-Ion 18.0V - 5.2Ah batteries offer a higher capacity, while greater cutting speed and cutting force result from a revitalised hydraulic system with double speed action.

The battery is equipped with LED indicators to show the remaining battery life at any time by pressing the adjacent button.

The head can rotate through 180 degrees, to enable the operator to work in the most comfortable position, and can easily be opened to allow cutting of running cables. Rubber grip inserts, low noise and minimal vibration aid operator comfort while additional convenience and safety are provided by LED lighting of the working area. Operating temperature: -15 to +50 °C

CUTTING CAPACITY - a few examples

	MATERIAL	TENSILE STRENGTH (daN/mm ²)	MAX CUTTING DIAMETER (mm)
			B-TC4500
ROPE & CONDUCTORS	COPPER	≤ 41	45
	ALUMINIUM	≤ 20	45
	ALMELEC	≤ 34	45
	STEEL	≤ 180	INDICATIVE EXAMPLES: 7 x 3,0 : Ø est. = 9,0 mm 19 x 2,1 : Ø est. = 10,5 mm 19 x 2,3 : Ø est. = 11,5 mm
	MULTI STRANDS STEEL (STRANDS Qty ≥ 200)	≤ 180	18
RODS	ACSR	≤ 180	45 INDICATIVE EXAMPLES: 26 x 2,50 + 7 x 1,95 : Ø est. = 15,85 26 x 3,06 + 7 x 2,38 : Ø est. = 19,38 26 x 3,60 + 7 x 2,80 : Ø est. = 22,80 54 x 3,50 + 19 x 2,10 : Ø est. = 31,50 54 x 4,36 + 19 x 2,62 : Ø est. = 39,20
	STEEL	≤ 60	18
		≤ 42	20
	COPPER	≤ 30	30
	ALUMINIUM	≤ 16	45

18.0 V CORDLESS HYDRAULIC FRAME-TYPE HOLE PUNCHING TOOL

B-FC470

general features

MAIN APPLICATIONS

specifically designed to punching holes from 15,5 up to 47,2 mm diameter

TECHNICAL FEATURES

Max hole punch Ø mm	47,2
Max centre of hole to edge of trunking (mm)	53,5
Dimensions mm	
Length	379
Height	346
Width	83
Battery	18.0V 5.2Ah
Weight kg (with Battery)	6,2

STORAGE

Type	VAL-FC470
Dimensions mm L x P	559 x 459 x 131
Weight kg	6,7
Supplied with the tool	✓



The tool is supplied as:

- Basic tool with battery and shoulder strap
- Spare battery
- Battery charger
- USB cable
- Metal carrying case suitable for storing the tool and accessories



Table denotes the punch/die set reference, for each hole size. Suitable for punching holes in mild Steel, fibreglass or plastic material, up to 2 mm thick.

Hole Dimensions					Maximum thickness of mild Steel (mm)	Type
Nominal		Pg	ISO	Inch		
Ø (mm)	Ø (inch)					
15,5	.610	Pg9	-	-	2	RD15.5SS-FC
16,2	.638	-	ISO-16	-		RD16.2SS-FC
17,5	.689	-	-	-		RD17.5SS-FC
18,8	.740	Pg11	-	-		RD18.8SS-FC
19,1	.752	-	-	-		RD19.1SS
20,5	.807	Pg 13,5	ISO-20	-		RD20.5SS
22,6	.890	Pg16	-	-		RD22.6SS
23,8	.937	-	-	5/8"		RD23.8SS
25,4	1.000	-	ISO-25	-		RD25.4SS
27,0	1.063	-	-	3/4"		RD27SS
28,5	1.122	Pg21	-	-		RD28.5SS
30,5	1.201	-	-	7/8"		RD30.5SS
31,8	1.252	-	-	-		RD31.8SS
32,5	1.279	-	ISO-32	-		RD32.5SS
34,6	1.362	-	-	-		RD34.6SS
37,2	1.464	Pg29	-	-		RD37.2SS
38,1	1.500	-	-	-		RD38.1SS
40,5	1.594	-	ISO-40	-		RD40.5SS-FC
41,3	1.626	-	-	-		RD41.3SS-FC
42,5	1.673	-	-	1"1/4"		RD42.5SS-FC
43,2	1.701	-	-	-	RD43.2SS-FC	
44,5	1.752	-	-	-	RD44.5SS-FC	
47,2	1.858	Pg36	-	-	RD47.2SS-FC	

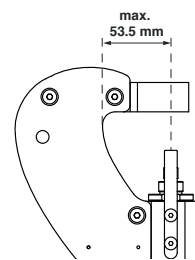

Tool Type	Plug Type	Supplied Battery Charger Type
B-FC470	PLUG EU	ASC55-EU with EUROPEAN plug
B-FC470E	PLUG UK	ASC30-36-UK with UK plug
B-FC470A	PLUG USA CAN	ASC30-36-USA/CA (115V) with USA/ CANADA plug



Next generation of 18.0 V cordless hydraulic cutting tool specifically designed to punching holes from 15,5 up to 47,2 mm diameter in the side wall of trunking without the need for pre drilling.

New Li-Ion 18.0V - 5.2Ah batteries offer a higher capacity, while greater punch speed and punching force result from a revitalised hydraulic system with double speed action. The battery is equipped with led indicators that indicate the remaining battery life at any time by pressing the adjacent button. The head can rotate through 180 degrees, to enable the operator to work in the most comfortable position, and can easily be opened to allow cutting of running cables.

Rubber grip inserts, low noise and minimal vibration aid operator comfort while additional convenience and safety are provided by LED lighting of the working area.

Operating temperature:

-15 to +50 °C

Also available in the hand operated mechanical version MT-FC48N (see page 148).

B-FL750ND

18.0 V CORDLESS HYDRAULIC PULLER-TYPE HOLE PUNCHING TOOL

general features

MAIN APPLICATIONS

specifically designed for hole punching stainless Steel, mild Steel, fibreglass and plastic sheet materials up to 3,5 mm thickness

Tool Type	Plug Type	Supplied Battery Charger Type
B-FL750ND	PLUG EU	ASC55-EU with EUROPEAN plug
B-FL750NDE	PLUG UK	ASC30-36-UK with UK plug
B-FL750NDA	PLUG USA CAN	ASC30-36-USA/CA (115V) with USA/CANADA plug
B-FL750NDT	PLUG AUS NZ	ASC30-36-AUS/NZ with AUSTRALIAN/NEW ZEALAND plug



TECHNICAL FEATURES

Max Punching Ø mm	140
Dimensions mm	
Length	474
Height	136
Width	81
Battery	18.0V/2.0Ah
Weight kg (with Battery)	4,1

STORAGE

Type	VAL-P57
Dimensions mm L x W x H	620 x 360 x 138
Weight kg	2,4
Supplied with the tool	✓



The tool is supplied as:

- Basic tool with battery and wrist strap
- Spare battery
- Battery charger
- USB cable
- Puller TD-11
- Puller TD-19
- Spiral bit Ø 11,5 mm
- Plastic carrying case suitable for storing the tool and accessories

B-FL750ND is a new generation of hand-held cordless tools, characterised by a "Bilinear" mechanical design. B-FL750ND is specifically designed for hole punching stainless Steel, mild Steel, fibreglass and plastic sheet materials up to 3,5 mm thickness. New Li-Ion 18.0V - 2.0Ah batteries offer a higher capacity, while greater punch speed and punching force result from a revitalised hydraulic system with double speed action. The battery is equipped with LED indicators that indicate the remaining battery life at any time by pressing the adjacent button. The balanced punching head pivots 180deg through a full 360deg rotation for ease of use in confined spaces. Rubber grip inserts, low noise and minimal vibration aid operator comfort while additional convenience and safety are provided by LED lighting of the working area. For the punch-die selection chart see page 223.

Operating temperature:
-15 to +50 °C

18.0 V CORDLESS HYDRAULIC PULLER-TYPE HOLE PUNCHING TOOL

general features

MAIN APPLICATIONS

specifically designed for hole punching stainless Steel, mild Steel, fibreglass and plastic sheet materials up to 3,5 mm thickness

TECHNICAL FEATURES

Max Punching Ø mm	140
Dimensions mm	
Length	363
Height	366
Width	83
Battery	18.0V 5.2Ah
Weight kg (with Battery)	5,1

STORAGE

Type	VAL-P56
Dimensions mm L x W x H	690 x 446 x 179
Weight kg	5,5
Supplied with the tool	✓



The tool is supplied as:

- Basic tool with battery and shoulder strap
- Spare battery
- Battery charger
- USB cable
- Puller TD-11
- Puller TD-19
- Spiral bit Ø 11,5 mm
- Plastic carrying case suitable for storing the tool and accessories



Universal joint allows punching head to pivot 180deg over a full 360deg rotation.

B-FL750

Tool Type	Plug Type	Supplied Battery Charger Type
B-FL750	PLUG EU	ASC55-EU with EUROPEAN plug
B-FL750E	PLUG UK	ASC30-36-UK with UK plug
B-FL750A	PLUG USA CAN	ASC30-36-USA/CA (115V) with USA/ CANADA plug
B-FL750T	PLUG NZ AUS	ASC30-36-AUS/NZ with AUSTRALIAN/ NEW ZEALAND plug



Next generation of 18.0 V cordless hydraulic tool specifically designed for hole punching stainless Steel, mild Steel, fibreglass and plastic sheet materials up to 3,5 mm thickness. New Li-Ion 18.0V - 5.2Ah batteries offer a higher capacity than 14.4 V 3 Ah, while greater punch speed and punching force result from a revitalised hydraulic system with double speed action.

The battery is equipped with LED indicators to show the remaining battery life at any time by pressing the adjacent button.

The balanced punching head pivots 180deg through a full 360deg rotation for ease of use in confined spaces.

Rubber grip inserts, low noise and minimal vibration aid operator comfort while additional convenience and safety are provided by LED lighting of the working area.

For the punch-die selection chart see page 223.

Operating temperature: -15 to +50 ° C

KIT-B-FL750-1

KIT FOR HOLE PUNCHING

general features



TECHNICAL FEATURES

Max Punching Ø mm	140
Dimensions mm	
Length	363
Height	366
Width	83
Battery	18.0V 5.2Ah
Weight kg (with Battery)	5,1

STORAGE

Type	VAL-P56
Dimensions mm L x W x H	690 x 446 x 179
Weight kg	5,5
Supplied with the tool	✓



KIT-B-FL750-1

Kit includes:

B-FL750 cordless hydraulic puller-type hole punching tool

VAL-P56 plastic carrying case with accessories

Puller TD-11

Puller TD-19

spiral bit Ø 11,5 mm

4 KIT for round punch:

KIT-RD18.8SS Pg11

KIT-RD20.5SS Pg13.5

KIT-RD22.6SS Pg16

KIT-RD28.5SS Pg21



The tool is supplied as:

- Basic tool with battery and shoulder strap
- Spare battery
- Battery charger
- USB cable
- Puller TD-11, Puller TD-19
- Spiral bit Ø 11,5 mm
- Plastic carrying case suitable for storing the tool and accessories

MPC1

PRESSURE TEST DEVICE

for hydraulic pumps and tools



MPC1 device

The MPC1 device, complete with test adapter set, is used to measure the maximum oil pressure on all Cembre tools.

MPC2



MPC2 device

The MPC2 device, complete with test die set, to measure the maximum force developed by Cembre tools:

HT131-C, HT131LN-C, HT120, HT120-KV, RHC131, RHC131-KV, RHC131LN, B131-C, B131-C-KV, B131LN-C, B131LN-C-KV, B135-C, B135-C-KV, B135LN-C, B135LN-C-KV.

MPC4



MPC4 device

The MPC4 device, complete with test die set, to measure the maximum force developed by Cembre tools:

ECW-H3D, RHU240-3D-850, RHU300-3D

MPC7



MPC7 device

The MPC7 device, complete with test die set, to measure the maximum force developed by Cembre tools:

HT45, HT51, HT51-KV, HT51L, HT51L-KV, RH50, HT61, RH61, B15D (use adaptor available separately), B35-45MD, B35-50MD, B46, B51, B51-KV, B51L, B51L-KV, B54D, B55, B55-KV, B62.

HYDRAULIC PUMPS AND UNITS



PO7000

HYDRAULIC PUMP

foot operated



Foot operated double speed pump, developing a maximum pressure of 700 bar. The pump is supplied with 3 m long high pressure flexible hose complete with female self-lock quick coupler. Pressure can be withdrawn at any time during operation by depressing the release lever. A solid shaped stand gives the pump stability during operation.

TECHNICAL FEATURES

Operating pressure bar	700
Dimensions mm	
Length	680
width	200
Height	163
Weight kg	9,8

STORAGE

Type	VAL-P21
Dimensions mm L x W x H	820 x 430 x 290
Weight kg	6,74
Supplied with the pump	✓



CPP-0

HYDRAULIC PUMP

foot operated



The CPP-0 air hydraulic power unit intensifies an air supply of 5÷8 bar (73-115 psi) to a power crimping or cutting force of up to 700 bar (10.000 psi) depending upon the input pressure. The control pedal allows for advancing and pressure release at any stage of the operation. The unit is provided with a 2 m high pressure flexible hose, including a 3/8" NPT female self-lock quick coupler.

TECHNICAL FEATURES

Operating pressure bar	700
Dimensions mm	
Length	320
width	150
Height	200
Weight kg	6,8

HYDRAULIC PUMP

powered by single-phase electric motor

CPE-1 CPE-1-110

TECHNICAL FEATURES

Operating pressure bar	700
Dimensions mm	
Length	372
width	223
Height	482
Weight kg	21

The pump is supplied with:

- high pressure flexible hose with male and female automatic quick coupler
- remote hand controller
- external supply connection cable



Electrically driven hydraulic pump, powered by a 230V / 50-60Hz single-phase electric motor. The remote hand controller allows advancement and pressure release on completion of the crimping operation.

The mechanically actuated emergency button located on the pump body allows the pressure release at any time in case of power shortage.

Also available CPE-1-110 version for 110-115V / 50-60Hz. Both models are IP 55 rated.

Available as optional accessories:

- Remote foot controller RCP-B70.
- Transportation trolley CS-CPE-1
- Control handle integrated with 3 m length flex hoses ERCH-WH

ERCH-WH



RCP-B70

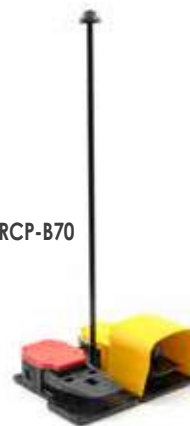

CS-CPE-1



B1300PL

PORTABLE ELECTRO-HYDRAULIC PUMP

battery operated

Tool Type	Plug Type	Supplied Battery Charger Type
B1300PL	PLUG EU	ASC55-EU with EUROPEAN plug
B1300PLE	PLUG UK	ASC30-36-UK with UK plug
B1300PLA	PLUG USA	ASC30-36-USA/CA (115V) with USA/ CANADA plug
B1300PLT	PLUG AUS	ASC30-36-AUS/NZ with AUSTRALIAN/ NEW ZEALAND plug



TECHNICAL FEATURES

Operating pressure bar	700
Dimensions mm	
Length	354
width	103
Height	240
Battery	18.0V 5.2Ah
Weight kg (with Battery)	4,0

STORAGE

Type	VAL-P51
Dimensions mm L x W x H	690 x 446 x 179
Weight kg	5,5
Supplied with the pump	✓



The B1300PL pump is supplied with:

- 0,9 m flexible hose complete with male + female 3/8" NPT self-lock quick couplers.
- 18,0 V - 4,0 Ah Li-Ion high power battery
- Battery charger
- Shoulder strap
- Plastic carrying case suitable for storing the tool and accessories, type VALP51

New portable electro-hydraulic pump B1300PL is battery operated for independent use. Having the inherent strengths of the Cembre 18V tool range the B1300PL is a compact, lightweight pump suitable for a wide range of applications. New Li-Ion 18 V 5.2 Ah batteries offer a high capacity, while improved operating speed results from a revitalised hydraulic system with double speed action. A security valve assures operator safety. Designed with improved handling characteristics, B1300PL is easily manageable during the operating process and, by the use of bi-component plastics, has a shell with high resistance to wear and damage.

Rubber grip inserts, low noise and minimal vibration aid operator comfort while additional convenience and safety are provided by LED lighting of the working area. Pressure can be released at any time using the appropriate button.

Pressure can be released at any time using the appropriate button.

APPLICATION RANGE

Crimping	Cutting	Punching
up to 130 kN	up to TC 050	RH-FL75 RH-FC48N

PORTABLE ELECTRO-HYDRAULIC PUMP

battery operated

TECHNICAL FEATURES

Operating pressure bar	700
Dimensions mm	
Length	364
width	186
Height	236
Battery	18.0V 5.2Ah
Weight kg (with Battery)	5,6

STORAGE

Type	CVB-031
Dimensions mm L x W x H	620 x 300 x 320
Weight kg	2,4
Supplied with the pump	✓



The B68M-P18 pump is supplied with:

- Remote control provides LED working lights and an OLED display
- 2 m flexible hose complete with rotatable Q14-F quick coupler on the pump and female 3/8" NPT self-lock quick couplers
- 18.0 V - 4.0 Ah Li-Ion high power battery (2 pcs.)
- Canvas bag suitable for storing the tool and accessories
- Battery charger
- Shoulder strap



APPLICATION RANGE

Crimping	Cutting	Punching
up to 230 kN	up to TC 120	RH-FL75 RH-FC48N

Example of operating information on OLED display:



Operating mode



Battery level



Release mode



No. of cycles

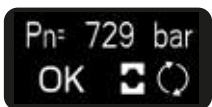

Pressure mode



Motor temperature



B68M-P18

Tool Type	Plug Type	Supplied Battery Charger Type
B68M-P18	PLUG EU	ASC55-EU with EUROPEAN plug
B68M-P18E	PLUG UK	ASC30-36-UK with UK plug
B68M-P18A	PLUG USA	ASC30-36-USA/CA (115V) with USA/CANADA plug
B68M-P18T	PLUG NZ AUS	ASC30-36-AUS/NZ with AUSTRALIAN/NEW ZEALAND plug



New portable electro-hydraulic pump B68M-P18 is battery operated for independent use.

Having the inherent strengths of the Cembre 18V tool range, the B68M-P18 is a lightweight high capacity pump equipped with an innovative remote control suitable for a wide range of applications. New Li-Ion 18V 5.2 Ah batteries offer a high capacity, while improved operating speed results from a revitalised hydraulic system with double speed action.

A maximum pressure sensor assures greater precision and repeatability of the pressure cycle, while a security valve doubles the provision for operator safety.

The unit has a manual pressure release button in case of emergency. Easy access to the oil reservoir is by means of an oil top-up inlet. The innovative remote control provides LED working lights and an OLED display of essential real time

tool operating information including:

- Operating mode selection
- Release mode selection: Smart release, manual release
- Minimum set pressure and momentary pressure reached expressed in bar allows verification of correct operation
- Battery charge level
- No. of cycles performed
- No. of cycles before scheduled recommended maintenance
- Motor temperature

The pump features a rubber pocket to store and protect the remote control.

Low noise levels aid operator comfort while additional convenience and safety are provided by LED lighting on the remote control.

Selecting the SMART release mode on the OLED display allows the operating pressure to be maintained until the operating button is released, thus allowing the operator to make a visual check of, say, the crimped connection.

PORTABLE ELECTRO-HYDRAULIC PUMPS B70M-P36 RANGE

battery operated



Easily accessible oil top-up inlet



Toggle button for direct operation via the pump



Remote electrical hand or foot controller connection

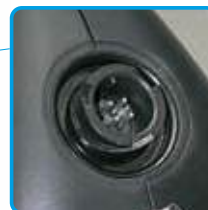

High pressure hose connects to automatic self-lock quick coupling with protective cap



Automatic battery connection system



1



OLED multifunctional display



Smart Logo



Manual pressure release button



Pump on (constant) In action (pulse) End of cycle Cycle error Anomaly Maintenance

New generation pumps B70M-P36 are powered by an all new 36.0V 6.2Ah Li-Ion high capacity rechargeable battery providing independence and portability. Fitted with a maximum pressure sensor (EPS) for enhanced precision and repeatability of the maximum pressure cycle, and a pressure relief valve providing additional safety for the operator. These units feature the Smart Release system which automatically retracts the ram at the end of the operating cycle. The manual toggle button can be used to operate and release the pressure directly from the pump. (inhibited when the remote control is used for safety reasons). Oil top-up inlet for easy access to the oil reservoir. Extremely compact and suitable for a wide range range of applications. The Cembre logo acts as an indicator by changing colour to provide the operator with instantaneous visual confirmation of the pumps status, such as: pump ready, pump in use, end of cycle, cycle error, anomaly, maintenance required. The new design and ergonomic weight distribution allows the pump to be easily handled during use.

The rigid structure of the plastic body ensures adequate mechanical protection and guarantees IP44M protection due to the presence of gaskets at the interface of the body shells. The ergonomically designed handle helps to increase operator comfort when moving the pump. Quieter operation, and the absence of vibrations ensure maximum operator comfort. Equipped with a 3m long high pressure hose complete with a male quick coupling on the pump and a self-locking female quick coupling. The pressure can be released at any time using the pressure release button.

The unit features an OLED display to provide essential real time tool operating information including:

- Operating mode selection (cutting, crimping or piercing)
- Release mode selection (Smart release, manual release)
- Minimum set pressure and snapshot pressure reached in bar/psi to allow verification of correct operation
- Battery charge level
- No. of cycles performed
- No. of cycles before scheduled recommended maintenance
- Motor temperature

- Operational command (hand controller or manual on the pump)



Can be used in vertical or horizontal position

PORTABLE ELECTRO-HYDRAULIC PUMP

battery operated

B70M-P36

- 1 Portable electro-hydraulic pump, 36V battery for independent use, developing 700 bar pressure
- 2 CB3662L Battery 36 V - 6,2 Ah Li-Ion
- 3 ASC-ULTRA-EU External battery charger
- 4 USB cable
- 5 Shoulder strap
- 6 CVB-037 Canvas rucksack for carrying accessories
- 7 3 m flexible hose complete with male + female 3/8" NPT self-lock quick couplers
- 8 ERCH Remote control

APPLICATION RANGE

Crimping	Cutting	Punching
up to 520 kN	up to TC120	RH-FL75 RH-FC48N



B70M-P36

Tool Type	Plug Type	Supplied Battery Charger Type
B70M-P36	PLUG EU	ASC55-EU with EUROPEAN plug
B70M-P36E	PLUG UK	ASC30-36-UK with UK plug
B70M-P36A	PLUG USA/CA	ASC30-36-USA/CA (115V) with USA/CANADA plug
B70M-P36T	PLUG AU/NZ	ASC30-36-AUS/NZ with AUSTRALIAN/NEW ZEALAND plug

TECHNICAL FEATURES

Operating pressure bar	700
Dimensions mm	
Length	405
width	161
Height	327
Battery	36V 6.2Ah
Weight kg (with Battery)	10.0*

*without accessories

PORTABLE ELECTRO-HYDRAULIC PUMP

battery operated

B70M-P36-CH

- 1 Portable electro-hydraulic pump, 36V battery for independent use, developing 700 bar pressure
- 2 CB3662L Battery 36 V - 6,2 Ah Li-Ion
- 3 ASC-ULTRA-EU External battery charger
- 4 USB cable
- 5 Shoulder strap
- 6 CVB-037 Canvas rucksack for carrying accessories
- 9 ERCH-WH Remote hand controller integrated with 3 m length flexible hose complete with male + female 3/8" NPT self-lock quick couplers

APPLICATION RANGE

Crimping	Cutting	Punching
up to 520 kN	up to TC120	RH-FL75 RH-FC48N



B70M-P36-CH

Tool Type	Plug Type	Supplied Battery Charger Type
B70M-P36-CH	PLUG EU	ASC55-EU with EUROPEAN plug
B70M-P36E-CH	PLUG UK	ASC30-36-UK with UK plug
B70M-P36A-CH	PLUG USA/CA	ASC30-36-USA/CA (115V) with USA/CANADA plug

TECHNICAL FEATURES

Operating pressure bar	700
Dimensions mm	
Length	405
width	161
Height	327
Battery	36V 6.2Ah
Weight kg (with Battery)	10.0*

*without accessories

Variously supplied with different versions:



ACCESSORIES FOR B70M-P36

purchase separately

TRS-B70
Canvas rucksack
(for carrying the pump)



ERCH-WH
Remote hand controller integrated
with 3 m length flexible hose



SH-B70
Hook for hanging the pump
from a ladder

VAL-P18
Durable transport case for pump
and accessories.



RCP-B70
Portable remote foot control

HYDRAULIC UNIT

CP1131

pump PO7000 + head RHC131

MAIN APPLICATIONS - max section sqmm

Section sqmm	0.25-1.5	1.5-2.5	4-6	10	16	25	35	50	70	95	120	150	185	200	240	300	400	500	630	800	1000	
L.V. lugs and splices																						
Insulated terminals																						
"C" sleeve Connectors																						
H.V. lugs																						
H.V. Splices*																						

*limited to the cable insulation diameter

These tools are supplied without dies. For die selection, please refer to chart on pages 260 to 274

TECHNICAL FEATURES

Crimping force kN	130
Dimensions mm	
Dimensions pump L x W x H	680 x 200 x 163
Dimensions head L x H	232 x 124
Weight unit kg	13,6

STORAGE

Type	VAL-P21*
Dimensions mm L x W x H	820 x 430 x 290
Weight kg	6,74
Supplied with the unit	✓

*Supplied with the unit, suitable for storage of 24 semi-circular slotted dies



HYDRAULIC UNIT

CPU1131-C

pump PO7000 + head RHU131-C

MAIN APPLICATIONS - max section sqmm

Section sqmm	0.25-1.5	1.5-2.5	4-6	10	16	25	35	50	70	95	120	150	185	200	240	300	400	500	630	800	1000	
L.V. lugs and splices																						
Insulated terminals																						
"C" sleeve Connectors																						
Alu lugs and splices																						
H.V. lugs and splices																						

These tools are supplied without dies. For die selection, please refer to chart on pages 260 to 274

TECHNICAL FEATURES

Crimping force kN	130
Dimensions mm	
Dimensions pump L x W x H	680 x 200 x 163
Dimensions head L x H	245 x 89
Weight unit kg	13,5

STORAGE

Type	VAL-P21*
Dimensions mm L x W x H	820 x 430 x 290
Weight kg	6,74
Supplied with the unit	✓

*Supplied with the unit, suitable for storage of 24 semi-circular slotted dies and accessories for crimping Aluminium connectors

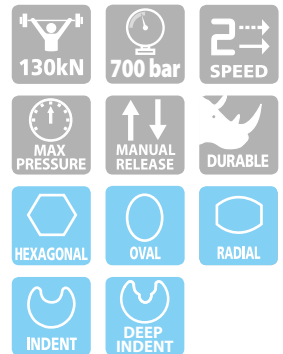

CPU1230-3D

HYDRAULIC UNIT

pump PO7000 + head ECW-H3D



MAIN APPLICATIONS - max section sqmm

Section sqmm	0.25-1.5	1.5-2.5	4-6	10	16	25	35	50	70	95	120	150	185	200	240	300	400	500	630	800	1000	
L.V. lugs and splices																						
Insulated terminals																						
"C" sleeve Connectors																						
H.V. lugs and splices																						

These tools are supplied without dies. For die selection, please refer to chart on pages 260 to 274



TECHNICAL FEATURES

Crimping force kN	230
Dimensions mm	
Dimensions pump L x W x H	680 x 200 x 163
Dimensions head L x H	290 x 120
Weight unit kg	15,3

STORAGE

Type	VAL-P21*
Dimensions mm L x W x H	820 x 430 x 290
Weight kg	6,74
Supplied with the unit	✓

*Supplied with the unit, suitable for storage of 24 semi-circular slotted dies and adaptors and dies specific for head ECW-H3D



HYDRAULIC CUTTING UNIT

CP1096

pump PO7000 + head TC096

TECHNICAL FEATURES

Max cutting Ø mm	95
Dimensions mm	
Dimensions pump L x W x H	680 x 200 x 163
Dimensions head L x H	397 x 249
Weight unit kg	17,7

STORAGE

Type	VAL-CP096
Dimensions mm L x W x H	785 x 430 x 175
Weight kg	10,0
Supplied with the unit	✓



HYDRAULIC CUTTING UNIT

CP1120

pump PO7000 + head TC120

TECHNICAL FEATURES

Max cutting Ø mm	120
Dimensions mm	
Dimensions pump L x W x H	680 x 200 x 163
Dimensions head L x H	536 x 175
Weight unit kg	19,3

STORAGE

Type	VAL-22-TC120
Dimensions mm L x W x H	766 x 305 x 191
Weight kg	8,3
Supplied with the unit	✓



CP-W-KV

HYDRAULIC CUTTING UNIT

according to DIN EN 50340 - VDE 0682 part 661



GS approval
n. ET 13045

Hydraulic units provide protection against short circuit when accidentally cutting live L.V. / M.V. cables with nominal voltage up to 60 kV.

CP 1086-W-1000-KV

TECHNICAL FEATURES

Max cutting Ø mm	85
Dimensions mm	
Dimensions pump L x W x H	680 x 200 x 163
Dimensions head L x H	405 x 143
Weight unit kg	16,6

CP 1096-W-1000-KV

TECHNICAL FEATURES

Max cutting Ø mm	95
Dimensions mm	
Dimensions pump L x W x H	680 x 200 x 163
Dimensions head L x H	407 x 245
Weight unit kg	19,0

CP 1120-W-1000-KV

TECHNICAL FEATURES

Max cutting Ø mm	120
Dimensions mm	
Dimensions pump L x W x H	680 x 200 x 163
Dimensions head L x H	556 x 185
Weight unit kg	20,2

Available as optional accessories:

- EK100 earth cable for the pump (1 m length)
- EK500P earth cable for the head (5 m length) with earth rod and canvas bag



STORAGE

Type	VAL-CP096-W
Dimensions mm L x W x H	785 x 430 x 175
Weight kg	10,0
Supplied with the unit	✓



PORTABLE BATTERY HYDRAULIC CUTTING UNITS

radio controlled - for remote cutting operations

B68RC3

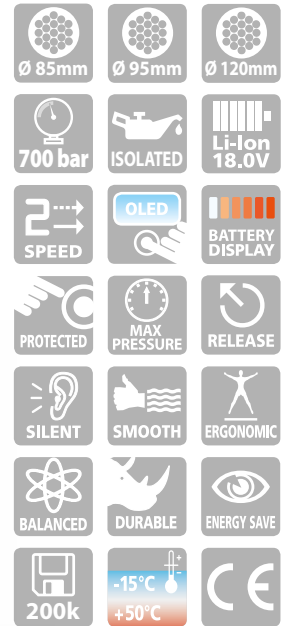

B68RC3-85

TECHNICAL FEATURES

Max cutting Ø mm	85
Dimensions mm	
Dimensions pump L x W x H	417 x 236 x 212
Dimensions head L x H	409 x 174 x 140
Weight unit kg	13,68

B68RC3-96

TECHNICAL FEATURES

Max cutting Ø mm	95
Dimensions mm	
Dimensions pump L x W x H	417 x 236 x 212
Dimensions head L x H	498 x 249 x 147
Weight unit kg	17,24

B68RC3-120

TECHNICAL FEATURES

Max cutting Ø mm	120
Dimensions mm	
Dimensions pump L x W x H	417 x 236 x 212
Dimensions head L x H	536 x 223 x 140
Weight unit kg	18,44



The heart of each unit is the new portable pump B68M-P18-KV-RC3, battery operated for independent use. Having the inherent strengths of the Cembre 18V tool range, the B68M-P18-KV-RC3 is a lightweight high capacity pump equipped with an innovative radio remote control designed specifically for man-hole environments to allow operators to control and operate the pump out of the man-hole at a safe distance.

New Li-Ion 18V 7Ah batteries provide high capacity while improved operating speed results from a revitalized hydraulic system with double speed action.

A maximum pressure sensor assures greater precision and repeatability

of the pressure cycle, while a security valve doubles the provision for operator safety.

The unit is fitted with a patented unique system for stopping the pump when the cutting head sensor signals that its blades have travelled fully.

At this point the LED indicator and buzzer notify the operator of the successful completion of the cutting operation. For this reason, each pump is paired to its specific cutting head only and it must be considered as a complete unit.

The innovative remote control function is able to work in man-hole environment where radio communication is normally more complicated.

The unit features an OLED display to provide essential real time tool operating information including:

- Operating mode selection (cutting or crimping)
- Release mode selection (Smart release, manual release)
- Minimum set pressure and momentary pressure reached in bar/psi to allow verification of correct operation
- Battery charge level
- No. of cycles performed
- No. of cycles before scheduled recommended maintenance
- Motor temperature
- Operating command (radio or manual).

Available as optional accessories:

- CVB-031 Canvas bag
- EK100 Earth cable for the pump (1 m length)
- EK500P Earth cable for the head (5 m length) with earth rod and canvas bag



CVB-031



EK500P



EK100

Supplied with:

- Radio remote control (2405 ÷ 2480 MHz)
- CB1880L, Li-Ion 18.0 V 7.0 A h Battery (2 pcs)
- ASC55-EU, Battery charger
- 10 m length high pressure flexible hose
- USB cable
- Shoulder strap
- VAL-B68RC3 Metal Carrying Case

STORAGE

Type	VAL-B68RC3
Dimensions mm L x W x H	665 x 422 x 260
Weight kg	17,4
Supplied with the unit	✓



CB BH ASC CFC BPS

Accessories for cordless tools



CB1820L



CB1852L
CB1880L



CB3662L



CB1430L



CB1430H



CB9630H



BH2433

battery

	Type	Description	Technology	Ah	V
STANDARD	CB1820L	CB1820L 18V-2.0Ah battery	Li-Ion	2.0	18
	CB1852L	CB1852L 18V-5.2Ah battery	Li-Ion	5.2	18
	CB1880L	CB1880L 18V-8.0Ah battery	Li-Ion	8.0	18
	CB3662L	CB3662L 36V-6.2Ah battery	Li-Ion	6.2	36
ON REQUEST	CB1430L	CB1430L 14.4V-3.0Ah battery	Li-Ion	3.0	14.4
	CB9630H	CB9630H 9.6V-3.0Ah battery	Ni-MH	3.0	9.6
	CB1430H	CB1430H 14.4V-3.0Ah battery	Ni-MH	3.0	14.4
	BH2433	BH2433 24V-3.3Ah battery	Ni-MH	3.3	24



ASC55-EU



ASC-ULTRA-EU



CFC230N

battery charger

Type	Description	V
ASC55-EU	ASC55-EU battery charger	18
ASC-ULTRA-EU	ASC-ULTRA-EU battery charger	18 - 36
CFC230N	CFC230N 230V AC battery charger	14.4



BPS230-9.6



BPS230.14

power supplies

Type	Description	V
BPS230-9.6	BPS230.96 (230V -9.6V) power supplies	9.6
BPS230.14	BPS230.14 (230V -14.4V) power supplies	14.4



6000354



6006309

others

Type	Description
6000354	Shoulder strap for battery tools
6006309	USB2.0/MINI USB B M-M 1.8 m cable black

Accessories for storage of dies

VAL



VALMAT

VAL-130

VAL-MAT230-630

VALMAT-520

VAL-75

CVB-013

carrying case - bags

Type	Description
VALMAT	Metal carrying case suitable for the storage of semicircular dies
VALMAT-230-630	Metal carrying case suitable for the storage of accessories for crimping Aluminium connectors
VALMAT-520	Metal carrying case suitable for storage of 10 sets of hexagonal dies for the head RHU520
VAL-130	Metal carrying case suitable for the storage of accessories for crimping Aluminium connectors
VAL-75	Plastic case suitable for containing tool dies for HT81-U; RHU81; RH50; RHM50
CVB-013	Canvas bag

Transport accessories

CVB



CVB-030

CVB-031

CVB-037

VAL-P18

canvas bag - trolley

Type	Description
CVB-030	Canvas bag for carrying tools and accessories
CVB-031	Canvas bag for the transport of pump and accessories
CVB-037	Canvas rucksack for transporting pump and accessories
VAL-P18	Wheeled transport case for pump and accessories

TF

Accessories for non-insulated hydraulic pumps



non-insulated flexible hoses (extensions)

Type	Length m	Quick Coupler	Description
TF300-Q38FM	3	F/M	High pressure flexible hose fitted with automatic quick couplers
TF600-Q38FM	6	F/M	High pressure flexible hose fitted with automatic quick couplers
TF200-Q14FM	2	F/M	High pressure flexible hose fitted with automatic quick couplers
TF500-Q38FM	5	F/M	High pressure flexible hose fitted with automatic quick couplers
TF1000-Q38FM	10	F/M	High pressure flexible hose fitted with automatic quick couplers
ERCH-WH	3	F/M	Remote hand controller integrated with high pressure flexible hose complete with automatic quick couplers for B70M-P36; CPE-1

Q-M, Q-F

Quick couplers for non-insulated flexible hoses



Q14-MS

Q14-MS
Male automatic coupler for hydraulic heads (1/4" NPT).



Q38-F

Q38-F
Female automatic coupler with safety ring for hydraulic pumps and flexible hoses (3/8" NPT).



Q38-MS

Q38-MS
Male automatic coupler for flexible hoses (3/8" NPT).

TF-I

Accessories for insulated hydraulic pumps



TF...-I.

insulated flexible hoses (extensions)

Type	Length m	Insulated Quick Coupler	Description
TF1000-I38FM-KVE	10	F/M	10 m long high pressure flexible hose equipped with insulated oil with high dielectric power and with "insulated" type quick couplers with automatic locking, complete with case
TF500-I38FM-KV	5	F/filettoM	5 m long high pressure flexible hose equipped with insulated oil with high dielectric power and with "insulated" type quick couplers with automatic locking

I-F, I-M

Quick couplers for insulated flexible hoses



I38-F

I38-F
Female automatic coupler with safety ring for insulated hydraulic pumps and flexible hoses (3/8" NPT).



I38-MS

I38-MS
Male automatic coupler for insulated flexible hoses (3/8" NPT).

MARKETLINE PRODUCTS

In this section of the catalogue you can find selected products at competitive price which complement our traditional range



symbol description

Marketline products

PA 6.6

Nylon PA6.6 material



UL marking

PA12

Elastomerized Polymer on Polyamide base material



Halogen free

POLYESTER

Coated with Polyester for insulation purpose



Operating temperature range

PVC

PVC material



V2 UL94 self-extinguishing class

PET

PET body



V0 UL94 self-extinguishing class

STAINLESS STEEL

Stainless steel material



HB UL94 self-extinguishing class

SHIRINKABLE

Heat shrinkable



In accordance with EN

UV RESISTANT

UV resistant



In accordance with DIN VDE

symbol description

Marketline products



Can be operated with one hand



Durable moulded body offering high resistance to wear and damage in all operating conditions



Ergonomically designed with a sculptured body for operator comfort



Lightweight and balanced tool for greater control



Radial crimp



Trapezium crimp



Indent crimp





CABLE TIES

G series, PA6.6 Polyamide

PA 6.6



HF
HALOGEN
FREE

Material: PA6.6 Polyamide
 Self-extinguishing V2 (UL 94)
 Humidity absorption:
 2,5% (at 50% relative humidity)
 Operating temperature:
 From -40°C to +85°C (continuous)
 From -40°C to +120°C (short periods)
 Resistant to:
 oils, greases, oil products, chlorinated solvents.
 Colour: Natural or Black (Ral 2005)

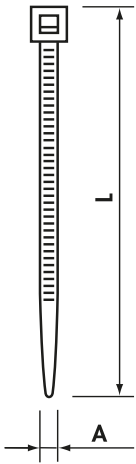

Black ties have higher UV resistance due to increased carbon black loading

Natural ties offer rapid installation due to the low friction coefficient of the material

Cable Ties in PA6.6

Type	L (mm)	A (mm)	Max. Bundle Ø (mm)	Min. Loop Tensile Strength (kg)	Quantity		
G80X2.4	80	2,4	15	8	100		
G80X2.4N					1000		
G80X2.4/M			16		100		
G80X2.4N/M					1000		
G90X2.4	90	2,4	15		8	100	
G90X2.4N						1000	
G100X2.5			16			22	100
G100X2.5N							1000
G100X2.5/M	30	33	100				
G100X2.5N/M			1000				
G120X2.5	120	2,5	15	8		100	
G120X2.5N						1000	
G140X2.5			16		22	100	
G140X2.5N						1000	
G140X2.5/M	30	33	1000				
G140X2.5N/M			1000				
G160X2.5	160	2,5	15		8	100	
G160X2.5N						1000	
G160X2.5/M			16	22		1000	
G160X2.5N/M						1000	
G200X2.5	200	2,5	15	8		100	
G200X2.5N						1000	
G200X2.5/M			16			22	1000
G200X2.5N/M							1000
G250X2.8	250	2,8	14		14	100	
G250X2.8N						1000	
G300X2.8			15			22	100
G300X2.8N							1000
G120X3.6	120	3,6	14	14		100	
G120X3.6N						1000	
G140X3.6			16			22	1000
G140X3.6/M							1000
G140X3.6N/M	16	22	100				
G150X3.6			1000				
G150X3.6N	150	3,6	14		14	100	
G180X3.6						1000	
G180X3.6N			16	22		100	
G200X3.6						1000	
G200X3.6N	200	3,6	14	14		1000	
G200X3.6/M						1000	
G200X3.6N/M			16			22	1000
G250X3.6							1000
G250X3.6N	250	3,6	14		14	100	
G300X3.6						1000	
G300X3.6N			16			22	100
G300X3.6/M							1000
G300X3.6N/M	300	3,6	14	14		1000	
G370X3.6						1000	
G370X3.6N			16			22	102
G120X4.8							102
G120X4.8N	120	4,8	14		14	100	
G160X4.8						1000	
G160X4.8N			16			22	38
G190X4.8							100
G190X4.8N	190	4,8	14	14		1000	
G190X4.8/M						1000	
G190X4.8N/M			16			22	46
G200X4.8							100
G200X4.8N	200	4,8	14		14	1000	
G200X4.8/M						1000	
G200X4.8N/M			16			22	50
G250X4.8/M							1000
G250X4.8N/M	250	4,8	14	14		1000	
G250X4.8						1000	
G250X4.8N			16			22	60
G280X4.8							100
G280X4.8N	280	4,8	14		14	100	
G300X4.8						1000	
G300X4.8N			16			22	76
G370X4.8							100
G370X4.8N	370	4,8	14	14		102	
G390X4.8						102	
G390X4.8N			16			22	105
G430X4.8							105
G430X4.8N	430	4,8	14		14	110	
						110	

Minimum order: 1,000 pcs

Minimum order: 100 pcs

Note: In Type, N = Black

Recommended tools are shown on page 258

The dimensions shown in the table must be considered as nominal. Cembre reserves the right to make changes without prior notice

CABLE TIES



G series, PA6.6 Polyamide

Cable Ties in PA6.6

Type	L (mm)	A (mm)	Max. Bundle Ø (mm)	Min. Loop Tensile Strength (kg)	Quantity			
G450X4.8	450	4,8	116	22	100			
G450X4.8N								
G530X4.8	530	4,8	140	22				
G530X4.8N								
G150X7.6	150	7,6	33	55				
G150X7.6N								
G200X7.6	200		50			50		
G200X7.6N								
G250X7.6	250		65			65		
G250X7.6N								
G300X7.6	300		76			76		
G300X7.6N								
G370X7.6	370		102			102		
G370X7.6N								
G430X7.6	430		125			125		
G430X7.6N								
G530X7.6	530		140			140		
G530X7.6N								
G430X9.0	430		9,0			110	80	
G430X9.0N								
G530X9.0	530					140		140
G530X9.0N								
G710X9.0	710					190		190
G710X9.0N								
G780X9.0	780				228	228		
G780X9.0N								
G830X9.0	830				239	239		
G830X9.0N								
G920X9.0	920	263		263				
G920X9.0N								
G1020X9.0	1020	295		295				
G1020X9.0N								
G1220X9.0	1220	365		365				
G1220X9.0N								
G230X12.6	230	12,6		50	115			
G230X12.6N								
G380X12.6	380			106		106		
G480X12.6								480
G480X12.6N								
G580X12.6	580			152		152		
G580X12.6N								
G730X12.6	730			204		204		
G730X12.6N								
G880X12.6	880		248	248				
G880X12.6N								
G1030X12.6	1030		295	295				
G1030X12.6N								

Note: In Type, N = Black

Recommended tools are shown on page 258

The dimensions shown in the table must be considered as nominal. Cembre reserves the right to make changes without prior notice

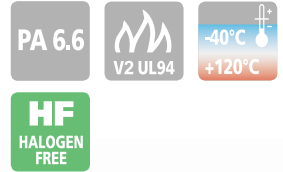

Angled tongue to facilitate easy introduction into the buckle



Rounded corners for increased safety



Minimum order: 100 pcs

GR

CABLE TIES

GR series, PA6.6 Polyamide



HF
HALOGEN FREE

Same features as G series.
Easy installation without tools.
Released by pressure on the tongue.
Suitable for temporary locking.

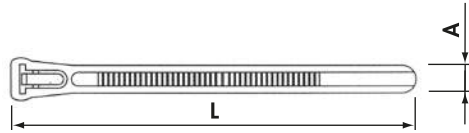

Releasable cable ties in PA6.6

Type	L (mm)	A (mm)	Max. Bundle Ø (mm)	Min. Loop Tensile Strength (kg)	Quantity
GR100X7.6N	100	7,6	20	22,2	100
GR120X7.6N	120		30		
GR150X7.6N	150		35		
GR200X7.6N	200		50		
GR250X7.6N	250		66		
GR300X7.6N	300		80		
GR370X7.6N	370		102		

Recommended tools are shown on page 258

The dimensions shown in the table must be considered as nominal. Cembre reserves the right to make changes without prior notice

GFH

CABLE TIES

GFH series, PA6.6 Polyamide



HF
HALOGEN FREE

Same features as G series.
Quick and easy identification of bundled conductors.
Write on panel with Felt tip pen.

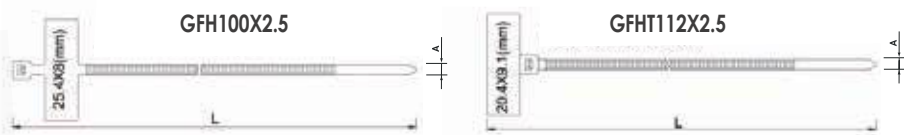

Markable cable ties in PA6.6

Type	L (mm)	A (mm)	Max. Bundle Ø (mm)	Min. Loop Tensile Strength (kg)	Quantity
GFH100X2.5	100	2,5	18	8,1	100
GFHT112X2.5	112				

Recommended tools are shown on page 258

The dimensions shown in the table must be considered as nominal. Cembre reserves the right to make changes without prior notice

1600

CABLE TIES

1600 series, Elastomerized Polymer on Polyamide base



HF
HALOGEN FREE

Resistant to: UV, salt atmosphere, oils, greases, oil products
Colour: Black

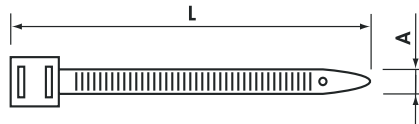

Cable Ties in PA12 Polyamide

Type	Head Type	L (mm)	A (mm)	Min. Bundle Ø (mm)	Max. Bundle Ø (mm)	Min. Loop Tensile Strength (kg)	Quantity
1618.90	single	180	9	15	40	40	100
1626.90	double	260	9	30	60	55	100
1636.90	double	360	9	30	93	55	100
1651.90	double	510	9	70	140	55	100
1676.90	double	760	9	70	220	55	100

Recommended tools are shown on page 258

The dimensions shown in the table must be considered as nominal. Cembre reserves the right to make changes without prior notice

Material: Elastomerized Polymer on Polyamide base
Self-extinguishing HB (UL94)
Halogen free
Operating temperature:
From -45°C to +85°C (continuous)
From -45°C to +120°C (short periods)

CABLE TIES

GX

GX series, in Stainless Steel AISI 304

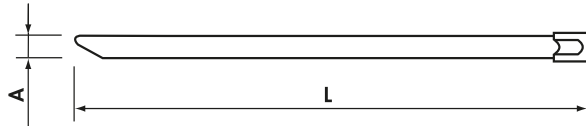

Cable Ties in Stainless Steel

Type	L (mm)	A (mm)	Max. Bundle Ø (mm)	Min. Loop Tensile Strength (kg)	Quantity
GX200X4.5	200	4,5	50	46	100
GX300X4.5	300		76		
GX370X4.5	370		102		
GX520X4.5	520		156		
GX370X7.9	370	7,9	102	114	
GX680X7.9	680		207		
GX1020X7.9	1020		312		

Recommended tools are shown on page 258

The dimensions shown in the table must be considered as nominal. Cembre reserves the right to make changes without prior notice

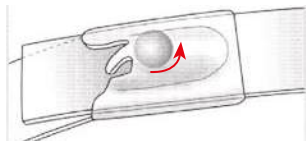

Insert the tongue into the buckle. The internal locking ball rolls freely as the tie is tightened.

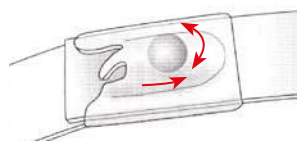

Once the correct tension is reached, use the specific tool to trim the tongue. The ball then wedges into the buckle locking it tightly against both the top and bottom of the tie.



Material: Stainless Steel AISI 304
 Unique ball locking mechanism that allows simple and rapid installation and secure locking.
 Operating temperature: From -80°C to +500°C
 High tensile strength.
 Non-flammability.
 High resistance to acetic acid, alkalies, sulphuric acid, corrosion, etc.
 In general very resistant to most hostile environments.

CABLE TIES

GXAC

GXAC series, 316 Stainless Steel coated with Polyester

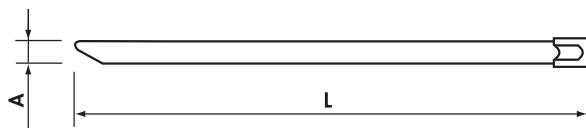

Coated Stainless Steel cable ties

Type	L (mm)	A (mm)	Max. Bundle Ø (mm)	Min. Loop Tensile Strength (kg)	Quantity
GXAC125X4.6	125	4,6	38,0	46	100
GXAC150X4.6	150		46,0		
GXAC200X4.6	200		61,9		
GXAC260X4.6	260		81,0		
GXAC290X4.6	290		90,6		
GXAC360X4.6	360		112,8		
GXAC520X4.6	520		163,8		
GXAC680X4.6	680		214,8		
GXAC840X4.6	840		265,7		
GXAC200X7.9	200		7,9		
GXAC290X7.9	290	90,6			
GXAC360X7.9	360	112,8			
GXAC520X7.9	520	163,8			
GXAC680X7.9	680	214,8			
GXAC840X7.9	840	265,7			

Recommended tools are shown on page 258

The dimensions shown in the table must be considered as nominal. Cembre reserves the right to make changes without prior notice

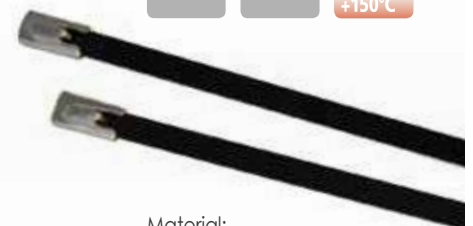

Material: 316 stainless steel for the most corrosive environments coated with Polyester for insulation purpose, and a better outdoor application
 Colour: Black
 Smooth surface and rounded edges assures cable protection and user safety. Equipped with unique ball locking mechanism that allows simple and rapid installation and secure locking.
 Operating temperature: da -40°C a +150°C
 High tensile strength
 Very resistant to ultraviolet radiation and chemical corrosion
 Non flammable

PA6.6 Polyamide

PA 6.6



Material: PA6.6 Polyamide
 Self-extinguishing V2 (UL 94)
 Humidity absorption:
 2,5% (at 50% relative humidity)
 Operating temperature:
 From -40°C to +85°C (continuous)
 From -40°C to +120°C (short periods)

Resistant to:
 oils, bases, greases, oil products,
 chlorinated solvents.
 Colour: Natural

Attention:
 acrylic adhesive; to obtain the best
 result, wait at least 6 - 8 hours be-
 fore applying the load.

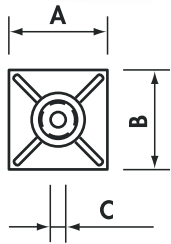

Self adhesive cable tie bases in PA6.6

Type	Max Tie (mm)	A (mm)	B (mm)	C (mm)	H (mm)	Fixing screw hole Ø (mm)	Quantity
AB13*	2,8	13,0	13,0	3,2	3,2	-	100
AB19*	3,6	19,0	19,0	4,0	4,4	3,1	100
AB28*	4,8	28,0	28,0	5,3	5,7	5,5	100

*Add to Ref: N for Black

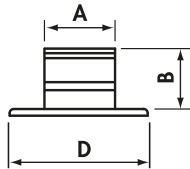
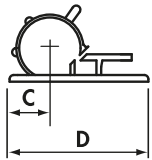

Self adhesive cable clips in PA6.6

Type	Cable Ø (mm)	A (mm)	B (mm)	C (mm)	D (mm)	Quantity
CC8.9	8-9	9,0	12,0	8,0	21,5	100
CC9.12	9-12	12,0	15,0	8,2	21,5	100

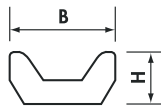
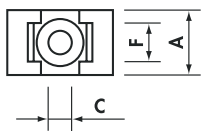

Cable tie saddle clamps in PA6.6

Type	Max Tie (mm)	A (mm)	B (mm)	C (mm)	F (mm)	H (mm)	Quantity
SS4.8-3.7	4,8	9,5	15	3,7	5,0	7,2	100
SS4.8-4.5	4,8	9,5	15	4,5	5,0	7,2	100
SS9-4.5	9	16,0	22	4,5	9,2	9,7	100
SS9-5	9	16,0	22	5,0	9,2	9,7	100
SS9-6.4	9	16,0	22	6,4	9,2	9,7	100



GH8

ACCESSORIES

PA6.6 Polyamide

PA 6.6



Same features as G series.
 Push into Ø 8 mm hole.
 Cable tie inserted through slot in
 head.

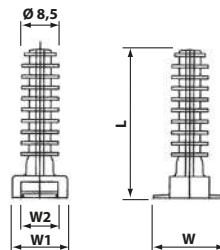

Stud fixing for cable ties in PA6.6

Type	W (mm)	W1 (mm)	W2 (mm)	L (mm)	Fixing hole Ø (mm)	Quantity
GH8	20	15	10	40,5	8	100

INSULATED COVERS

ES

For uninsulated connectors

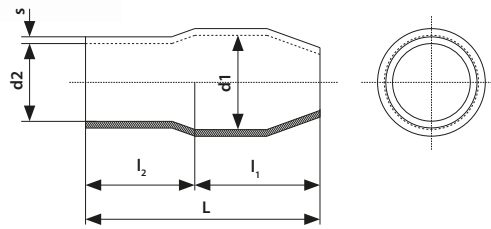

Insulated covers in PVC for general use with Cembre A-M copper tube lugs characterised by environmental tolerance, flexibility, not inflammability & stable performance. Widely used for the insulation and protection of connections and electrical terminations.

General features:

- Material: PVC
- Self extinguishing (UL94): V0
- Working temperature: 85 °C
- Colours: red, yellow, blue, black, grey, brown.

Type	Connectors A-M*	d1 Ø	d2 Ø	l1 ±1	l2 ±1	L ±2	s ±0.2	Quantity	Minimum Order Qty
ES03-..	A03	3.3	3.1	7.0	8.0	15.0	0.6	100	3,000
ES06-..	A06	4.5	3.7	8.0	8.0	16.0	0.7	100	
ES1-..	A1	5.7	4.1	9.0	9.0	18.0	0.8	100	
ES2-..	A2	7.2	6.2	11.0	10.0	21.0	1.0	100	1,000
ES3-..	A3	10.0	8.0	15.0	13.0	28.0	1.1	100	
ES5-..	A5	12.0	9.5	15.0	14.0	29.0	1.2	100	
ES10-..	A7, A9, A10	14.0	11.8	17.0	17.0	34.0	1.4	100	500
ES14-..	A12, A14	17.0	13.9	22.0	20.0	42.0	1.5	100	
ES19-..	A17, A19	19.0	16.0	25.0	21.0	46.0	1.5	50	
ES24-..	A20, A24	22.0	18.0	31.0	24.0	55.0	1.7	50	200
ES30-..	A29, A30	24.0	20.0	32.0	28.0	60.0	1.8	50	
ES37-..	A35, A37	26.0	22.0	34.0	31.0	65.0	1.8	50	
ES40-..	A40	32.2	24.0	38.0	31.0	69.0	2.0	50	100
ES48-..	A48	36.5	27.2	42.0	33.0	75.0	2.0	50	
ES80-..	A60, A80	36.7	30.0	42.0	33.0	75.0	2.0	25	

Add the suffix corresponding to the selected colour to the reference:

-BU blue, -GY grey, -BR brown, -BK black, -RE red, -YE yellow,

* See A-M type copper tube lugs on pages 28-29, 31
 ** Depending on the diameter of the insulated cable



Heat-shrinkable Polyolefin tubing coil for general use; is environmentally neutral, flexible, not inflammable and offers fast heat shrinkage and stable performance.

Main uses include insulation and protection of electrical conductors, connectors and terminations; protection of metal tubes from corrosion; protection of antennae and various identification applications.

For general characteristics and technical specifications see page 254.

- Colours: Black, Red, White, Blue, Transparent, Yellow, Green, Grey, Brown, Yellow/Green.
- Packaging: Coil on Reel

Type	Coil Length	before shrinking	after shrinking		Colour	
		Internal Ø mm	Internal Ø mm	Thickness mm		
TCS12X200BK	200 m	Ø 1,1 mm	Ø 0,50 mm	0,33 mm	BLACK	●
TCS16X200BK	200 m	Ø 1,5 mm	Ø 0,65 mm	0,36 mm	BLACK	●
TCS24X200BK	200 m	Ø 2,5 mm	Ø 1,00 mm	0,45 mm	BLACK	●
TCS32X200BK	200 m	Ø 3,0 mm	Ø 1,30 mm	0,45 mm	BLACK	●
TCS48X100BK	100 m	Ø 4,7 mm	Ø 2,00 mm	0,45 mm	BLACK	●
TCS64X100BK	100 m	Ø 6,5 mm	Ø 3,00 mm	0,56 mm	BLACK	●
TCS95X100BK	100 m	Ø 9,5 mm	Ø 4,50 mm	0,56 mm	BLACK	●
TCS127X100BK	100 m	Ø 12,5 mm	Ø 6,00 mm	0,56 mm	BLACK	●
TCS160X100BK	100 m	Ø 16,5 mm	Ø 8,00 mm	0,70 mm	BLACK	●
TCS190X100BK	100 m	Ø 19,0 mm	Ø 9,00 mm	0,70 mm	BLACK	●
TCS254X50BK	50 m	Ø 26,0 mm	Ø 12,5 mm	0,90 mm	BLACK	●
TCS320X50BK	50 m	Ø 31,5 mm	Ø 15,0 mm	1,00 mm	BLACK	●
TCS381X50BK	50 m	Ø 36,5 mm	Ø 17,5 mm	1,00 mm	BLACK	●
TCS508X25BK	25 m	Ø 50,0 mm	Ø 25,0 mm	1,10 mm	BLACK	●
TCS762X25BK	25 m	Ø 70,0 mm	Ø 36,0 mm	1,30 mm	BLACK	●
TCS1016X25BK	25 m	Ø 100,0 mm	Ø 51,0 mm	1,30 mm	BLACK	●
TCS1260X25BK	25 m	Ø 120,0 mm	Ø 61,0 mm	1,30 mm	BLACK	●
TCS1500X25BK	25 m	Ø 150,0 mm	Ø 76,0 mm	1,30 mm	BLACK	●
TCS16X200RE	200 m	Ø 1,5 mm	Ø 0,65 mm	0,36 mm	RED	●
TCS24X200RE	200 m	Ø 2,5 mm	Ø 1,00 mm	0,45 mm	RED	●
TCS32X200RE	200 m	Ø 3,0 mm	Ø 1,30 mm	0,45 mm	RED	●
TCS48X100RE	100 m	Ø 4,7 mm	Ø 2,00 mm	0,45 mm	RED	●
TCS64X100RE	100 m	Ø 6,5 mm	Ø 3,00 mm	0,56 mm	RED	●
TCS95X100RE	100 m	Ø 9,5 mm	Ø 4,50 mm	0,56 mm	RED	●
TCS127X100RE	100 m	Ø 12,5 mm	Ø 6,00 mm	0,56 mm	RED	●
TCS190X100RE	100 m	Ø 19,0 mm	Ø 9,00 mm	0,70 mm	RED	●
TCS254X50RE	50 m	Ø 26,0 mm	Ø 12,5 mm	0,90 mm	RED	●
TCS16X200WH	200 m	Ø 1,5 mm	Ø 0,65 mm	0,36 mm	WHITE	○
TCS20X200WH	200 m	Ø 2,0 mm	Ø 0,85 mm	0,36 mm	WHITE	○
TCS24X200WH	200 m	Ø 2,5 mm	Ø 1,00 mm	0,45 mm	WHITE	○
TCS32X200WH	200 m	Ø 3,0 mm	Ø 1,30 mm	0,45 mm	WHITE	○
TCS48X100WH	100 m	Ø 4,7 mm	Ø 2,00 mm	0,45 mm	WHITE	○
TCS64X100WH	100 m	Ø 6,5 mm	Ø 3,00 mm	0,56 mm	WHITE	○
TCS95X100WH	100 m	Ø 9,5 mm	Ø 4,50 mm	0,56 mm	WHITE	○
TCS127X100WH	100 m	Ø 12,5 mm	Ø 6,00 mm	0,56 mm	WHITE	○
TCS190X100WH	100 m	Ø 19,0 mm	Ø 9,00 mm	0,70 mm	WHITE	○
TCS254X50WH	50 m	Ø 26,0 mm	Ø 12,5 mm	0,90 mm	WHITE	○
TCS16X200BU	200 m	Ø 1,5 mm	Ø 0,65 mm	0,36 mm	BLUE	●
TCS24X200BU	200 m	Ø 2,5 mm	Ø 1,00 mm	0,45 mm	BLUE	●
TCS32X200BU	200 m	Ø 3,0 mm	Ø 1,30 mm	0,45 mm	BLUE	●
TCS48X100BU	100 m	Ø 4,7 mm	Ø 2,00 mm	0,45 mm	BLUE	●
TCS64X100BU	100 m	Ø 6,5 mm	Ø 3,00 mm	0,56 mm	BLUE	●
TCS95X100BU	100 m	Ø 9,5 mm	Ø 4,50 mm	0,56 mm	BLUE	●
TCS127X100BU	100 m	Ø 12,5 mm	Ø 6,00 mm	0,56 mm	BLUE	●
TCS190X100BU	100 m	Ø 19,0 mm	Ø 9,00 mm	0,70 mm	BLUE	●
TCS254X50BU	50 m	Ø 26,0 mm	Ø 12,5 mm	0,90 mm	BLUE	●
TCS381X50BU	50 m	Ø 36,5 mm	Ø 17,5 mm	1,00 mm	BLUE	●
TCS508X25BU	25 m	Ø 50,0 mm	Ø 25,0 mm	1,10 mm	BLUE	●

TERMOCOIL HEAT-SHRINKABLE TUBING

TCS

flame-retardant Polyolefin - shrinkage ratio 2÷1



Type	Coil Length	before shrinking		after shrinking		Colour
		Internal Ø mm	Internal Ø mm	Thickness mm		
TCS12X200TR	200 m	Ø 1,1 mm	Ø 0,50 mm	0,33 mm	TRANSPARENT	○
TCS16X200TR	200 m	Ø 1,5 mm	Ø 0,65 mm	0,36 mm	TRANSPARENT	○
TCS24X200TR	200 m	Ø 2,5 mm	Ø 1,00 mm	0,45 mm	TRANSPARENT	○
TCS32X200TR	200 m	Ø 3,0 mm	Ø 1,30 mm	0,45 mm	TRANSPARENT	○
TCS48X100TR	100 m	Ø 4,7 mm	Ø 2,00 mm	0,45 mm	TRANSPARENT	○
TCS64X100TR	100 m	Ø 6,5 mm	Ø 3,00 mm	0,56 mm	TRANSPARENT	○
TCS95X100TR	100 m	Ø 9,5 mm	Ø 4,50 mm	0,56 mm	TRANSPARENT	○
TCS127X100TR	100 m	Ø 12,5 mm	Ø 6,00 mm	0,56 mm	TRANSPARENT	○
TCS160X100TR	100 m	Ø 16,5 mm	Ø 8,00 mm	0,70 mm	TRANSPARENT	○
TCS190X100TR	100 m	Ø 19,0 mm	Ø 9,00 mm	0,70 mm	TRANSPARENT	○
TCS254X50TR	50 m	Ø 26,0 mm	Ø 12,5 mm	0,90 mm	TRANSPARENT	○
TCS320X50BK	50 m	Ø 31,5 mm	Ø 15,0 mm	1,00 mm	TRANSPARENT	○
TCS381X50TR	50 m	Ø 36,5 mm	Ø 17,5 mm	1,00 mm	TRANSPARENT	○
TCS508X25TR	25 m	Ø 50,0 mm	Ø 25,0 mm	1,10 mm	TRANSPARENT	○
TCS762X25TR	25 m	Ø 70,0 mm	Ø 36,0 mm	1,30 mm	TRANSPARENT	○
TCS1016X25TR	25 m	Ø 100,0 mm	Ø 51,0 mm	1,30 mm	TRANSPARENT	○
TCS1260X25TR	25 m	Ø 120,0 mm	Ø 61,0 mm	1,30 mm	TRANSPARENT	○
TCS1500X25TR	25 m	Ø 150,0 mm	Ø 76,0 mm	1,30 mm	TRANSPARENT	○
TCS16X200YE	200 m	Ø 1,5 mm	Ø 0,65 mm	0,36 mm	YELLOW	●
TCS24X200YE	200 m	Ø 2,5 mm	Ø 1,00 mm	0,45 mm	YELLOW	●
TCS32X200YE	200 m	Ø 3,0 mm	Ø 1,30 mm	0,45 mm	YELLOW	●
TCS48X100YE	100 m	Ø 4,7 mm	Ø 2,00 mm	0,45 mm	YELLOW	●
TCS64X100YE	100 m	Ø 6,5 mm	Ø 3,00 mm	0,56 mm	YELLOW	●
TCS95X100YE	100 m	Ø 9,5 mm	Ø 4,50 mm	0,56 mm	YELLOW	●
TCS127X100YE	100 m	Ø 12,5 mm	Ø 6,00 mm	0,56 mm	YELLOW	●
TCS190X100YE	100 m	Ø 19,0 mm	Ø 9,00 mm	0,70 mm	YELLOW	●
TCS254X50YE	50 m	Ø 26,0 mm	Ø 12,5 mm	0,90 mm	YELLOW	●
TCS16X200GN	200 m	Ø 1,5 mm	Ø 0,65 mm	0,36 mm	GREEN	●
TCS24X200GN	200 m	Ø 2,5 mm	Ø 1,00 mm	0,45 mm	GREEN	●
TCS32X200GN	200 m	Ø 3,0 mm	Ø 1,30 mm	0,45 mm	GREEN	●
TCS48X100GN	100 m	Ø 4,7 mm	Ø 2,00 mm	0,45 mm	GREEN	●
TCS64X100GN	100 m	Ø 6,5 mm	Ø 3,00 mm	0,56 mm	GREEN	●
TCS95X100GN	100 m	Ø 9,5 mm	Ø 4,50 mm	0,56 mm	GREEN	●
TCS127X100GN	100 m	Ø 12,5 mm	Ø 6,00 mm	0,56 mm	GREEN	●
TCS190X100GN	100 m	Ø 19,0 mm	Ø 9,00 mm	0,70 mm	GREEN	●
TCS254X50GN	50 m	Ø 26,0 mm	Ø 12,5 mm	0,90 mm	GREEN	●
TCS16X200GY	200 m	Ø 1,5 mm	Ø 0,65 mm	0,36 mm	GREY	●
TCS24X200GY	200 m	Ø 2,5 mm	Ø 1,00 mm	0,45 mm	GREY	●
TCS32X200GY	200 m	Ø 3,0 mm	Ø 1,30 mm	0,45 mm	GREY	●
TCS48X100GY	100 m	Ø 4,7 mm	Ø 2,00 mm	0,45 mm	GREY	●
TCS64X100GY	100 m	Ø 6,5 mm	Ø 3,00 mm	0,56 mm	GREY	●
TCS95X100GY	100 m	Ø 9,5 mm	Ø 4,50 mm	0,56 mm	GREY	●
TCS127X100GY	100 m	Ø 12,5 mm	Ø 6,00 mm	0,56 mm	GREY	●
TCS190X100GY	100 m	Ø 19,0 mm	Ø 9,00 mm	0,70 mm	GREY	●
TCS254X50GY	50 m	Ø 26,0 mm	Ø 12,5 mm	0,90 mm	GREY	●
TCS381X50GY	50 m	Ø 36,5 mm	Ø 17,5 mm	1,00 mm	GREY	●
TCS508X25GY NEW	25 m	Ø 50,0 mm	Ø 25,0 mm	1,10 mm	GREY	●
TCS16X200BR	200 m	Ø 1,5 mm	Ø 0,65 mm	0,36 mm	BROWN	●
TCS24X200BR	200 m	Ø 2,5 mm	Ø 1,00 mm	0,45 mm	BROWN	●
TCS32X200BR	200 m	Ø 3,0 mm	Ø 1,30 mm	0,45 mm	BROWN	●
TCS48X100BR	100 m	Ø 4,7 mm	Ø 2,00 mm	0,45 mm	BROWN	●
TCS64X100BR	100 m	Ø 6,5 mm	Ø 3,00 mm	0,56 mm	BROWN	●
TCS95X100BR	100 m	Ø 9,5 mm	Ø 4,50 mm	0,56 mm	BROWN	●
TCS127X100BR	100 m	Ø 12,5 mm	Ø 6,00 mm	0,56 mm	BROWN	●
TCS190X100BR	100 m	Ø 19,0 mm	Ø 9,00 mm	0,70 mm	BROWN	●
TCS254X50BR	50 m	Ø 26,0 mm	Ø 12,5 mm	0,90 mm	BROWN	●
TCS381X50BR	50 m	Ø 36,5 mm	Ø 17,5 mm	1,00 mm	BROWN	●
TCS508X25BR NEW	25 m	Ø 50,0 mm	Ø 25,0 mm	1,10 mm	BROWN	●
TCS32X200Y/G	200 m	Ø 3,0 mm	Ø 1,30 mm	0,45 mm	YELLOW/GREEN	●
TCS48X100Y/G	100 m	Ø 4,7 mm	Ø 2,00 mm	0,45 mm	YELLOW/GREEN	●
TCS64X100Y/G	100 m	Ø 6,5 mm	Ø 3,00 mm	0,56 mm	YELLOW/GREEN	●
TCS95X100Y/G	100 m	Ø 9,5 mm	Ø 4,50 mm	0,56 mm	YELLOW/GREEN	●
TCS127X100Y/G	100 m	Ø 12,5 mm	Ø 6,00 mm	0,56 mm	YELLOW/GREEN	●
TCS190X100Y/G	100 m	Ø 19,0 mm	Ø 9,00 mm	0,70 mm	YELLOW/GREEN	●
TCS254X50Y/G	50 m	Ø 26,0 mm	Ø 12,5 mm	0,90 mm	YELLOW/GREEN	●
TCS381X50Y/G	50 m	Ø 36,5 mm	Ø 17,5 mm	1,00 mm	YELLOW/GREEN	●
TCS508X25Y/G	25 m	Ø 50,0 mm	Ø 25,0 mm	1,10 mm	YELLOW/GREEN	●



Heat-shrinkable Polyolefin tubing strip for general use; is environmentally neutral, flexible, not inflammable and offers fast heat shrinkage and stable performance.

Main uses include insulation and protection of electrical conductors, connectors and terminations; protection of metal tubes from corrosion; protection of antennae and various identification applications.

For general characteristics and technical specifications see page 254.

- Colours: Black, Red, White, Blue, Transparent, Yellow, Green, Grey, Brown, Yellow/Green.
- Packaging: Strips in Box

Type	Strip Length	before shrinking		after shrinking		Colour	Quantity Strips per box
		Internal Ø mm	Internal Ø mm	Thickness mm	Thickness mm		
TSS12BK	1,22 m	Ø 1,1 mm	Ø 0,5 mm	0,33 mm	0,33 mm	BLACK ●	30
TSS16BK	1,22 m	Ø 1,5 mm	Ø 0,65 mm	0,36 mm	0,36 mm	BLACK ●	30
TSS24BK	1,22 m	Ø 2,5 mm	Ø 1,00 mm	0,45 mm	0,45 mm	BLACK ●	30
TSS32BK	1,22 m	Ø 3,0 mm	Ø 1,30 mm	0,45 mm	0,45 mm	BLACK ●	30
TSS48BK	1,22 m	Ø 4,7 mm	Ø 2,00 mm	0,45 mm	0,45 mm	BLACK ●	30
TSS64BK	1,22 m	Ø 6,5 mm	Ø 3,00 mm	0,56 mm	0,56 mm	BLACK ●	30
TSS95BK	1,22 m	Ø 9,5 mm	Ø 4,50 mm	0,56 mm	0,56 mm	BLACK ●	20
TSS127BK	1,22 m	Ø 12,5 mm	Ø 6,00 mm	0,56 mm	0,56 mm	BLACK ●	15
TSS190BK	1,22 m	Ø 19,0 mm	Ø 9,00 mm	0,70 mm	0,70 mm	BLACK ●	10
TSS254BK	1,22 m	Ø 26,0 mm	Ø 12,5 mm	0,90 mm	0,90 mm	BLACK ●	6
TSS380BK	1,22 m	Ø 36,5 mm	Ø 17,5 mm	1,00 mm	1,00 mm	BLACK ●	4
TSS510BK	1,22 m	Ø 50,0 mm	Ø 25,0 mm	1,10 mm	1,10 mm	BLACK ●	2
TSS12RE	1,22 m	Ø 1,1 mm	Ø 0,5 mm	0,33 mm	0,33 mm	RED ●	30
TSS16RE	1,22 m	Ø 1,5 mm	Ø 0,65 mm	0,36 mm	0,36 mm	RED ●	30
TSS24RE	1,22 m	Ø 2,5 mm	Ø 1,00 mm	0,45 mm	0,45 mm	RED ●	30
TSS32RE	1,22 m	Ø 3,0 mm	Ø 1,30 mm	0,45 mm	0,45 mm	RED ●	30
TSS48RE	1,22 m	Ø 4,7 mm	Ø 2,00 mm	0,45 mm	0,45 mm	RED ●	30
TSS64RE	1,22 m	Ø 6,5 mm	Ø 3,00 mm	0,56 mm	0,56 mm	RED ●	30
TSS95RE	1,22 m	Ø 9,5 mm	Ø 4,50 mm	0,56 mm	0,56 mm	RED ●	20
TSS127RE	1,22 m	Ø 12,5 mm	Ø 6,00 mm	0,56 mm	0,56 mm	RED ●	15
TSS190RE	1,22 m	Ø 19,0 mm	Ø 9,00 mm	0,70 mm	0,70 mm	RED ●	10
TSS254RE	1,22 m	Ø 26,0 mm	Ø 12,5 mm	0,90 mm	0,90 mm	RED ●	6
TSS380RE	1,22 m	Ø 36,5 mm	Ø 17,5 mm	1,00 mm	1,00 mm	RED ●	4
TSS510RE	1,22 m	Ø 50,0 mm	Ø 25,0 mm	1,10 mm	1,10 mm	RED ●	2
TSS12WH	1,22 m	Ø 1,1 mm	Ø 0,5 mm	0,33 mm	0,33 mm	WHITE ○	30
TSS16WH	1,22 m	Ø 1,5 mm	Ø 0,65 mm	0,36 mm	0,36 mm	WHITE ○	30
TSS24WH	1,22 m	Ø 2,5 mm	Ø 1,00 mm	0,45 mm	0,45 mm	WHITE ○	30
TSS32WH	1,22 m	Ø 3,0 mm	Ø 1,30 mm	0,45 mm	0,45 mm	WHITE ○	30
TSS48WH	1,22 m	Ø 4,7 mm	Ø 2,00 mm	0,45 mm	0,45 mm	WHITE ○	30
TSS64WH	1,22 m	Ø 6,5 mm	Ø 3,00 mm	0,56 mm	0,56 mm	WHITE ○	30
TSS95WH	1,22 m	Ø 9,5 mm	Ø 4,50 mm	0,56 mm	0,56 mm	WHITE ○	20
TSS127WH	1,22 m	Ø 12,5 mm	Ø 6,00 mm	0,56 mm	0,56 mm	WHITE ○	15
TSS190WH	1,22 m	Ø 19,0 mm	Ø 9,00 mm	0,70 mm	0,70 mm	WHITE ○	10
TSS254WH	1,22 m	Ø 26,0 mm	Ø 12,5 mm	0,90 mm	0,90 mm	WHITE ○	6
TSS380WH	1,22 m	Ø 36,5 mm	Ø 17,5 mm	1,00 mm	1,00 mm	WHITE ○	4
TSS510WH	1,22 m	Ø 50,0 mm	Ø 25,0 mm	1,10 mm	1,10 mm	WHITE ○	2
TSS12BU	1,22 m	Ø 1,1 mm	Ø 0,5 mm	0,33 mm	0,33 mm	BLUE ●	30
TSS16BU	1,22 m	Ø 1,5 mm	Ø 0,65 mm	0,36 mm	0,36 mm	BLUE ●	30
TSS24BU	1,22 m	Ø 2,5 mm	Ø 1,00 mm	0,45 mm	0,45 mm	BLUE ●	30
TSS32BU	1,22 m	Ø 3,0 mm	Ø 1,30 mm	0,45 mm	0,45 mm	BLUE ●	30
TSS48BU	1,22 m	Ø 4,7 mm	Ø 2,00 mm	0,45 mm	0,45 mm	BLUE ●	30
TSS64BU	1,22 m	Ø 6,5 mm	Ø 3,00 mm	0,56 mm	0,56 mm	BLUE ●	30
TSS95BU	1,22 m	Ø 9,5 mm	Ø 4,50 mm	0,56 mm	0,56 mm	BLUE ●	20
TSS127BU	1,22 m	Ø 12,5 mm	Ø 6,00 mm	0,56 mm	0,56 mm	BLUE ●	15
TSS190BU	1,22 m	Ø 19,0 mm	Ø 9,00 mm	0,70 mm	0,70 mm	BLUE ●	10
TSS254BU	1,22 m	Ø 26,0 mm	Ø 12,5 mm	0,90 mm	0,90 mm	BLUE ●	6
TSS380BU	1,22 m	Ø 36,5 mm	Ø 17,5 mm	1,00 mm	1,00 mm	BLUE ●	4
TSS510BU	1,22 m	Ø 50,0 mm	Ø 25,0 mm	1,10 mm	1,10 mm	BLUE ●	2
TSS12TR	1,22 m	Ø 1,1 mm	Ø 0,5 mm	0,33 mm	0,33 mm	TRANSPARENT ○	30
TSS16TR	1,22 m	Ø 1,5 mm	Ø 0,65 mm	0,36 mm	0,36 mm	TRANSPARENT ○	30
TSS24TR	1,22 m	Ø 2,5 mm	Ø 1,00 mm	0,45 mm	0,45 mm	TRANSPARENT ○	30
TSS32TR	1,22 m	Ø 3,0 mm	Ø 1,30 mm	0,45 mm	0,45 mm	TRANSPARENT ○	30
TSS48TR	1,22 m	Ø 4,7 mm	Ø 2,00 mm	0,45 mm	0,45 mm	TRANSPARENT ○	30
TSS64TR	1,22 m	Ø 6,5 mm	Ø 3,00 mm	0,56 mm	0,56 mm	TRANSPARENT ○	30
TSS95TR	1,22 m	Ø 9,5 mm	Ø 4,50 mm	0,56 mm	0,56 mm	TRANSPARENT ○	20
TSS127TR	1,22 m	Ø 12,5 mm	Ø 6,00 mm	0,56 mm	0,56 mm	TRANSPARENT ○	15
TSS190TR	1,22 m	Ø 19,0 mm	Ø 9,00 mm	0,70 mm	0,70 mm	TRANSPARENT ○	10
TSS254TR	1,22 m	Ø 26,0 mm	Ø 12,5 mm	0,90 mm	0,90 mm	TRANSPARENT ○	6
TSS380TR	1,22 m	Ø 36,5 mm	Ø 17,5 mm	1,00 mm	1,00 mm	TRANSPARENT ○	4
TSS510TR	1,22 m	Ø 50,0 mm	Ø 25,0 mm	1,10 mm	1,10 mm	TRANSPARENT ○	2

TERMOSTRIP HEAT-SHRINKABLE TUBING

TSS

flame-retardant Polyolefin - shrinkage ratio 2÷1



Type	Strip Length	before shrinking		after shrinking		Colour	Quantity Strips per box
		Internal Ø mm	Internal Ø mm	Thickness mm	Thickness mm		
TSS12YE	1,22 m	Ø 1,1 mm	Ø 0,5 mm	0,33 mm	0,33 mm	YELLOW	30
TSS16YE	1,22 m	Ø 1,5 mm	Ø 0,65 mm	0,36 mm	0,36 mm	YELLOW	30
TSS24YE	1,22 m	Ø 2,5 mm	Ø 1,00 mm	0,45 mm	0,45 mm	YELLOW	30
TSS32YE	1,22 m	Ø 3,0 mm	Ø 1,30 mm	0,45 mm	0,45 mm	YELLOW	30
TSS48YE	1,22 m	Ø 4,7 mm	Ø 2,00 mm	0,45 mm	0,45 mm	YELLOW	30
TSS64YE	1,22 m	Ø 6,5 mm	Ø 3,00 mm	0,56 mm	0,56 mm	YELLOW	30
TSS95YE	1,22 m	Ø 9,5 mm	Ø 4,50 mm	0,56 mm	0,56 mm	YELLOW	20
TSS127YE	1,22 m	Ø 12,5 mm	Ø 6,00 mm	0,56 mm	0,56 mm	YELLOW	15
TSS190YE	1,22 m	Ø 19,0 mm	Ø 9,00 mm	0,70 mm	0,70 mm	YELLOW	10
TSS254YE	1,22 m	Ø 26,0 mm	Ø 12,5 mm	0,90 mm	0,90 mm	YELLOW	6
TSS380YE	1,22 m	Ø 36,5 mm	Ø 17,5 mm	1,00 mm	1,00 mm	YELLOW	4
TSS510YE	1,22 m	Ø 50,0 mm	Ø 25,0 mm	1,10 mm	1,10 mm	YELLOW	2
TSS12GN	1,22 m	Ø 1,1 mm	Ø 0,5 mm	0,33 mm	0,33 mm	GREEN	30
TSS16GN	1,22 m	Ø 1,5 mm	Ø 0,65 mm	0,36 mm	0,36 mm	GREEN	30
TSS24GN	1,22 m	Ø 2,5 mm	Ø 1,00 mm	0,45 mm	0,45 mm	GREEN	30
TSS32GN	1,22 m	Ø 3,0 mm	Ø 1,30 mm	0,45 mm	0,45 mm	GREEN	30
TSS48GN	1,22 m	Ø 4,7 mm	Ø 2,00 mm	0,45 mm	0,45 mm	GREEN	30
TSS64GN	1,22 m	Ø 6,5 mm	Ø 3,00 mm	0,56 mm	0,56 mm	GREEN	30
TSS95GN	1,22 m	Ø 9,5 mm	Ø 4,50 mm	0,56 mm	0,56 mm	GREEN	20
TSS127GN	1,22 m	Ø 12,5 mm	Ø 6,00 mm	0,56 mm	0,56 mm	GREEN	15
TSS190GN	1,22 m	Ø 19,0 mm	Ø 9,00 mm	0,70 mm	0,70 mm	GREEN	10
TSS254GN	1,22 m	Ø 26,0 mm	Ø 12,5 mm	0,90 mm	0,90 mm	GREEN	6
TSS380GN	1,22 m	Ø 36,5 mm	Ø 17,5 mm	1,00 mm	1,00 mm	GREEN	4
TSS510GN	1,22 m	Ø 50,0 mm	Ø 25,0 mm	1,10 mm	1,10 mm	GREEN	2
TSS12GY	1,22 m	Ø 1,1 mm	Ø 0,5 mm	0,33 mm	0,33 mm	GREY	30
TSS16GY	1,22 m	Ø 1,5 mm	Ø 0,65 mm	0,36 mm	0,36 mm	GREY	30
TSS24GY	1,22 m	Ø 2,5 mm	Ø 1,00 mm	0,45 mm	0,45 mm	GREY	30
TSS32GY	1,22 m	Ø 3,0 mm	Ø 1,30 mm	0,45 mm	0,45 mm	GREY	30
TSS48GY	1,22 m	Ø 4,7 mm	Ø 2,00 mm	0,45 mm	0,45 mm	GREY	30
TSS64GY	1,22 m	Ø 6,5 mm	Ø 3,00 mm	0,56 mm	0,56 mm	GREY	30
TSS95GY	1,22 m	Ø 9,5 mm	Ø 4,50 mm	0,56 mm	0,56 mm	GREY	20
TSS127GY	1,22 m	Ø 12,5 mm	Ø 6,00 mm	0,56 mm	0,56 mm	GREY	15
TSS190GY	1,22 m	Ø 19,0 mm	Ø 9,00 mm	0,70 mm	0,70 mm	GREY	10
TSS254GY	1,22 m	Ø 26,0 mm	Ø 12,5 mm	0,90 mm	0,90 mm	GREY	6
TSS380GY	1,22 m	Ø 36,5 mm	Ø 17,5 mm	1,00 mm	1,00 mm	GREY	4
TSS510GY	1,22 m	Ø 50,0 mm	Ø 25,0 mm	1,10 mm	1,10 mm	GREY	2
TSS12BR	1,22 m	Ø 1,1 mm	Ø 0,5 mm	0,33 mm	0,33 mm	BROWN	30
TSS16BR	1,22 m	Ø 1,5 mm	Ø 0,65 mm	0,36 mm	0,36 mm	BROWN	30
TSS24BR	1,22 m	Ø 2,5 mm	Ø 1,00 mm	0,45 mm	0,45 mm	BROWN	30
TSS32BR	1,22 m	Ø 3,0 mm	Ø 1,30 mm	0,45 mm	0,45 mm	BROWN	30
TSS48BR	1,22 m	Ø 4,7 mm	Ø 2,00 mm	0,45 mm	0,45 mm	BROWN	30
TSS64BR	1,22 m	Ø 6,5 mm	Ø 3,00 mm	0,56 mm	0,56 mm	BROWN	30
TSS95BR	1,22 m	Ø 9,5 mm	Ø 4,50 mm	0,56 mm	0,56 mm	BROWN	20
TSS127BR	1,22 m	Ø 12,5 mm	Ø 6,00 mm	0,56 mm	0,56 mm	BROWN	15
TSS190BR	1,22 m	Ø 19,0 mm	Ø 9,00 mm	0,70 mm	0,70 mm	BROWN	10
TSS254BR	1,22 m	Ø 26,0 mm	Ø 12,5 mm	0,90 mm	0,90 mm	BROWN	6
TSS380BR	1,22 m	Ø 36,5 mm	Ø 17,5 mm	1,00 mm	1,00 mm	BROWN	4
TSS510BR	1,22 m	Ø 50,0 mm	Ø 25,0 mm	1,10 mm	1,10 mm	BROWN	2
TSS12Y/G	1,22 m	Ø 1,1 mm	Ø 0,5 mm	0,33 mm	0,33 mm	YELLOW/GREEN	30
TSS16Y/G	1,22 m	Ø 1,5 mm	Ø 0,65 mm	0,36 mm	0,36 mm	YELLOW/GREEN	30
TSS24Y/G	1,22 m	Ø 2,5 mm	Ø 1,00 mm	0,45 mm	0,45 mm	YELLOW/GREEN	30
TSS32Y/G	1,22 m	Ø 3,0 mm	Ø 1,30 mm	0,45 mm	0,45 mm	YELLOW/GREEN	30
TSS48Y/G	1,22 m	Ø 4,7 mm	Ø 2,00 mm	0,45 mm	0,45 mm	YELLOW/GREEN	30
TSS64Y/G	1,22 m	Ø 6,5 mm	Ø 3,00 mm	0,56 mm	0,56 mm	YELLOW/GREEN	30
TSS95Y/G	1,22 m	Ø 9,5 mm	Ø 4,50 mm	0,56 mm	0,56 mm	YELLOW/GREEN	20
TSS127Y/G	1,22 m	Ø 12,5 mm	Ø 6,00 mm	0,56 mm	0,56 mm	YELLOW/GREEN	15
TSS190Y/G	1,22 m	Ø 19,0 mm	Ø 9,00 mm	0,70 mm	0,70 mm	YELLOW/GREEN	10
TSS254Y/G	1,22 m	Ø 26,0 mm	Ø 12,5 mm	0,90 mm	0,90 mm	YELLOW/GREEN	6
TSS380Y/G	1,22 m	Ø 36,5 mm	Ø 17,5 mm	1,00 mm	1,00 mm	YELLOW/GREEN	4



Heat-shrinkable Polyolefin tubing for general use; is environmentally neutral, flexible, not inflammable and offers fast heat shrinkage and stable performance.

Main uses include insulation and protection of electrical conductors, connectors and terminations; protection of metal tubes from corrosion; protection of antennae and various identification applications.

General characteristics:

- Operating temperature: -55°C + 125°C
- Minimum shrinkage temperature: 70°C
- Temperature for complete shrinkage: 110°C
- RoHS compliant
- Colours: Black, Red, White, Blue, Grey, Brown, Yellow/Green.
- Packaging: Roll in Dispenser Box

Technical Specifications:

Property	Test Method	Performance
Traction resistance (MPa):	ASTM D2671	≥10.4
Elongation at failure (%):	ASTM D2671	≥200
Traction resistance after heat aging (MPa):	UL 224 158°Cx168hr	≥7.3
Elongation at failure after heat aging (%):	UL 224 158°Cx168hr	≥100
Heat resistance:	UL 224 250°Cx4hr	No failure
Low temperature flexibility:	UL 224 -30°Cx4hr	No failure
Dielectric strength (kv/mm):	IEC 243	≥15
Insulation resistance:	600V UL 224	No perforation at 2500V
Volume resistance (Ω.cm):	IEC 93	≥1x10 ¹⁴
Corrosive action:	UL 224 158°Cx168hr	Not corrosive
Copper compatibility:	UL 224 158°Cx168hr	Not corrosive
Flammability:	UL 224	VW-1

Type	Reel Length	before shrinking		after shrinking		Colour
		Internal Ø mm	Internal Ø mm	Thickness mm	Thickness mm	
TBS16X20BK	20 m	Ø 1,5 mm	Ø 0,65 mm	0,36 mm	0,36 mm	BLACK
TBS24X20BK	20 m	Ø 2,5 mm	Ø 1,00 mm	0,45 mm	0,45 mm	BLACK
TBS32X10BK	10 m	Ø 3,0 mm	Ø 1,30 mm	0,45 mm	0,45 mm	BLACK
TBS48X10BK	10 m	Ø 4,7 mm	Ø 2,00 mm	0,45 mm	0,45 mm	BLACK
TBS64X10BK	10 m	Ø 6,5 mm	Ø 3,00 mm	0,56 mm	0,56 mm	BLACK
TBS95X10BK	10 m	Ø 9,5 mm	Ø 4,50 mm	0,56 mm	0,56 mm	BLACK
TBS127X10BK	10 m	Ø 12,5 mm	Ø 6,00 mm	0,56 mm	0,56 mm	BLACK
TBS190X5BK	5 m	Ø 19,0 mm	Ø 9,00 mm	0,70 mm	0,70 mm	BLACK
TBS254X5BK	5 m	Ø 26,0 mm	Ø 12,5 mm	0,90 mm	0,90 mm	BLACK
TBS16X20RE	20 m	Ø 1,5 mm	Ø 0,65 mm	0,36 mm	0,36 mm	RED
TBS24X20RE	20 m	Ø 2,5 mm	Ø 1,00 mm	0,45 mm	0,45 mm	RED
TBS32X10RE	10 m	Ø 3,0 mm	Ø 1,30 mm	0,45 mm	0,45 mm	RED
TBS48X10RE	10 m	Ø 4,7 mm	Ø 2,00 mm	0,45 mm	0,45 mm	RED
TBS64X10RE	10 m	Ø 6,5 mm	Ø 3,00 mm	0,56 mm	0,56 mm	RED
TBS95X10RE	10 m	Ø 9,5 mm	Ø 4,50 mm	0,56 mm	0,56 mm	RED
TBS127X10RE	10 m	Ø 12,5 mm	Ø 6,00 mm	0,56 mm	0,56 mm	RED
TBS190X5RE	5 m	Ø 19,0 mm	Ø 9,00 mm	0,70 mm	0,70 mm	RED
TBS254X5RE	5 m	Ø 26,0 mm	Ø 12,5 mm	0,90 mm	0,90 mm	RED
TBS16X20WH	20 m	Ø 1,5 mm	Ø 0,65 mm	0,36 mm	0,36 mm	WHITE
TBS24X20WH	20 m	Ø 2,5 mm	Ø 1,00 mm	0,45 mm	0,45 mm	WHITE
TBS32X20WH	10 m	Ø 3,0 mm	Ø 1,30 mm	0,45 mm	0,45 mm	WHITE
TBS48X10WH	10 m	Ø 4,7 mm	Ø 2,00 mm	0,45 mm	0,45 mm	WHITE
TBS64X10WH	10 m	Ø 6,5 mm	Ø 3,00 mm	0,56 mm	0,56 mm	WHITE
TBS95X10WH	10 m	Ø 9,5 mm	Ø 4,50 mm	0,56 mm	0,56 mm	WHITE
TBS127X10WH	10 m	Ø 12,5 mm	Ø 6,00 mm	0,56 mm	0,56 mm	WHITE
TBS190X5WH	5 m	Ø 19,0 mm	Ø 9,00 mm	0,70 mm	0,70 mm	WHITE
TBS254X5WH	5 m	Ø 26,0 mm	Ø 12,5 mm	0,90 mm	0,90 mm	WHITE
TBS16X20BU	20 m	Ø 1,5 mm	Ø 0,65 mm	0,36 mm	0,36 mm	BLUE
TBS24X20BU	20 m	Ø 2,5 mm	Ø 1,00 mm	0,45 mm	0,45 mm	BLUE
TBS32X10BU	10 m	Ø 3,0 mm	Ø 1,30 mm	0,45 mm	0,45 mm	BLUE
TBS48X10BU	10 m	Ø 4,7 mm	Ø 2,00 mm	0,45 mm	0,45 mm	BLUE
TBS64X10BU	10 m	Ø 6,5 mm	Ø 3,00 mm	0,56 mm	0,56 mm	BLUE
TBS95X10BU	10 m	Ø 9,5 mm	Ø 4,50 mm	0,56 mm	0,56 mm	BLUE
TBS127X10BU	10 m	Ø 12,5 mm	Ø 6,00 mm	0,56 mm	0,56 mm	BLUE
TBS190X5BU	5 m	Ø 19,0 mm	Ø 9,00 mm	0,70 mm	0,70 mm	BLUE
TBS254X5BU	5 m	Ø 26,0 mm	Ø 12,5 mm	0,90 mm	0,90 mm	BLUE

Type	Reel Length	before shrinking		after shrinking		Colour
		Internal Ø mm	Internal Ø mm	Thickness mm	Thickness mm	
TBS16X20GY	20 m	Ø 1,5 mm	Ø 0,65 mm	0,36 mm	0,36 mm	GREY
TBS24X20GY	20 m	Ø 2,5 mm	Ø 1,00 mm	0,45 mm	0,45 mm	GREY
TBS32X10GY	10 m	Ø 3,0 mm	Ø 1,30 mm	0,45 mm	0,45 mm	GREY
TBS48X10GY	10 m	Ø 4,7 mm	Ø 2,00 mm	0,45 mm	0,45 mm	GREY
TBS64X10GY	10 m	Ø 6,5 mm	Ø 3,00 mm	0,56 mm	0,56 mm	GREY
TBS95X10GY	10 m	Ø 9,5 mm	Ø 4,50 mm	0,56 mm	0,56 mm	GREY
TBS127X10GY	10 m	Ø 12,5 mm	Ø 6,00 mm	0,56 mm	0,56 mm	GREY
TBS190X5GY	5 m	Ø 19,0 mm	Ø 9,00 mm	0,70 mm	0,70 mm	GREY
TBS254X5GY	5 m	Ø 26,0 mm	Ø 12,5 mm	0,90 mm	0,90 mm	GREY
TBS16X20BR	20 m	Ø 1,5 mm	Ø 0,65 mm	0,36 mm	0,36 mm	BROWN
TBS24X20BR	20 m	Ø 2,5 mm	Ø 1,00 mm	0,45 mm	0,45 mm	BROWN
TBS32X10BR	10 m	Ø 3,0 mm	Ø 1,30 mm	0,45 mm	0,45 mm	BROWN
TBS48X10BR	10 m	Ø 4,7 mm	Ø 2,00 mm	0,45 mm	0,45 mm	BROWN
TBS64X10BR	10 m	Ø 6,5 mm	Ø 3,00 mm	0,56 mm	0,56 mm	BROWN
TBS95X10BR	10 m	Ø 9,5 mm	Ø 4,50 mm	0,56 mm	0,56 mm	BROWN
TBS127X10BR	10 m	Ø 12,5 mm	Ø 6,00 mm	0,56 mm	0,56 mm	BROWN
TBS190X5BR	5 m	Ø 19,0 mm	Ø 9,00 mm	0,70 mm	0,70 mm	BROWN
TBS254X5BR	5 m	Ø 26,0 mm	Ø 12,5 mm	0,90 mm	0,90 mm	BROWN
TBS16X20Y/G	20 m	Ø 1,5 mm	Ø 0,65 mm	0,36 mm	0,36 mm	YELLOW/GREEN
TBS24X20Y/G	20 m	Ø 2,5 mm	Ø 1,00 mm	0,45 mm	0,45 mm	YELLOW/GREEN
TBS32X10Y/G	10 m	Ø 3,0 mm	Ø 1,30 mm	0,45 mm	0,45 mm	YELLOW/GREEN
TBS48X10Y/G	10 m	Ø 4,7 mm	Ø 2,00 mm	0,45 mm	0,45 mm	YELLOW/GREEN
TBS64X10Y/G	10 m	Ø 6,5 mm	Ø 3,00 mm	0,56 mm	0,56 mm	YELLOW/GREEN
TBS95X10Y/G	10 m	Ø 9,5 mm	Ø 4,50 mm	0,56 mm	0,56 mm	YELLOW/GREEN
TBS127X10Y/G	10 m	Ø 12,5 mm	Ø 6,00 mm	0,56 mm	0,56 mm	YELLOW/GREEN
TBS190X5Y/G	5 m	Ø 19,0 mm	Ø 9,00 mm	0,70 mm	0,70 mm	YELLOW/GREEN
TBS254X5Y/G	5 m	Ø 26,0 mm	Ø 12,5 mm	0,90 mm	0,90 mm	YELLOW/GREEN

CAST RESIN JOINTS

N

cast resin, low voltage through joints



Shells

Manufactured from transparent synthetic material which allows a visual check of the connections before and after casting. The halves of the shell are joined by snap closures which avoid further fixing or sealing.

Shells are left on after casting to provide additional protection against mechanical abrasion, chemical agents and severe weather conditions.



STRAIGHT JOINTS

Type	Dimensions mm				Dimensions Cable	
	L	H	D1(1)	D2(1)	Cable Diameter mm	Indicative Cable Section (2) mm ²
N11	200	50	8	26	8 - 25	4C x 1,5 ÷ 10
N12	260	67	16	32	16 - 31	4C x 10 ÷ 25
N13	360	75	21	38	21 - 36	4C x 35 ÷ 50
N14	400	100	26	41	26 - 39	4C x 50 ÷ 70
N15	530	130	35	56	35 - 54	4C x 95 ÷ 150
N16	700	150	47	74	45 - 72	4C x 185 ÷ 300

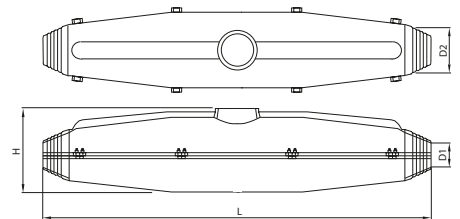

(1) Internal dimension of the shell
 (2) Indicative cable sections are approximate and concern only harmonised, PVC or Rubber insulated cables at a working voltage of 0,6/1 kV



BRANCH JOINTS

Type	Dimensions mm					Dimensions Cable		
	L	H	B	D1(1)	D2(1)	Cable Diameter mm	Indicative Cable Section (2) mm ²	
	Passante		Derivato					
NY00	150	47	70	11	20	11 - 20	4C x 1,5 ÷ 2,5	4C x 1,5
NY0	175	60	94	6	22	6 - 21	4C x 4 ÷ 10	4C x 4
NY1	225	75	110	9	26	9 - 24	4C x 6 ÷ 25	4C x 16

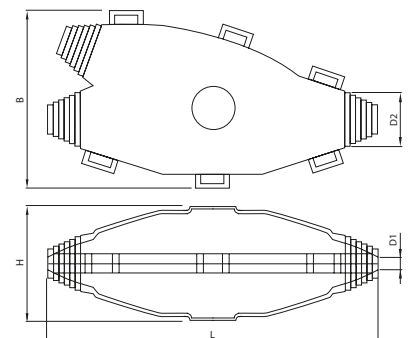

(1) Internal dimension of the shell
 (2) Indicative cable sections are approximate and concern only harmonised, PVC or Rubber insulated cables at a working voltage of 0,6/1 kV

Cast resin technology

PUR-cast resin technology was introduced to seal and protect power, signal and telephone cable joints.

This new generation of two component cast resin has been developed for the most demanding environments and circumstances.

Cembre cast resin joints meet the requirements of EN50393 and DIN VDE 57291-2 (VDE0291).

Quick setting properties in humid or even cold conditions make it a fast and reliable solution.

No external measuring or mixing is required as this takes place within an Aluminium foil pouch, avoiding spillage and errors during installation.

Unmixed resin components have a 48 month shelf-life even in the most difficult storage conditions.

Shells are made of durable PET resulting in good hydrophobic properties and excellent impact resistance, while good adhesion to PVC and metals assures a watertight seal.

Technical characteristic	Test result	Requirement of DIN VDE 0291
Pot life @ 5°C 23°C 35°C	35 min 20 min 15 min	product conforms ± 30%
Reactant open cup flash point	> 200 °C	> 55
Tensile strength	≥ 8.0 Mpa	≥ 5.0
Hot aging	-5 Shore A	-7
Adhesive	> 1500 CP.S	-
Elongation at break	≥ 100%	≥ 50%
Gel time for 300 ml @ Pouch >1000 ml Pouch <1000 ml	23 °C 26 min 17 min	product conforms ± 10% product conforms ± 10%
Max. reaction temp.	60 °C / 333 K	product conforms ± 10%
Total vol. variability when hardening	6 %	max. 6.5 %
Cast resin component open cup flash point	> 200 °C	> 100
Density	1.07 g / cm ³	-
Impact strength	> 10 kJ / m ²	> 10 kJ / m ²
Hardness	75 Shore A	min. 20 Shore D
Expansion coefficient in temp. range 20-50°C	5.9 x 10 ⁻⁴ K ⁻¹	product conforms ± 15%
Thermal conductivity	0.2W x m ⁻¹ x K ⁻¹	product conforms ± 20%
Flammability	Class II c	acc. to DIN VDE 0304, part 3
Water absorption 42 days@50°C	360 mg	max. 400 mg
Electrolytic corrosion	A1	-
Voltage test @ 23°C 80°C	> 20 kV > 10 kV	no breakdown @ test voltage > 20 kV > 20 kV
Dielectric dissipation factor @ 23°C and 50 Hz 23°C and 1k Hz	0.08 0.05	max. 0.1 -
Relative permittivity @ 23°C and 50 Hz @ 23°C and 1k Hz	5 5.1	< 6 -
Tracking resistance	KA 3c	min KA 3c
After 28 days of immersion in 90°C water		
Tensile strength	8.2N/mm ²	≥ 65% of initial value
Elongation at break	60%	≥ 65% of initial value
Hardness	47 Shore	≥ 80% of initial value

MECHANICAL TOOLS

MARKETline range

MARKETline

ML



TECHNICAL FEATURES

Crimping Range	For crimping insulated terminals, 0,25 to 6 sqmm side insertion
Dimensions mm	
Length	252
Width	78
Height	23
Weight g	556



MLL1



TECHNICAL FEATURES

Crimping Range	Single aperture, ratchet controlled tool for crimping female connectors, open barrel, flag type 1 to 2,5 sqmm - side insertion
Dimensions mm	
Length	252
Width	78
Height	23
Weight g	558



MLL90



TECHNICAL FEATURES

Crimping Range	For crimping end sleeves 0,25 to 6 sqmm
Dimensions mm	
Length	198
Width	77
Height	18
Weight g	350



MLS1



TECHNICAL FEATURES

Crimping Range	For crimping end sleeves 6 to 16 sqmm
Dimensions mm	
Length	198
Width	77
Height	18
Weight g	350



MLS2



TECHNICAL FEATURES

Crimping Range	For crimping insulated and uninsulated connectors, 0,25 to 6 sqmm
Dimensions mm	
Length	234
Width	65
Height	15
Weight g	228

ZP2

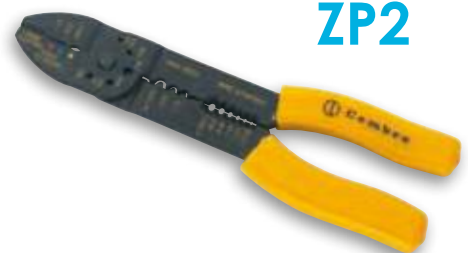

HB

MECHANICAL TOOLS

MARKETline range

TECHNICAL FEATURES

Application Range	Wire stripper, for PVC insulated cables 0,25 to 6 sqmm
Dimensions mm	
Length	166
Width	55
Height	15
Weight g	134



HB5

TECHNICAL FEATURES

Application Range	Wire stripper, for PVC insulated cables 0,2 to 6 sqmm
Dimensions mm	
Length	175
Width	90
Height	22
Weight g	200

MARKETline

HB8



TECHNICAL FEATURES

Application Range	A versatile tool for cutting, crimping, and stripping. Range: 0,2 to 6 sqmm
Dimensions mm	
Length	206
Width	106
Height	21
Weight g	256



HB7

CABLE TIE TOOLS

TECHNICAL FEATURES

Application Range	For plastic cable ties from 2,2 to 4,8 mm
Dimensions mm	
Length	162
Width	133
Height	23
Weight g	208



5313022048

Automatic cutting

TECHNICAL FEATURES

Application Range	For stainless steel cable ties width up to 7,9 mm
Dimensions mm	
Length	180
Width	141
Height	30
Weight g	558



5527030079

With cutting device

TECHNICAL FEATURES

Application Range	For plastic cable ties from 4,8 to 9 mm
Dimensions mm	
Length	194
Width	100
Height	25
Weight g	324



5523036090

Manual cutting

FLS

MEASURING TAPES

FLS3 3 metres long

FLS5 5 metres long

Robust metal case with comfortable ergonomic shape and protective mouldings for professional use. Nylon coated tape for long-life corrosion and abrasion resistance.

End hook magnet for increased user convenience.

Self-locking on extension, double release button for controlled retraction.

























































- FLS3 Weight : 166 g – Tape width : 16 mm

- FLS5 Weight : 252 g – Tape width : 19 mm

Supplied in individual blister or as a display of 12 units for FLS3 and FLS5





DIE SELECTOR CHART

APPLICATION	CONDUCTOR	CONNECTOR		HYDRAULIC TOOLS									
				B15MD		HT45-E B450ND-BV			HT51 RH50 B500 B500ND				
				DIE SET	NEST	INDEN-TOR	DIE SET	NEST	INDEN-TOR	DIE SET			
	Conductor Size sqmm Low Str. Flex	TERMINAL		SPLICE									
	0,25 ÷ 2,5	A 03-M.. A 06-M..		L 03-M / L 03-P L 06-M / L 06-P	ME03/2-15  MA03/3-15 								
	4 ÷ 6	A 1-M.. A 1-L..		L 1-M L 1-P	ME03/2-15  MA03/3-15 	MA1 	PA1	ME1 	MA1-50 	PA1-50	ME1-50 		
	10	A2-M.. A2-L.. A2-P12 A2-U..	A2-2M..	L 2-M L 2-P	ME03/2-15  ME2/3-15  MA03/3-15 			ME2 			ME2-50 		
	16	A3-M.. A3-L.. A3-P14 A3-P22R.. A3-U..	A3-2M.. 2A 3-M..	L 3-M L 3-P	ME2/3-15  MA03/3-15 	MA2.3 			MA2.3-50 			ME3-50 	
	25	A5-M.. A5-L.. A5-P16 A5-P22R..	A5-2M.. 2A 5-M..	L 5-M L 5-P		MA5 		ME5 	MA5-50 		ME5-50 		
	35	A 7-M.. A 7-L.. A 7-P20	A7-2M.. 2A 7-M..	L 7-M L 7-P		MA7 		ME7 	MA7-50 		ME7-50 		
	50	A 10-M.. A 10-L.. A 10-P25	A10-2M.. 2A 10-M.. 2A10-2M..	L 10-M L 10-P		MA10 		ME10 	MA10-50 	PA10-50	ME10-50 		
	70	A 14-M.. A 14-L.. A 14-P30	A14-2M.. 2A 14-M.. 2A14-2M..	L 14-M L 14-P				ME14 	MA14-50 		ME14-50 		
	95	A 19-M.. A 19-L..	A19-2M.. 2A 19-M.. 2A19-2M..	L 19-M L 19-P				ME19 	MA19-50 		ME19-50 		
	120	A 24-M.. A 24-L..	A24-2M.. 2A 24-M.. 2A24-2M..	L 24-M L 24-P				ME24 	MA24-50 	PA24-50	ME24-50 		
	150	A 30-M.. A 30-L..	A30-2M.. 2A 30-M.. 2A30-2M..	L 30-M L 30-P				ME30 			ME30-50 		
	185	A 37-M.. A 37-L.. A 37-4ESI	A37-2M.. 2A 37-M.. 2A37-2M..	L 37-M L 37-P							ME37-50 		
	240	A 48-M.. A 48-L.. A 48-4ESI	A48-2M.. 2A 48-M.. 2A48-2M..	L 48-M L 48-P							ME48-50 		
	300	A 60-M.. A 60-L.. A 60-4ESI	A60-2M.. 2A 60-M.. 2A60-2M..	L 60-M L 60-P							ME60-50** 		
	400	A 80-M.. A 80-4ESI	A80-2M.. 2A 80-M.. 2A80-2M..	L 80-M									
	500	A 100-M.. A 100-4ESI	A100-2M.. 2A 100-M.. 2A100-2M..	L 100-M									
	630	A 120-M.. A 120-4ESI	A120-2M.. 2A 120-M.. 2A120-2M..	L 120-M									
	800	A 160-M.. A 160-4ESI	A160-2M.. 2A 160-M.. 2A160-2M..	L 160-M									
	1000	A 200-M..		2A 200-M.. 2A200-2M..	L 200-M								
	35	A 9-M..				MA9	PA10	ME9	MA9-50	PA10-50	ME9-50		
	50	A 12-M..						ME12	MA12-50		ME12-50		
	70	A 17-M..						ME17	MA17-50	PA 19-50	ME17-50		
	95	A 20-M..						ME20	MA20-50		ME20-50		
	120	A 29-M..						ME29			ME29-50		
	150	A 35-M..									ME35-50		
	185	A 40-M..									ME40-50		

COPPER CONDUCTORS

EXTRA FLEXIBLE COPPER CONDUCTORS

 = Hexagonal crimp (use one size up with fine stranded conductors, E.G.: 95i fine stranded use A19-.. + ME 19 or A 20-.. + ME 20)

  = Indent crimp

* Contact Cembre for appropriate die set

DIE SELECTOR CHART

HYDRAULIC TOOLS											
HT 81-U RHU 81		HT 120 and tools and heads with 130 kN crimping force				ECW-H3D			RHU 520		
NEST AND INDENTOR	DIE SET	NEST	INDEN- TOR	DIE SET	NEST	INDENTOR	DIE SET	NEST	INDENTOR	DIE SET	
	MA3.5-U	ME2.19-U	MA2-C	PA10-C	ME2-C	Adaptor AU230-130-D with die set MA..-C and indentor PA..-C	Adaptor AU230-130-D with die set ME..-C	Adaptor AU520-130-C with die set MA..-C and indentor PA..-C		Adaptor AU 520-130 C with die set ME..-C	
	ME3.14-U	MA3-C	ME3-C								
	ME5.7-U	MA5-C	ME5-C								
MA7.14-U		MA7-C	ME7-C								
MA10.19-U	ME10.24-U	MA10-C		ME10-C							
MA7.14-U	ME3.14-U	MA14-C	PA24-C	ME14-C							
				ME17-C							
MA10.19-U	ME2.19-U	MA19-C		ME19-C							
MA24-U	ME10.24-U	MA24-C		ME24-C							
MA30.80-U	ME30-U	MA30-C	PA48-C	ME30-C							
MA37-U	ME37-U	MA37-C		ME37-C							
MA48-U	ME48-U	MA48-C		ME48-C							
		MA60-C	PA60-C	ME60-C							
				ME80-C	MA80-3D	PA100-3D	ME80-3D	MA80-520	PA120-520	ME80-520	
					MA100-3D		ME100-3D	MA100-520		ME100-520	
					MA120-3D		PA120-3D	ME120-3D		MA120-520	ME120-520
								MA160-520	PA200-520	ME160-520	
							MA200-520	ME200-520			
MA9.17-U	ME9.20-U	MA9-C	PA10-C	ME9-C	Adaptor AU 230-130 D with die set MA..-C and indentor PA..-C	Adaptor AU 230-130 D with die set ME..-C	Adaptor AU520-130-C with die set MA..-C and indentor PA..-C		Adaptor AU 520-130 C with die set ME..-C		
MA12.20-U	ME12.17-U	MA12-C	PA24-C	ME12-C							
MA9.17-U	ME12.17-U	MA17-C		ME17-C							
MA12.20-U	ME9.20-U	MA20-C		ME20-C							
MA29.80-U	ME29-U	MA29-C		ME29-C							
MA35-U	ME35-U	MA35-C	PA48-C	ME35-C							
MA40-U	ME40-U	MA40-C		ME40-C							

N.B.: Number inside symbol indicates the number of crimps on A-M barrel





** Only for B500, B500ND and RH50.

DIE SELECTOR CHART

APPLICATION	CONDUCTOR	CONNECTOR					
COPPER CONDUCTORS   	Conductor Size Flex sqmm	TERMINAL					
	10	ANE2-M..	ANE2-P12	ANE2-U..			
	16	ANE3-M..	ANE3-P14	ANE3-U..			
	25	ANE5-M..	ANE5-P16				
	35	ANE7-M..	ANE7-P20				
	50	ANE10-M..					
	70	ANE14-M..					
	95	ANE19-M..					
	120	ANE24-M..					
	150	ANE30-M..					
EXTRA FLEXIBLE COPPER CONDUCTORS 	35	ANE9-M..					
	50	ANE12-M..					
	70	ANE17-M..					
	95	ANE20-M..					
	120	ANE29-M..					
	150	ANE35-M..					
COPPER CONDUCTORS  	Conductor Size Flex sqmm	TERMINAL					
	0,3 ÷ 4	PKD506÷PKD418	PKE508÷PKE418	PKC508÷PKC418	KE506÷KE412		
	4 ÷ 16	PKD410÷PKD1618	PKE410÷PKE1618	PKC410÷PKC1618	KE410÷KE1616		
	16	PKD16..	PKE16..	PKC16..	KE16..		
	25	PKD25..	PKE25..	PKC25..	KE25..		
	35	PKD35..		PKC35..	KE35..		
	50	PKD50..		PKC50..			
	70			PKC70..			
	95			PKC95..			
	120			PKC120..			
COPPER CONDUCTORS 	Conductor Size Flex sqmm	TERMINAL					
	2 x 0,5	PKT508 PKT510					
	2 x 0,75	PKT7508 PKT7510					
	2 x 1	PKT108 PKT110					
	2 x 1,5	PKT1508 PKT1512					
	2 x 2,5	PKT2510 PKT2512					
	2 x 4	PKT412					
	2 x 6	PKT614					
	2 x 10	PKT1014					
	2 x 16	PKT1614					

 = Indent crimp
  = Radial crimp
  = Trapezium crimp

DIE SELECTOR CHART

APPLICATION	CONDUCTOR		CONNECTOR				HYDRAULIC TOOLS					ECW-H3D	RHU520
	Conductor Size sqmm		CONNECTOR	CONNECTOR	CONNECTOR	HT51 RH50 B500E	HT81-U RHU 81	HT 120 and tools and heads with 130 kN crimping force		DIE SET	DIE SET		
	Run	Tap	CONNECTOR	CONNECTOR	CONNECTOR	DIE SET	DIE SET	DIE SET	DIE SET				
TAP-OFF ON COPPER CONDUCTOR  	6 ÷ 2,5	6 ÷ 1,5	C6-C6ST	C6-C6		MC6-50	MC6-25-U						
	10	10 ÷ 1,5	C10-C10ST	C10-C10		MC10-50	MC10-U	MC10-C					
	16	16 ÷ 1,5	C16-C16ST	C16-C16									
	25 ÷ 16	10 ÷ 1,5	C25-C10ST	C25-C10									
	25	25 ÷ 16	C25-C25ST	C25-C25		MC25-50	MC6-25-U MC25-U	MC25-C				Adaptor AU230-130-D with die set MRH.-C	
	40 ÷ 35	16 ÷ 1,5	C35-C16ST	C35-C16									
	40 ÷ 35	40 ÷ 25	C35-C35ST	C35-C35									
	50	25 ÷ 10				MC35	MC35-U	MC35-C					
	70 ÷ 63	25 ÷ 1,5	C70-C25NST	C70-C25N									
	50	25 ÷ 4	C50-C25ST	C50-C25									
	*50	50 ÷ 35	C50-C50ST	C50-C50									
	*70 ÷ 50	40 ÷ 4	C70-C35ST	C70-C35		*MC70-50	MC70-80-U	MC70-C				Adaptor AU520-130-C with die set MC.-C	
	*70 ÷ 50	70 ÷ 35	C70-C70ST	C70-C70									
	100 ÷ 95	40 ÷ 4	C95-C35ST	C95-C35									
	100 ÷ 95	70 ÷ 40	C95-C70ST	C95-C70									
	100 ÷ 95	100 ÷ 63	C95-C95ST	C95-C95									
	125 ÷ 110	125 ÷ 25	C120-C120ST	C120-C120									
	160 ÷ 150	125 ÷ 25	C150-C120ST	C150-C120									
	125	125											
	150	150 ÷ 63	C150-C150ST	C150-C150									
125	125												
185	100 ÷ 16	C185-C95ST	C185-C95										
185 ÷ 120	185 ÷ 120	C185-C185ST	C185-C185										
240 ÷ 150	120 ÷ 95	C240-C120ST	C240-C120										
COPPER CONDUCTORS  	Conductor Size sqmm		CONNECTOR	CONNECTOR	CONNECTOR								
	Run	Tap											
	70	70	H70-H70	H70-H70ST									
	95	95	H95-H95	H95-H95ST									
	120	120	H120-H120	H120-H120ST									
	Cond. Size sqmm		CONNECTOR	CONNECTOR	CONNECTOR								
	2 x 50		DK50-M12										
2 x 70		DK70-M12	DK70-2M12-51AS										
2 x 95		DK95-M12	DK95-2M12-51AS										
2 x 120		DK120-M12	DK120-2M12-51AS										

 = Hexagonal crimp
  = oval crimp
  = circular crimp
 * When using die set type MC70-50, the conductors marked with a star must be annealed.

DIE SELECTOR CHART

APPLICATION	CONDUCTOR		CONNECTOR		HYDRAULIC TOOLS					
	CONDUCTOR		CONNECTOR		HT45-E B450ND-BVE	HT51 RH50 B500NDE	HT 81-U RHU 81	HT 120 and tools and heads with 130 kN crimping force		RHU520
	Cond. Size sqmm	TERMINAL	TERMINAL	TERMINAL	DIESET	DIESET	DIESET	DIESET	DIESET	DIE SET
 MT.-TD MT.-GC CA.-M. CA.-2M. MT.-C.	25 R	MT25-ID	MT25-GC	CA25-ML. CA25-2M.	MT25-C.	MMT25-50	MMT25-U	MMT25-C		
	35 RC/Δ ÷ 40 S	MT40S-TD	MT40S-GC	CA40S-ML. CA40S-2M.	MT40S-C.	MMT50-50	MMT50-U	MMT50-C		
	50 RC	MT50R-TD	MT50R-GC	CA50R-ML. CA50R-2M.	MT50R-C.	MMT200-50	MMT200-U	MMT200-C		
	50 S	MT50S-TD	MT50S-GC	CA50S-ML. CA50S-2M.	MT50S-C.					
	63 S ÷ 70 S	MT70S-TD	MT70S-GC	CA70S-ML. CA70S-2M.	MT70S-C.					
	80 S ÷ 95 RC	MT95R-TD	MT95R-GC	CA95R-ML. CA95R-2M.	MT95R-C.					
	95 S ÷ 100 S	MT95S-TD	MT95S-GC	CA95S-ML. CA95S-2M.	MT95S-C.					
	120 RC/S ÷ 150 RC	MT150R-TD	MT150R-GC	CA150R-ML. CA150R-2M.	MT150R-C.					
	150 S ÷ 160 RC	MT150S-TD	MT150S-GC	CA150S-ML. CA150S-2M.	MT150S-C.					
	160 S ÷ 200 RC	MT200R-TD	MT200R-GC	CA200R-ML. CA200R-2M.	MT200R-C.					
185 BR/BS	MT185-TD	MT185-GC	CA185-ML. CA185-2M.	MT185-C.						
200 S ÷ 240 RC	MT240R-TD	MT240R-GC	CA240R-ML. CA240R-2M.	MT240R-C.						
240 S ÷ 315 RC	MT315R-TD	MT315R-GC	CA315R-ML. CA315R-2M.	MT315R-C.						
315 S	MT315S-TD	MT315S-GC	CA315S-ML. CA315S-2M.	MT315S-C.						
400 R	MT400-TD		2A80-ML. 2A80-2M.						ME80-520	
500 R	MT500-TD		2A100-ML. 2A100-2M.						ME100-520	
600 R ÷ 630 R	MT630-TD		2A120-ML. 2A120-2M.						ME120-520	

DIE SELECTOR CHART FOR DEEP STEPPED INDENTING WITH CONTAINING DIES

APPLICATION	CONDUCTOR	CONNECTOR		HYDRAULIC TOOLS					
		CONNECTOR		DIE HOLDER	HT 131-UC RHU 131-C		B1350-UCE B1300-UCE		INDENTOR
		Conductor Size sqmm	LUGS	DIE HOLDER	DIE	DIE	DIE	INDENTOR	
 CAA.-M. MTA.-C AA.-M.	10	CAA10-M.		AU130-150	MV85	MUA35	PS130-35/E		
	16	CAA16-M.	MTA16-C						
	25	CAA25-M.	MTA25-C						
	35	CAA35-M.	MTA35-C						
	50	CAA50-M.	MTA50-C						
	70	CAA70-M.	MTA70-C						
	95	CAA95-M.	MTA95-C						
	120	CAA120-M.	MTA120-C						
	150	CAA150-M.	MTA150-C						
	185	CAA185-M.	MTA185-C						
240	CAA240-M.	MTA240-C	AU130-240	MV240	MUA240	PS130-240/E			
300	CAA300-34M.			MUA300-34					
16	AA16-M.								
25	AA25-M.								
35	AA35-M.								
50	AA50-M.								
70	AA70-M.								
95	AA95-M.								
120	AA120-M.								
150	AA150-M.								
185	AA185-M.								
240	AA240-M.								
300	AA300-34M.								

 = Deep indent crimp
  = Hexagonal crimp
  = circular crimp

DIE SELECTOR CHART FOR DEEP STEPPED INDENTING WITH CONTAINING DIES

ALUMINIUM CONDUCTORS	Conductor Size sqmm		SPLICE		Conductor Size sqmm		SPICES		DIE HOLDER		DIE		INDENTOR	
	Al	Al/Cu	MTMA10-GC	MTMA16/1	MTMA16-GC	MTMA16	MTMA16-10GC	MVMA35	MUA35	MVMA35	MUA35	PS130-35/E		
	10		MTMA10-GC	MTMA16/1	MTMA16-GC	MTMA16	MTMA16-10GC							
	16		MTMA16-GC	MTMA25/1	MTMA25-GC	MTMA25	MTMA25-10GC							
	25		MTMA25-GC	MTMA35/1	MTMA35-GC	MTMA35	MTMA35-16GC							
	35		MTMA35-GC	MTMA50/1	MTMA50-GC	MTMA50	MTMA50-25GC							
	50		MTMA50-GC	MTMA70/1	MTMA70-GC	MTMA70	MTMA70-35GC							
	70		MTMA70-GC	MTMA95/1	MTMA95-GC	MTMA95	MTMA95-50GC							
	95		MTMA95-GC	MTMA120/1	MTMA120-GC	MTMA120	MTMA120-70GC							
	120		MTMA120-GC	MTMA150/1	MTMA150-GC	MTMA150	MTMA150-95GC							
	150		MTMA150-GC	MTMA185/1	MTMA185-GC	MTMA185	MTMA185-120GC							
	185		MTMA185-GC	MTMA240/1	MTMA240-GC	MTMA240	MTMA240-150GC							
	240		MTMA240-GC	MTMAD300/1	MTMAD300-GC	MTMAD300	MTMAD300-185GC							
	300		MTMAD300-GC				MTMAD300-185GC							
							MTMAD300-240GC							





MTMA...GC

ALUMINIUM CONDUCTORS

= Deep indent crimp

PRE-ROUNDERS SELECTION		DIE-SUPPORT		DIES DESCRIPTION		DIES SEQUENCE	
ALUMINIUM CONDUCTOR SIZE sqmm	PRE-ROUNDER	DIE-SUPPORT	1) AU 130... DIE-HOLDER	2) UP 130... PRE-ROUNDERS	CONDUCTOR ROUNDING	CRIMPING	
25			Used to house dies and pre-rounders.	Used to round aluminium sectoral conductors in order to introduce them into circular connectors. Each pre-rounder is made of two parts: the upper part is housed in die-holder AU 130..., and the lower part is locked onto AC 130-P... die support.			
35							
50							
70							
95							
120							
150							
185							
240							

DIE SELECTOR CHART

APPLICATION	CONDUCTOR	CONNECTOR		BT5MD	HT45-E B450ND-BV	HT51 B500	HT60C B600C	HT81-U RHU81	HT 120 and tools and heads with 130 kN crimping force			ECW-HSD	RHU520	
		LUGS	SPLICES						INDENTOR	NEST	INDENTOR			NEST
 Q. DIN 46234	6-10	Q10..											Adaptor AU520-130-C with die set MQ...	
	10-16	Q16..												
	16-25	Q25..												
	25-35	Q35..												
	35-50	Q50..												
	50-70	Q70..												
	70-95	Q95..												
	95-120	Q120..												
	120-150	Q150..												
	150-185	Q185..												
	185-240	Q240..												
	6	DR6..	DSV6											
	10	DR10..	DSV10	MKS18-15	MK5	MK5-50	MK5-60C	MK5-50	MK5-50	MK5-C				
	16	DR16..	DSV16		MK6	MK6-50	MK6-60C	MK6-50	MK6-50	MK6-C				
	25	DR25..	DSV25		MK8	MK8-50	MK8-60C	MK8-50	MK8-50	MK8-C				
	35	DR35..	DSV35		MK10	MK10-50	MK10-60C	MK10-50	MK10-50	MK10-C				
	50	DR50..	DSV50		MK12	MK12-50	MK12-60C	MK12-50	MK12-50	MK12-C				
	70	DR70..	DSV70		MK14	MK14-50	MK14-60C	MK14-50	MK14-50	MK14-C				
95	DR95..	DSV95		MK16	MK16-50	MK16-60C	MK16-50	MK16-50	MK16-C					
120	DR120..	DSV120		MK18	MK18-50	MK18-60C	MK18-50	MK18-50	MK18-C					
150	DR150..	DSV150		MK20	MK20-50	MK20-60C	MK20-50	MK20-50	MK20-C					
185	DR185..	DSV185		MK22L	MK22-50	MK22-60C	MK22-50	MK22-50	MK22-C					
240	DR240..	DSV240			MK25-50	MK25-60C	MK25-50	MK25-50	MK25-C					
300	DR300..	DSV300			MK28-50	MK28-60C	MK28-50	MK28-50	MK28-C					
400	DR400..	DSV400			MK32-50*	MK32-60C	MK32-50	MK32-50	MK32-C					
500	DR500..	DSV500												
625	DR625..	DSV625												
800	DR800..	DSV800												
1000	DR1000..	DSV1000												
 HR.. COPPER CONDUCTORS	6	HR6..	HSV6										Adaptor AU520-130-C with die set MH...-C	
	10	HR10..	HSV10	MH10/16/15	MH6-50	MH6-60C	MH6-50	MH6-50	MH6-C					
	16	HR16..	HSV16		MH10-50	MH10-60C	MH10-50	MH10-50	MH10-C					
	25	HR25..	HSV25		MH16-50	MH16-60C	MH16-50	MH16-50	MH16-C					
	35	HR35..	HSV35		MH25-50	MH25-60C	MH25-50	MH25-50	MH25-C					
	50	HR50..	HSV50		MH35-50	MH35-60C	MH35-50	MH35-50	MH35-C					
	70	HR70..	HSV70		MH50-50	MH50-60C	MH50-50	MH50-50	MH50-C					
	95	HR95..	HSV95		MH70-50	MH70-60C	MH70-50	MH70-50	MH70-C					
	120	HR120..	HSV120		MH95-50	MH95-60C	MH95-50	MH95-50	MH95-C					
	150	HR150..	HSV150		MH120-50	MH120-60C	MH120-50	MH120-50	MH120-C					
	185	HR185..	HSV185		MH150-50	MH150-60C	MH150-50	MH150-50	MH150-C					
	240	HR240..	HSV240		MH185-50	MH185-60C	MH185-50	MH185-50	MH185-C					
300	HR300..	HSV300		MH240-50	MH240-60C	MH240-50	MH240-50	MH240-C						
400	HR400..	HSV400		MH300-50*	MH300-60C	MH300-50	MH300-50	MH300-C						
500	HR500..	HSV500												
630	HR630..	HSV630												

Tools type HT 81-U and RHU 81 with adaptor type 6780232 can use the same dies of HT 51 but are equipped with spring type 6522051

* Only for B500, B500ND and RH50

Hexagonal crimp = Indent crimp

NB: for through connectors this is the number of crimps per conductor

DIE SELECTOR CHART

APPLICATION	CONDUCTOR		CONNECTOR		HYDRAULIC TOOLS					
	Conductor Size sqmm	Conductor Size AWG	LUGS	SPLICE	HT 120 and tools and heads with 130 kN crimping force					
					B15MD	HT51 B500	RH50 B500ND	ECW-H3D	RHU520	
C...	10	8	C8..	BSCL8	ME03/2-15			MY2-50	MY2-C	
					ME2/3-15					
CL...	16	6	C6..	BSCL6	MA03/3-15			MY3-50	MY3-C	
					ME2/3-15					
CL...	25	4	C4..	BSCL4			MY4-50	MY4-C		
							MY5-50	MY5-C		
CL...	35	2	C2..	BSCL2			MY6-50	MY6-C		
							MY7-50	MY7-C		
CL...	50	1/0	C1/0.	BSCL1/0			MY10-50	MY10-C		Adaptor AU520-130-C with die set MY.-C
							MY14-50	MY14-C		
CL...	70	2/0	C2/0.	BSCL2/0			MY16-50	MY16-C		Adaptor AU230-130-D with die set MY.-C
							MY19-50	MY19-C		
CL...	95	3/0	C3/0.	BSCL3/0			MY24-50	MY24-C		
							MY30-50	MY30-C		
BSCL	120	250 MCM	C4/0.	BSCL4/0			MY36-50	MY36-C		
							MY37-50	MY37-C		
BSCL	150	300 MCM	C250..	BSCL250			MY48-50	MY48-C		
BSCL	185	350 MCM	C300..	BSCL300						
BSCL	240	400 MCM	C350..	BSCL350						
BSCL	300	500 MCM	C400..	BSCL400						
BSCL	300	600 MCM	C500..	BSCL500						
BSCL	300	750 MCM	C600..	BSCL600						
BSCL	300	750 MCM	C750..	BSCL750						



N.B.: Number inside symbol indicates the number of crimps for C short barrel lugs only.

○ = Circular crimp ◐ = Indent crimp ◑ = Hexagonal crimp

COPPER CONDUCTORS



DIE SELECTOR CHART

APPLICATION	CONDUCTOR	CONNECTOR		HYDRAULIC TOOLS				HYDRAULIC TOOLS				HYDRAULIC TOOLS																															
		TERMINAL	SPLICE	B15MD	HT45-E B450ND-BV	HT51 RH50 B500 B500ND	HT81-U RHU81	HT120 and tools and heads with 130 kN crimping force	ECW-H3D	RHU520	CONDUCTOR SIZE	TERMINAL	SPLICE	B15MD	HT45-E B450ND-BV	HT51 RH50 B500 B500ND	HT81-U RHU81	HT120 and tools and heads with 130 kN crimping force	ECW-H3D	RHU520																							
  	4÷6	T6-M. T6-L.	L6-T.	MS4/10-15	MA1	PA1	MS6	MA1-50	PA1-50	MS6-50	MS6-10-U	MA2-C	MA2-C	MS6-C	MS6-10-U	MA2-C	MA2-C	MS10-C	MS10-C	MS16-C	MS16-C	MS25-C	MS25-C	MS35-C	MS35-C	MS50-C	MS50-C	MS70-C	MS70-C	MS95-C	MS95-C	MS120-C	MS120-C	MS150-C	MS150-C	MS185-C	MS185-C	MS240-C	MS240-C	MS300-C	MS300-C	MS400-C	MS400-C
	10	T10-M. T10-L.	L10-T.	MS4/10-15 MS10/16-15	MA2.3	PA5	MS10	MA2.3-50	PA5-50	MS10-50	MS16-10-U	MA3-C	MA3-C	MS16-C	MS16-25-U	MA3-C	MA3-C	MS16-C	MS16-25-U	MA3-5-U	MA3-5-U	MS16-25-U	MS16-25-U	MS35-50-U	MS35-50-U	MS50-50-U	MS50-50-U	MS70-150-U	MS70-150-U	MS95-120-U	MS95-120-U	MS120-50	MS120-50	MS150-50	MS150-50	MS185-50	MS185-50	MS240-50	MS240-50	MS300-50*	MS300-50*	MS400-50	MS400-50
	16	T16-M. T16-L.	L16-T.	MS10/16-15	MA5	PA10	MS25	MA5-50	PA10-50	MS25-50	MS35-50-U	MA7-C	MA7-C	MS35-50	MS35-50-U	MA7-14-U	MA7-14-U	MS35-50	MS35-50-U	MA10-19-U	MA10-19-U	MS35-50-U	MS35-50-U	MS50-50	MS50-50	MS70-150-U	MS70-150-U	MS95-120-U	MS95-120-U	MS120-50	MS120-50	MS150-50	MS150-50	MS185-50	MS185-50	MS240-50	MS240-50	MS300-50*	MS300-50*	MS400-50	MS400-50		
	25	T25-M. T25-L.	L25-T.		MA7	PA10	MS35	MA7-50	PA10-50	MS35-50	MS50-50-U	MA10-C	MA10-C	MS50-50	MS50-50	MA10-19-U	MA10-19-U	MS50-50	MS50-50	MA10-19-U	MA10-19-U	MS50-50	MS50-50	MS70-150-U	MS70-150-U	MS95-120-U	MS95-120-U	MS120-50	MS120-50	MS150-50	MS150-50	MS185-50	MS185-50	MS240-50	MS240-50	MS300-50*	MS300-50*	MS400-50	MS400-50				
	35	T35-M. T35-L.	L35-T.		MA10	PA10	MS50	MA10-50	PA10-50	MS50-50	MS70-150-U	MA14-C	MA14-C	MS70-50	MS70-50	MA19-17-U	MA19-17-U	MS70-150-U	MS70-150-U	MA19-17-U	MA19-17-U	MS70-150-U	MS70-150-U	MS95-120-U	MS95-120-U	MS120-50	MS120-50	MS150-50	MS150-50	MS185-50	MS185-50	MS240-50	MS240-50	MS300-50*	MS300-50*	MS400-50	MS400-50						
	50	T50-M. T50-L.	L50-T.				MS70	MA14-50	PA19-50	MS70-50	MS95-50	MA19-C	MA19-C	MS95-50	MS95-50	MA24-24-U	MA24-24-U	MS95-50	MS95-50	MA24-24-U	MA24-24-U	MS95-50	MS95-50	MS120-50	MS120-50	MS150-50	MS150-50	MS185-50	MS185-50	MS240-50	MS240-50	MS300-50*	MS300-50*	MS400-50	MS400-50								
	70	T70-M. T70-L.	L70-T.				MS95	MA19-50	PA24-50	MS95-50	MS120-50	MA30-C	MA30-C	MS120-50	MS120-50	MA37-C	MA37-C	MS120-50	MS120-50	MA37-C	MA37-C	MS120-50	MS120-50	MS150-50	MS150-50	MS185-50	MS185-50	MS240-50	MS240-50	MS300-50*	MS300-50*	MS400-50	MS400-50										
	95	T95-M. T95-L.	L95-T.				MS120	MA24-50	PA24-50	MS120-50	MS150-50	MA48-C	MA48-C	MS150-50	MS150-50	MA48-U	MA48-U	MS150-50	MS150-50	MA48-U	MA48-U	MS150-50	MS150-50	MS185-50	MS185-50	MS240-50	MS240-50	MS300-50*	MS300-50*	MS400-50	MS400-50												
	120	T120-M. T120-L.	L120-T.				MS150	MA30-50	PA24-50	MS150-50	MS185-50	MA60-C	MA60-C	MS185-50	MS185-50	MA60-C	MA60-C	MS185-50	MS185-50	MA60-C	MA60-C	MS185-50	MS185-50	MS240-50	MS240-50	MS300-50*	MS300-50*	MS400-50	MS400-50														
	150	T150-M. T150-L.	L150-T.							MS185-50	MS240-50	MA60-C	MA60-C	MS240-50	MS240-50	MA60-C	MA60-C	MS240-50	MS240-50	MA60-C	MA60-C	MS240-50	MS240-50	MS300-50*	MS300-50*	MS400-50	MS400-50																
	185	T185-M. T185-L.	L185-T.																																								
	240	T240-M. T240-L.	L240-T.																																								
	300	T300-M. T300-L.	L300-T.																																								
	400	T400-M. T400-L.	L400-T.																																								

* Only for B500, B500ND and RH50

⬡ = Hexagonal crimp

⬢ = Indent crimp

DIE SELECTOR CHART

APPLICATION	Conductor Size sqmm		MATERIAL (Al)		HYDRAULIC TOOLS							RHU450	RHU520		
	rm/sm	re/se	LUGS	SPLICES	HT45-E B450ND-BV	HT51 RH50 B500	HT60C RH60C B600CND	HT81-U RHU81	HT120 and tools and heads with 130 kN crimping force	ECW-H3D	DIESET	DIESET	DIESET		
AAD.	10	16					MK10B-60C								
	16	25	AAD16-M..	DSVA16	MK12B	MK12B-50	MK12B-60C	MK12B-50	MK12-C						
	25	35	AAD25-M..	DSVA25	MK12B	MK12B-50	MK12B-60C	MK12B-50	MK12-C						
	35	50	AAD35-M..	DSVA35	MK14B	MK14B-50	MK14B-60C	MK14B-50	MK14-C						
	50	70	AAD50-M..	DSVA50	MK16B	MK16B-50	MK16B-60C	MK16B-50	MK16-C						
	70	95	AAD70-M..	DSVA70	MK18B	MK18B-50	MK18B-60C	MK18B-50	MK18-C						
	95	120	AAD95-M..	DSVA95	MK22B	MK22B-50	MK22B-60C	MK22B-50	MK22-C						
	120	150	AAD120-M..	DSVA120	MK22B	MK22B-50	MK22B-60C	MK22B-50	MK22-C						
	150	185	AAD150-M..	DSVA150		MK25B-50	MK25B-60C	MK25B-50	MK25-C						
	185	240	AAD185-M..	DSVA185		MK28B-50	MK28B-60C	MK28B-50	MK28L-C						
DSVA.	240	300	AAD240-M..	DSVA240		MK32B-50	MK32B-60C	MK32L-C							
	300		AAD300-M..	DSVA300			MK34B-60C	MK34L-C							
	400		AAD400-M..	DSVA400 / DSVA401						MK38-3D	MK38-450	MK38-520			
	500		AAD500-M..	DSVA500 / DSVA501						MK44-3D	MK44-450	MK44-520			
	625			DSVA625							MK52-450	MK52-520			
	800			DSVA800							MK58-450	MK58-520			
	1000			DSVA1000							MK60-450	MK60-520			



AAD.



DSVA.

DIN EN 50182





















rm = round stranded
 sm = sector stranded
 re = round solid
 se = sector solid

⬡ = Hexagonal crimp

NB: for through connectors this is the number of crimps per conductor

⬢ Tools type HT 81-U and RHU 81 with adaptor type 6780232 can use the same dies of HT 51 but are equipped with spring type 6522051

MUT DIES CROSS REFERENCE CHART

DIE INDEX	DIETYPE			
	 14.6 tons tools 131 series	 6 tons tools 51 series	 6 tons tools 45 series	 6 & 6.4 tons tools 54 & 55 series
161	MUT9999-C	MUT9999-50	MUT9999	MUT9999-W
162	MUT9998-C	MUT9998-50	MUT9998	MUT9998-W
163	MUT9997-C	MUT9997-50	MUT9997	MUT9997-W
164	MUT9996-C	MUT9996-50	MUT9996	MUT9996-W
166	MUT9995-C	MUT9995-50	MUT9995	MUT9995-W
167	MUT9958-C	-	-	MUT9958-W
168	MUT9974-C	-	-	-
169	MUT9979-C	-	-	-
170	MUT9973-C	-	-	-
203	MUT9943-C	MUT9943-50	-	MUT9943-W
204	MUT9941-C	MUT9941-50	-	MUT9941-W
209	MUT9972-C	-	-	-
239	MUT9993-C	MUT9993-50	MUT9993	MUT9993-W
242	MUT9967-C	-	-	-
243	MUT9991-C	MUT9991-50	MUT9991	MUT9991-W
247	-	MUT9954-50	-	MUT9954-W
249	MUT9990-C	MUT9990-50	MUT9990	MUT9990-W
253	MUT9957-C	-	-	-
255	MUT9962-C	-	-	-
261	MUT9956-C	-	-	-
296*	 beige	MUT9924-C	-	-
297*	 yellow olive	MUT9923-C	-	-
298*	 white	MUT9921-C	-	-
299*	 brown	MUT9918-C	-	-
300*	 pink	MUT9916-C	-	-
305	MUT9977-C	-	-	-
316	MUT9976-C	-	-	-
317	MUT9965-C	-	-	-
322	MUT9971-C	-	-	-
324*	 red	MUT9920-C	-	-
327	MUT9961-C	-	-	-
346*	 grey	MUT9928-C	-	-
348*	 pink	MUT9926-C	-	-
373	MUT9989-C	MUT9989-50	-	MUT9989-W
374*	 blue	MUT9929-C	-	-
375*	 green	MUT9927-C	-	-
467*	 rubin	MUT9922-C	-	-
470*	 blue	MUT9919-C	-	-
471*	 gold	MUT9925-C	-	-
472*	 green	MUT9917-C	-	-
473*	 black	MUT9915-C	-	-
490	MUT9966-C	-	-	-
642	MUT9970-C	-	-	-
654	MUT9975-C	MUT9975-50	-	-
655	MUT9968-C	-	-	-
658	MUT9988-C	MUT9988-50	-	MUT9988-W
659	MUT9987-C	MUT9987-50	MUT9987	MUT9987-W
936*	 yellow	MUT9914-C	-	-
698	MUT9986-C	MUT9986-50	MUT9986	MUT9986-W
699	MUT9985-C	MUT9985-50	-	MUT9985-W
708	MUT9959-C	-	-	-
756	MUT9964-C	-	-	-
788	MUT9950-C	-	-	-
790	MUT9969-C	-	-	-
BG	MUT9984-C	MUT9984-50	-	MUT9984-W
C	MUT9983-C	MUT9983-50	MUT9983	MUT9983-W
D	MUT9978-C	-	-	-
D3	MUT9981-C	MUT9981-50	-	-
E	MUT9982-C	MUT9982-50	-	MUT9982-W
F	MUT9960-C	-	-	-
K840	-	-	-	MUT9942-W
N	MUT9955-C	-	-	-
O	MUT9980-C	MUT9980-50	-	MUT9980-W

*Stainless steel dies

RHU600 DIES CROSS REFERENCE CHART

DIE INDEX	DIE TYPE			
	CEMBRE	ALCOA	HUSKIE	BURNDY
10SH	M10SH-600	6010SH	HA60-01	-
12SH	M12SH-600	6012SH	HA60-02	-
14SH	M14SH-600	6014SH	HA60-03	-
16SH	M16SH-600	6016SH	HA60-04	-
18SH	M18SH-600	6018SH	HA60-05	-
20SH	M20SH-600	6020SH	HA60-06	-
74SH	M74SH-600	6074SH	HA60-07	-
75SH	M75SH-600	6075SH	HA60-08	-
76SH	M76SH-600	6076SH	HA60-09	-
76.1SH	M76.1SH-600	6076.1SH	-	-
20AH	M20AH-600	6020AH	HA60-20	20AH60
24AH	M24AH-600	6024AH	HA60-21	24AH60
27AH	M27AH-600	6027AH	HA60-22	27AH60
30AH	M30AH-600	6030AH	HA60-23	30AH60
34AH	M34AH-600	6034AH	HA60-24	34AH60
36AH	M36AH-600	6036AH	HA60-25	36AH60
38AH	M38AH-600	6038AH	HA60-26	38AH60
40AH	M40AH-600	6040AH	HA60-27	40AH60
74AH	M74AH-600	6074AH	HA60-28	-
75AH	M75AH-600	6075AH	HA60-29	75AH60
76AH	M76AH-600	6076AH	HA60-30	76AH60
07CD	M7CD-600	6007CD	HA60-40	07CD60
08CD	M8CD-600	6008CD	HA60-41	08CD60
09CD	M9CD-600	6009CD	HA60-42	09CD60
10CD	M10CD-600	6010CD	HA60-43	10CD60
11CD	M11CD-600	6011CD	HA60-44	11CD60
12CD	M12CD-600	6012CD	HA60-45	12CD60
13CD	M13CD-600	6013CD	HA60-46	13CD60
14CD	M14CD-600	6014CD	HA60-47	14CD60
15CD	M15CD-600	6015CD	HA60-48	15CD60
16CD	M16CD-600	6016CD	HA60-49	16CD60
17CD	M17CD-600	6017CD	HA60-50	17CD60

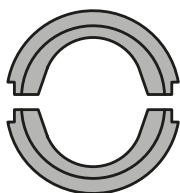
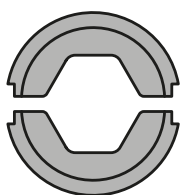

RHU1000 DIES CROSS REFERENCE CHART

DIE INDEX	DIETYPE		
	 CEMBRE	ALCOA	HUSKIE
10SH	M10SH-1000	10010SH	HA100-01
12SH	M12SH-1000	10012SH	HA100-02
14SH	M14SH-1000	10014SH	HA100-03
16SH	M16SH-1000	10016SH	HA100-04
18SH	M18SH-1000	10018SH	HA100-05
20SH	M20SH-1000	10020SH	HA100-06
76SH	M76SH-1000	10076SH	-
20AH	M20AH-1000	10020AH	HA100-20
24AH	M24AH-1000	10024AH	HA100-21
27AH	M27AH-1000	10027AH	HA100-22
30AH	M30AH-1000	10030AH	HA100-23
34AH	M34AH-1000	10034AH	HA100-24
36AH	M36AH-1000	10036AH	HA100-25
38AH	M38AH-1000	10038AH	HA100-26
40AH	M40AH-1000	10040AH	HA100-27
76AH	M76AH-1000	10076AH	HA100-30
42AH	M42AH-1000	10042AH	HA100-34
44AH	M44AH-1000	10044AH	HA100-36
48AH	M48AH-1000	10048AH	HA100-38
07CD	M7CD-1000	10007CD	HA100-40
08CD	M8CD-1000	10008CD	HA100-41
09CD	M9CD-1000	10009CD	HA100-42
10CD	M10CD-1000	10010CD	HA100-43
11CD	M11CD-1000	10011CD	HA100-44
12CD	M12CD-1000	10012CD	HA100-45
13CD	M13CD-1000	10013CD	HA100-46
14CD	M14CD-1000	10014CD	HA100-47
15CD	M15CD-1000	10015CD	HA100-48
16CD	M16CD-1000	10016CD	HA100-49
17CD	M17CD-1000	10017CD	HA100-50
18CD	M18CD-1000	10018CD	HA100-51
19CD	M19CD-1000	10019CD	HA100-52
20CD	M20CD-1000	10020CD	HA100-53

APPENDIX



Type/Code Cross-Reference chart

Type	Code	Type	Code	Type	Code	Type	Code	Type	Code
1112	3005715	1892	3016440	1142048	3005055	1053M40	3005973	1153M3216	3018874
1116	3005720	1893	3016460	2021012	3014120	1053M40N	3005974	1153M3220	3018876
1120	3005725	1894	3016480	2021014	3014110	1053M50	3005976	1153M3225	3018878
1125	3005730	1895	3016490	2021034	3014130	1053M50N	3005977	1153M3225N	3018879
1132	3005735	1896	3016500	2021038	3014115	1053M63	3005979	1153M4020	3018882
1140	3005740	1897	3016510	2021058	3014125	1053M63N	3005980	1153M4025	3018884
1150	3005745	1898	3016520	2021100	3014135	1112N	3005716	1153M4032	3018886
1163	3005750	1899	3016530	2021112	3014155	1116N	3005721	1153M5025	3018890
1400	3003110	2155	3051010	2021114	3014145	1120N	3005726	1153M5032	3018892
1401	3003114	2156	3051015	2021118	3014140	1125N	3005731	1153M5040	3018894
1402	3003120	2157	3051020	2021200	3014170	1132N	3005736	1153M6332	3018898
1403	3003125	2158	3051125	3411012	3016645	1140N	3005741	1153M6340	3018900
1404	3003130	2160	3051130	3411014	3016615	1141012N	3005121	1153M6350	3018902
1405	3003135	2161	3051135	3411034	3016665	1141112N	3005156	1163N	3005751
1407	3003155	2162	3051140	3411038	3016625	1141200N	3005171	1173M1216	3018810
1408	3003170	2163	3051145	3411100	3016695	1142007G	3005012	1173M1620	3018812
1410	3005610	2164	3051150	3412011	3016635	1142007N	3005011	1173M2025	3018814
1411	3005615	2171	3051310	3412016	3016657	1142009G	3005017	1173M2532	3018816
1412	3005620	2172	3051315	3412021	3016685	1142009N	3005016	1173M3240	3018820
1414	3005630	2173	3051320	3412029	3016705	1142011G	3005022	1253M12	3006750
1415	3005635	2174	3051325	3422016	3016658	1142011N	3005021	1253M12N	3006751
1700	3003015	2176	3051430	3431100	3016895	1142013G	3005027	1253M16	3006755
1701	3003020	2323	3052010	3441012	3017045	1142013N	3005026	1253M16N	3006756
1702	3003025	2326	3052020	3441034	3017065	1142016G	3005032	1253M20	3006760
1703	3003030	2329	3052030	3572007	3017410	1142016N	3005031	1253M20N	3006761
1704	3003035	2333	3052110	3572011	3017430	1142021G	3005037	1253M25	3006765
1705	3003040	2336	3052120	3572013	3017445	1142021N	3005036	1253M25N	3006766
1706	3003045	2339	3052130	3572016	3017455	1142029G	3005042	1253M32	3006770
1707	3003050	2342	3052140	3572021	3017480	1142029N	3005041	1253M32N	3006771
1708	3003055	2344	3052150	6010.114	3016070	1142036G	3005047	1253M40	3006775
1709	3003010	2346	3052160	7032007	3010604	1142036N	3005046	1253M40N	3006776
1710	3005515	3601	3026020	7032009	3010606	1142042G	3005052	1253M50	3006780
1711	3005520	3602	3026030	7032011	3010608	1142042N	3005051	1253M50N	3006781
1712	3005525	3603	3026040	7032013	3010610	1142048G	3005057	1253M63	3006785
1713	3005530	180709	3017610	7032016	3010614	1142048N	3005056	1253M63N	3006786
1714	3005535	180911	3017620	7032021	3010616	1143M12	3005215	1401B	3003116
1715	3005540	180913	3017625	7032029	3010618	1143M12G	3005217	1401BN	3003117
1719	3005510	181113	3017630	7032036	3010620	1143M12N	3005216	1401N	3003115
1830	3004110	181116	3017640	7032042	3010622	1143M16	3005220	1402N	3003121
1831	3004115	181316	3017650	7032048	3010624	1143M16G	3005222	1410N	3005611
1832	3004120	181321	3017655	35720131	3017446	1143M16N	3005221	1411N	3005616
1835	3004222	181621	3017660	5116660250	3061210	1143M20	3005225	1412N	3005621
1836	3004225	182129	3017670	5116660500	3061215	1143M20G	3005227	1414N	3005631
1840	3006610	182936	3017680	5313022048	3061605	1143M20N	3005226	1415N	3005636
1841	3006615	183642	3017690	5523036090	3061610	1143M25	3005230	1500.07	3002010
1842	3006620	184248	3017700	5527030079	3061615	1143M25G	3005232	1500.07N	3002011
1843	3006625	1052007	3005900	1719E17	3005581	1143M25N	3005231	1500.09	3002015
1844	3006630	1052009	3005903	1714E34	3005572	1143M32	3005235	1500.09N	3002016
1845	3006635	1052011	3005906	1052007N	3005901	1143M32G	3005237	1500.11	3002020
1846	3006640	1052013	3005909	1052009N	3005904	1143M32N	3005236	1500.11N	3002021
1847	3006645	1052016	3005912	1052011N	3005907	1143M40	3005240	1500.12	3002120
1848	3006650	1052021	3005915	1052013N	3005910	1143M40G	3005242	1500.12N	3002121
1849	3006655	1052029	3005918	1052016N	3005913	1143M40N	3005241	1500.13	3002025
1861	3004515	1052036	3005921	1052021N	3005916	1143M50	3005245	1500.13N	3002026
1862	3004520	1052042	3005924	1052029N	3005919	1143M50G	3005247	1500.14	3002110
1866	3004615	1052048	3005927	1052036N	3005922	1143M50N	3005246	1500.14N	3002111
1880	3016215	1141012	3005120	1052042N	3005925	1143M63	3005250	1500.16	3002030
1881	3016220	1141112	3005155	1052048N	3005928	1143M63G	3005252	1500.16N	3002031
1882	3016225	1141200	3005170	1053M12	3005958	1143M63N	3005251	1500.21	3002035
1883	3016230	1142007	3005010	1053M12N	3005959	1150N	3005746	1500.21N	3002036
1884	3016235	1142009	3005015	1053M16	3005961	1153M1612	3018860	1500.34	3002130
1885	3016240	1142011	3005020	1053M16N	3005962	1153M2012	3018862	1500.34N	3002131
1886	3016245	1142013	3005025	1053M20	3005964	1153M2016	3018864	1500.38	3002115
1887	3016250	1142016	3005030	1053M20N	3005965	1153M2016N	3018865	1500.38N	3002116
1888	3016255	1142021	3005035	1053M25	3005967	1153M2512	3018866	1500.M12	3002205
1889	3016405	1142029	3005040	1053M25N	3005968	1153M2516	3018868	1500.M12N	3002206
1890	3016410	1142036	3005045	1053M32	3005970	1153M2520	3018870	1500.M16	3002210
1891	3016430	1142042	3005050	1053M32N	3005971	1153M2520N	3018871	1500.M16N	3002211

Type/Code Cross-Reference chart

Type	Code	Type	Code	Type	Code	Type	Code	Type	Code
1500.M20	3002215	1888/5	3016256	1900.M25	3001230	1901.M25G	3001667	200120041N	3013171
1500.M20N	3002216	1890A	3016420	1900.M25/X	3001319	1901.M25N	3001666	200121221N	3013186
1500.M25	3002220	1891A	3016431	1900.M25G	3001232	1901.M32	3001670	200130021N	3013196
1500.M25N	3002221	1892A	3016450	1900.M25N	3001231	1901.M32G	3001672	200200721N	3013011
1500.M32	3002225	1892B	3016451	1900.M32	3001235	1901.M32N	3001671	200200921N	3013016
1500.M32N	3002226	1893A	3016461	1900.M32/X	3001322	1901.M40	3001675	200201121N	3013021
1618.90	3041350	1899A	3016535	1900.M32G	3001237	1901.M40G	3001677	200201321N	3013026
1626.90	3041360	1899B	3016540	1900.M32N	3001236	1901.M40N	3001676	200201621N	3013031
1636.90	3041370	1900.07	3001010	1900.M40	3001240	1901.M50	3001680	200202121N	3013036
1651.90	3041380	1900.07/X	3001077	1900.M40/X	3001325	1901.M50G	3001682	200202921N	3013041
1676.90	3041390	1900.07G	3001012	1900.M40G	3001242	1901.M50N	3001681	200203621N	3013046
1700.2	3004015	1900.07N	3001011	1900.M40N	3001241	1901.M63	3001685	200204221N	3013051
1700.2N	3004016	1900.09	3001015	1900.M50	3001245	1901.M63G	3001687	200204821N	3013056
1700N	3003016	1900.09/X	3001080	1900.M50/X	3001328	1901.M63N	3001686	2003M1221N	3013215
1700P	3006015	1900.09G	3001017	1900.M50G	3001247	1910.07	3001501	2003M1621N	3013220
1700T	3003515	1900.09N	3001016	1900.M50N	3001246	1910.07N	3001502	2003M2021N	3013225
1700TN	3003516	1900.11	3001020	1900.M63	3001250	1910.09	3001509	2003M2521N	3013230
1701.2	3004020	1900.11/X	3001083	1900.M63/X	3001331	1910.09N	3001510	2003M3221N	3013235
1701.2N	3004021	1900.11G	3001022	1900.M63G	3001252	1910.11	3001526	2003M4021N	3013240
1701N	3003021	1900.11N	3001021	1900.M63N	3001251	1910.11N	3001527	2003M5021N	3013245
1701P	3006020	1900.12	3001120	1900DP.07	3001150	1910.13	3001539	2003M6321N	3013250
1701PN	3006021	1900.12N	3001121	1900DP.09	3001153	1910.13N	3001540	2021012N	3014121
1701T	3003517	1900.13	3001025	1900DP.11	3001156	1910.16	3001552	2021014N	3014111
1701TN	3003518	1900.13/X	3001086	1900DP.13	3001159	1910.16N	3001553	2021034N	3014131
1702.2	3004025	1900.13G	3001027	1900DP.16	3001162	1910.21	3001565	2021038N	3014116
1702.2N	3004026	1900.13N	3001026	1900DP.21	3001165	1910.21N	3001566	2021058N	3014126
1702.5	3004425	1900.14	3001110	1900DP.29	3001168	1910.29	3001578	2021100N	3014136
1702.5N	3004426	1900.14N	3001111	1900DP.36	3001171	1910.29N	3001579	2021112N	3014156
1702CONC	3003523	1900.16	3001030	1900DP.42	3001174	1910.36	3001588	2021114N	3014146
1702CONCN	3003524	1900.16/X	3001089	1900DP.48	3001177	1910.36N	3001589	2021118N	3014141
1702N	3003026	1900.16G	3001032	1900DP.M12	3013380	1910.42	3001592	2021200N	3014171
1702P	3006025	1900.16N	3001031	1900DP.M16	3013383	1910.42N	3001593	2031012N	3015621
1702PN	3006026	1900.21	3001035	1900DP.M20	3013386	1910.48	3001598	2031014N	3015611
1702T	3003519	1900.21/X	3001092	1900DP.M25	3013389	1910.48N	3001599	2031034N	3015631
1703.2	3004030	1900.21G	3001037	1900DP.M32	3013392	1910.M12	3001705	2031038N	3015616
1703.5	3004430	1900.21N	3001036	1900DP.M40	3013395	1910.M12G	3001707	2031058N	3015626
1703P	3006030	1900.29	3001040	1900DP.M50	3013398	1910.M12N	3001706	2031100N	3015636
1704.2	3004035	1900.29/X	3001095	1900DP.M63	3013401	1910.M16	3001710	2031112N	3015656
1704P	3006035	1900.29G	3001042	1901.07	3001503	1910.M16G	3001712	2031114N	3015646
1705.2	3004040	1900.29N	3001041	1901.07N	3001504	1910.M16N	3001711	2031118N	3015641
1710N	3005516	1900.34	3001130	1901.09	3001515	1910.M20	3001715	2031200N	3015671
1711N	3005521	1900.34N	3001131	1901.09N	3001516	1910.M20G	3001717	2031212N	3015686
1712N	3005526	1900.36	3001045	1901.11	3001520	1910.M20N	3001716	2031300N	3015696
1713N	3005531	1900.36/X	3001098	1901.11N	3001521	1910.M25	3001720	2032007N	3015511
1714N	3005536	1900.36G	3001047	1901.13	3001535	1910.M25G	3001722	2032009N	3015516
1715N	3005541	1900.36N	3001046	1901.13N	3001536	1910.M25N	3001721	2032011N	3015521
1719E17N	3005580	1900.38	3001115	1901.16	3001550	1910.M32	3001725	2032013N	3015526
1719N	3005511	1900.38N	3001116	1901.16N	3001551	1910.M32G	3001727	2032016N	3015531
1730M20	3003225	1900.42	3001050	1901.21	3001568	1910.M32N	3001726	2032021N	3015536
1730M20N	3003226	1900.42/X	3001101	1901.21N	3001569	1910.M40	3001730	2032029N	3015541
1830N	3004111	1900.42G	3001052	1901.29	3001575	1910.M40G	3001732	2032036N	3015546
1831N	3004116	1900.42N	3001051	1901.29N	3001576	1910.M40N	3001731	2032042N	3015551
1832N	3004121	1900.48	3001055	1901.36	3001582	1910.M50	3001735	2032048N	3015556
1836N	3004226	1900.48/X	3001104	1901.36N	3001583	1910.M50G	3001737	2033M12N	3015751
1840N	3006611	1900.48G	3001057	1901.42	3001590	1910.M50N	3001736	2033M16N	3015756
1841N	3006616	1900.48N	3001056	1901.42N	3001591	1910.M63	3001740	2033M20N	3015761
1842N	3006621	1900.M12	3001215	1901.48	3001596	1910.M63G	3001742	2033M25N	3015766
1843N	3006626	1900.M12/X	3001310	1901.48N	3001597	1910.M63N	3001741	2033M32N	3015771
1844N	3006631	1900.M12G	3001217	1901.M12	3001650	1925.3	3016470	2033M40N	3015776
1845N	3006636	1900.M12N	3001216	1901.M12G	3001652	200101241N	3013121	2033M50N	3015781
1846N	3006641	1900.M16	3001220	1901.M12N	3001651	200101441N	3013111	2033M63N	3015786
1847N	3006646	1900.M16/X	3001313	1901.M16	3001655	200103441N	3013131	20420907N	3017810
1848N	3006651	1900.M16G	3001222	1901.M16G	3001657	200103841N	3013116	20421107N	3017820
1849N	3006656	1900.M16N	3001221	1901.M16N	3001656	200105841N	3013126	20421109N	3017822
1861N	3004516	1900.M20	3001225	1901.M20	3001660	200110041N	3013136	20421307N	3017830
1862N	3004521	1900.M20/X	3001316	1901.M20G	3001662	200111241N	3013156	20421309N	3017832
1866N	3004616	1900.M20G	3001227	1901.M20N	3001661	200111441N	3013146	20421311N	3017835
1884A	3016236	1900.M20N	3001226	1901.M25	3001665	200111841N	3013141	20421607N	3017840

Type/Code Cross-Reference chart

Type	Code	Type	Code	Type	Code	Type	Code	Type	Code
20421609N	3017842	20M3M1261N	3011410	2910.07N	3012501	2A200-2M20	2509994	36A3M2537	3016934
20421611N	3017845	20M3M1661N	3011412	2910.09N	3012511	2A200-M20	2509989	36A3M2545	3016936
20421613N	3017847	20M3M2061N	3011414	2910.11N	3012521	2A24-2M12	2505490	36A3M2546	3016937
20422111N	3017850	20M3M2561N	3011416	2910.13N	3012531	2A24-2M14	2505560	36A3M2554	3016938
20422113N	3017855	20M3M3261N	3011418	2910.16N	3012541	2A24-2M16	2505590	36A3M3228	3016944
20422116N	3017858	20M3M4061N	3011420	2910.21N	3012551	2A24-M10	2505030	36A3M3239	3016946
20422916N	3017860	20M3M5061N	3011422	2910.29N	3012555	2A24-M12	2505150	36A3M32465	3016945
20422921N	3017865	20M3M6361N	3011424	2910.36N	3012560	2A24-M14	2505230	36A3M3248	3016943
20423621N	3017870	20N3M12N	3015810	2910.42N	3012565	2A24-M16	2505310	36A3M40106	3016954
20423629N	3017875	20N3M16N	3015812	2910.48N	3012570	2A24-M20	2505390	36A3M4078	3016952
20424236N	3017885	20N3M20N	3015814	2910.M12N	3012710	2A30-2M12	2506400	36A3M5088	3016968
20424836N	3017890	20N3M25N	3015816	2910.M16N	3012712	2A30-2M14	2506410	36C201629	3016982
20424842N	3017895	20N3M32N	3015818	2910.M20N	3012714	2A30-M10	2506020	36C3M252105	3016985
20431612N	3017949	20N3M40N	3015820	2910.M25N	3012716	2A30-M12	2506030	4300-3127	2590942
20432012N	3017951	20N3M50N	3015822	2910.M32N	3012718	2A30-M14	2506110	4300-3128	2590930
20432016N	3017953	20N3M63N	3015824	2910.M40N	3012720	2A30-M16	2506190	4300-3129	2590931
20432512N	3017955	2900.07N	3012010	2910.M50N	3012722	2A30-M20	2506270	4300-3132	2590957
20432516N	3017957	2900.09N	3012015	2910.M63N	3012724	2A37-2M12	2507420	4300-3136	2590950
20432520N	3017959	2900.11N	3012020	2911.07N	3012110	2A37-2M14	2507440	4300-3137	2590934
20433220N	3017961	2900.13N	3012025	2911.09N	3012113	2A37-2M16	2507490	4300-3138	2590954
20433225N	3017963	2900.16N	3012030	2911.11N	3012116	2A37-M12	2507070	4300-3140	2590951
20434025N	3017965	2900.21N	3012035	2911.13N	3012119	2A37-M14	2507110	4300-3144	2590958
20434032N	3017967	2900.29N	3012040	2911.16N	3012122	2A37-M16	2507190	4300-3146	2590947
20435032N	3017969	2900.36N	3012045	2911.21N	3012125	2A37-M20	2507270	4300-3147	2590938
20435040N	3017971	2900.42N	3012050	2911.29N	3012128	2A3-M10	2500070	4300-3148	2590939
20436340N	3017973	2900.48N	3012055	2911.36N	3012131	2A3-M8	2500030	4300-3153	2590943
20436350N	3017975	2900.M12N	3012215	2911.42N	3012134	2A48-2M12	2508380	4300-3154	2590944
2052007N	3011810	2900.M16N	3012220	2911.M12N	3012750	2A48-2M14	2508410	4300-3241	2590935
2052009N	3011815	2900.M20N	3012225	2911.M16N	3012752	2A48-2M16	2508430	4300-3258	2590932
2052011N	3011820	2900.M25N	3012230	2911.M20N	3012754	2A48-M12	2508030	4300-3262	2590933
2052013N	3011825	2900.M32N	3012235	2911.M25N	3012756	2A48-M14	2508070	4300-3539	2590959
2052016N	3011830	2900.M40N	3012240	2911.M32N	3012758	2A48-M16	2508110	4300-3540	2590960
2052021N	3011835	2900.M50N	3012245	2911.M40N	3012760	2A48-M20	2508190	4300-3541	2590961
2052029N	3011840	2900.M63N	3012250	2911.M50N	3012762	2A5-M10	2500570	4320-0864	2591274
2052036N	3011845	2900DP.07N	3012160	2A100-2M12	2509742	2A5-M12	2500650	4320-0865	2591272
2052042N	3011850	2900DP.09N	3012162	2A100-2M14	2509760	2A5-M8	2500530	4320-0866	2591273
2052048N	3011855	2900DP.11N	3012164	2A100-2M16	2509780	2A60-2M12	2508700	4900.07	3002710
2053M12N	3011910	2900DP.13N	3012166	2A100-M16	2509630	2A60-2M14	2508760	4900.09	3002713
2053M16N	3011915	2900DP.16N	3012168	2A100-M20	2509670	2A60-2M16	2508770	4900.11	3002716
2053M20N	3011920	2900DP.21N	3012170	2A10-2M12	2502410	2A60-M12	2508480	4900.13	3002719
2053M25N	3011925	2900DP.29N	3012172	2A10-M10	2502070	2A60-M14	2508500	4900.16	3002722
2053M32N	3011930	2900DP.36N	3012174	2A10-M12	2502150	2A60-M16	2508530	4900.21	3002725
2053M40N	3011935	2900DP.42N	3012176	2A10-M14	2502190	2A60-M20	2508610	4900.29	3002728
2053M50N	3011940	2900DP.48N	3012178	2A10-M16	2502230	2A7-M10	2501110	4900.36	3002731
2053M63N	3011945	2900DP.M12N	3012315	2A120-2M12	2509910	2A7-M12	2501150	4900.42	3002734
207101441N	3013608	2900DP.M16N	3012317	2A120-2M14	2509930	2A7-M8	2501030	4900.48	3002737
20931216N	3017705	2900DP.M20N	3012319	2A120-2M14/55	2509952	2A80-2M12	2509310	4900.M12	3002750
20931620N	3017707	2900DP.M25N	3012321	2A120-2M16	2509970	2A80-2M14	2509350	4900.M16	3002753
20932025N	3017709	2900DP.M32N	3012323	2A120-M16	2509870	2A80-2M14/55	2509346	4900.M20	3002756
20932532N	3017711	2900DP.M40N	3012325	2A120-M20	2509890	2A80-2M16	2509390	4900.M25	3002759
20932540N	3017713	2900DP.M50N	3012327	2A14-2M12	2503310	2A80-M12	2509030	4900.M32	3002762
20933240N	3017715	2900DP.M63N	3012329	2A14-2M14	2503315	2A80-M14	2509070	4900.M40	3002765
20933250N	3017717	2901.07N	3012590	2A14-M10	2503030	2A80-M16	2509150	4900.M50	3002768
20934050N	3017719	2901.09N	3012593	2A14-M12	2503110	2A80-M20	2509230	4900.M63	3002771
20935063N	3017721	2901.11N	3012596	2A14-M14	2503150	3573M16	3017520	4901.07	3002910
20A40916N	3018650	2901.13N	3012599	2A14-M16	2503190	3573M20	3017530	4901.09	3002913
20A41120N	3018655	2901.16N	3012602	2A160-2M14	8008603	3573M25	3017540	4901.11	3002916
20A41320N	3018657	2901.21N	3012605	2A160-2M16	2509982	3573M32	3017550	4901.13	3002919
20A41620N	3018659	2901.29N	3012608	2A160-M20	2509980	36A3M1623	3016910	4901.16	3002922
20A42011N	3018610	2901.36N	3012611	2A19-2M12	2504480	36A3M1624	3016912	4901.21	3002925
20A42016N	3018612	2901.42N	3012614	2A19-2M14	2504510	36A3M16322	3016913	4901.29	3002928
20A42120N	3018661	2901.M12N	3012650	2A19-M10	2504030	36A3M2025	3016920	4901.36	3002931
20A42125N	3018665	2901.M16N	3012652	2A19-M12	2504110	36A3M2026	3016924	4901.42	3002934
20A42513N	3018615	2901.M20N	3012654	2A19-M14	2504190	36A3M2034	3016922	4901.48	3002937
20A42516N	3018617	2901.M25N	3012656	2A19-M16	2504270	36A3M2035	3016925	4901.M12	3002950
20A42925N	3018667	2901.M32N	3012658	2A19-M20	2504350	36A3M20356	3016923	4901.M16	3002953
20A43216N	3018620	2901.M40N	3012660	2A200-2M12	2509993	36A3M2526	3016930	4901.M20	3002956
20A43221N	3018621	2901.M50N	3012662	2A200-2M16	2509985	36A3M2536	3016932	4901.M25	3002959

Type/Code Cross-Reference chart

Type	Code	Type	Code	Type	Code	Type	Code	Type	Code
4901.M32	3002962	7900.M16	3010113	A120-M16	2372070	A19-M8	2260150	A30-2M10-24-28	2301260
4901.M40	3002965	7900.M20	3010116	A120-M20	2372150	A1-L6	2103200	A30-2M102428/345	2301262
4901.M50	3002968	7900.M25	3010119	A12-M10	2230270	A1-M10	2103270	A30-2M12	2301370
4901.M63	3002971	7900.M32	3010122	A12-M10/19	2230280	A1-M3	2103030	A30-2M12-30	2301350
5900.M12N	3012810	7900.M40	3010125	A12-M12	2230310	A1-M3.5	2103070	A30-2M12-30-29	2301359
5900.M16N	3012812	7900.M50	3010128	A12-M6/15	2230210	A1-M4	2103110	A30-2M123029/345	2301360
5900.M20N	3012814	7900.M63	3010131	A12-M8	2230230	A1-M5	2103150	A30-2M12-40	2301367
5900.M25N	3012816	7900A.07	3010060	A14-2M10	8008438	A1-M6	2103190	A30-2M14	2301650
5900.M32N	3012818	7900A.09	3010062	A14-2M10-24	2241565	A1-M8	2103230	A30-2M14-33.5	2301653
5900.M40N	3012820	7900A.11	3010064	A14-2M102426/315	2241570	A200-M16	2376090	A30-2M8-20	2301250
5900.M50N	3012822	7900A.13	3010066	A14-2M102426/345	2241572	A200-M20	2376100	A30-2M8-2429/345	2301255
5900.M63N	3012824	7900A.16	3010068	A14-2M12	2241605	A20-M10	2270270	A30B-M10/19	2300120
5901.M12N	3012850	7900A.21	3010070	A14-2M12-25	2241590	A20-M12	2270310	A30B-M8/19	2300080
5901.M16N	3012852	7900A.29	3010072	A14-2M12-30-29	2241592	A20-M14	2270350	A30-L10	2300870
5901.M20N	3012854	7900A.36	3010074	A14-2M123029/345	2241593	A20-M16	2270390	A30-L12	2300910
5901.M25N	3012856	7900A.42	3010076	A14-2M12-40	2241600	A20-M8	2270230	A30-M10	2300110
5901.M32N	3012858	7900A.48	3010078	A14-2M14	2241620	A2-M4-12	2170750	A30-M12	2300150
5901.M40N	3012860	7900A.M12	3010150	A14-2M8	2241555	A2-2M8-20	2170770	A30-M14	2300230
5901.M50N	3012862	7900A.M16	3010152	A14-2M8-24-24	2241552	A24-2M10	2281810	A30-M16	2300270
6010.01	3016090	7900A.M20	3010154	A14-2M8-2424/345	2241550	A24-2M10-22	2281815	A30-M20	2300350
6010.11	3016030	7900A.M25	3010156	A14B-M6/11.5	2240118	A24-2M102429/345	2281827	A30-M8	2300070
6010.12	3016040	7900A.M32	3010158	A14-L10	2241250	A24-2M10-25/24	2281817	A3-2M12-40	2181751
6010.14	3016010	7900A.M40	3010160	A14-L12	2241290	A24-2M10-33.5	2281825	A3-2M8-20	2181750
6010.21	3016080	7900A.M50	3010162	A14-L16	2241294	A24-2M12	2281930	A35-M10	2301265
6010.29	3016100	7900A.M63	3010164	A14-L8	2241245	A24-2M12-30-29	2281910	A35-M12	2310270
6010.34	3016060	A03-M3	2100030	A14-M10	2240230	A24-2M123029/345	2281911	A35-M14	2310310
6010.36	3016110	A03-M3.5	2100070	A14-M12	2240270	A24-2M12-40	2281920	A35-M16	2310350
6010.38	3016020	A03-M4	2100110	A14-M14	2240310	A24-2M14	2282210	A35-M20	2310390
6010.42	3016120	A03-M5	2100150	A14-M16	2240350	A24-2M16	2282213	A37-2M10	2320902
6010.48	3016130	A03-M6	2100190	A14-M6	2240110	A24-2M8-20	2281780	A37-2M10-25	2320890
6010.58	3016050	A06-M3	2101030	A14-M8	2240150	A24-2M8-24-29	2281790	A37-2M10-25/315	2320891
7032A007	3010628	A06-M3.5	2101070	A14-P30	2241730	A24-2M8-2429/345	2281791	A37-2M12	2320910
7032A009	3010630	A06-M4	2101110	A160-2M12	8008330	A24B-2M8-25/19	2281777	A37-2M12-30-31	2320919
7032A011	3010632	A06-M5	2101150	A160-2M16	8008432	A24B-2M8-45/19	2281779	A37-2M123031/345	2320920
7032A013	3010634	A06-M6	2101190	A160-4ESI	2374350	A24B-M10/19	2280155	A37-2M12-32	2320915
7032A016	3010636	A06-M8	2101230	A160-M16	2374150	A24B-M8/19	2280115	A37-2M14	2320970
7032A021	3010638	A100-2M12	8008538	A160-M20	2374170	A24-L10	2281010	A37-2M14-35	2320950
7032A029	3010640	A100-2M16	2370350	A17-M10	2250270	A24-L12	2281050	A37-2M16	8008485
7032A036	3010642	A100-4ESI	2370990	A17-M10/19	2250280	A24L-2M10-30A5	2281840	A37-2M16-40	2320990
7032A042	3010644	A100-M16	2370030	A17-M12	2250310	A24-M10	2280150	A37-4ESI	2321510
7032A048	3010646	A100-M20	2370110	A17-M14	2250350	A24-M12	2280190	A37B-M10/24.5	2320120
7033AM12	3010670	A10-2M10	8008442	A17-M16	2250860	A24-M14	2280230	A37-L10	2320510
7033AM16	3010672	A10-2M10-24-13	2221493	A17-M6	2250210	A24-M16	2280270	A37-L12	2320550
7033AM20	3010674	A10-2M12	2221480	A17-M8	2250230	A24-M20	2280310	A37-M10	2320110
7033AM25	3010676	A10-2M12-25	2221470	A19-2M10	2261363	A24-M8	2280110	A37-M12	2320150
7033AM32	3010678	A10-2M6	2221463	A19-2M10-24-13	2261348	A29-M10	2290270	A37-M14	2320190
7033AM40	3010680	A10-2M8	8008434	A19-2M10-24-26	2261350	A29-M12	2290310	A37-M16	2320230
7033AM50	3010682	A10-2M8-20	2221465	A19-2M102426/345	2261351	A29-M14	2290350	A37-M20	2320270
7033AM63	3010684	A10-2M8-22	2221464	A19-2M10-40	2261360	A29-M16	2290390	A37-M8	2320070
7033M12	3010652	A10-2M8-24-24	2221467	A19-2M12	2261385	A29-M20	2290430	A3-L10	2180659
7033M16	3010654	A10-2M8-2424/345	2221466	A19-2M12-25	2261370	A29-M8	2290230	A3-L12	2180670
7033M20	3010656	A10-2M8-30	2221468	A19-2M12-30-29	2261379	A2-L10	2170860	A3-L5	2180620
7033M25	3010658	A10B-M6/11.5	2220078	A19-2M123029/345	2261380	A2-L12	2170870	A3-L6	2180630
7033M32	3010660	A10-L10	2220650	A19-2M14	8008318	A2-L4	2170810	A3-L8	2180640
7033M40	3010662	A10-L12	2220690	A19-2M14-25	2261400	A2-L5	2170820	A3-M10	2180270
7033M50	3010664	A10-L16	2220700	A19-2M16	2261420	A2-L6	2170830	A3-M12	2180310
7033M63	3010666	A10-L6	2220605	A19-2M6	2261220	A2-L8	2170850	A3-M4	2180030
7900.07	3010000	A10-L8	2220610	A19-2M8-2424/345	2261330	A2-M10	2170270	A3-M5	2180110
7900.09	3010005	A10-M10	2220150	A19B-M8/15.5	2260163	A2-M12	2170310	A3-M5/9	2180120
7900.11	3010010	A10-M12	2220190	A19-L10	2260570	A2-M4	2170070	A3-M6	2180150
7900.13	3010015	A10-M14	2220230	A19-L12	2260610	A2-M5	2170150	A3-M8	2180190
7900.16	3010020	A10-M16	2220270	A19-L8	2260560	A2-M5/9	2170155	A3-P14	2180830
7900.21	3010025	A10-M6	2220070	A19-M10	2260190	A2-M6	2170190	A3-P22R	2180840
7900.29	3010030	A10-M8	2220110	A19-M12	2260230	A2-M8	2170230	A3-P22R/45	2180843
7900.36	3010035	A10-P25	2221990	A19-M14	2260270	A2-P12	2170650	A3-U4	2181990
7900.42	3010040	A120-2M12	2372490	A19-M16	2260310	A2-U4	2170510	A3-U5	2182000
7900.48	3010045	A120-2M16	2372510	A19-M20	2260390	A2-U5	2170520	A40-M10	2330230
7900.M12	3010110	A120-4ESI	2372850	A19-M6	2260110	A30-2M10	2301280	A40-M12	2330270

Type/Code Cross-Reference chart

Type	Code	Type	Code	Type	Code	Type	Code	Type	Code
A40-M14	2330310	A7-2M10	8008441	AAD185-M12	8016846	ANE24-M12	2453550	B1300-CA-KV	2599389
A40-M16	2330350	A7-2M10-25	2201190	AAD185-M16	8016848	ANE24-M14	2453570	B1300-CE-KV	2599390
A40-M20	2330390	A7-2M12	2200998	AAD185-M20	8016850	ANE24-M16	2453590	B1300-CT-KV	2599391
A48-2M10	2340750	A7-2M12-25	2200990	AAD240-M12	8016852	ANE29-M10	2456010	B1300-UC	2599365
A48-2M10-20	2340730	A7-2M12-40	2200995	AAD240-M16	8016854	ANE29-M12	2456030	B1300-UCA	2599366
A48-2M10-35	2340740	A7-2M8	8008632	AAD240-M20	8016856	ANE29-M14	2456050	B1300-UCE	2599367
A48-2M12	2340820	A7B-M6/11.5	2200120	AAD25-M10	8016806	ANE29-M16	2456070	B1300-UCT	2599368
A48-2M12/345	2340775	A7-L10	2200790	AAD25-M8	8016804	ANE29-M20	2456090	B1300L-C	2599358
A48-2M12-30/45	2340765	A7-L12	2200830	AAD300-M12	8016858	ANE2-M10	2408840	B1300L-CA	2599359
A48-2M12-30-31	2340770	A7-L6	2200710	AAD300-M16	8016860	ANE2-M12	2408845	B1300L-CE	2599360
A48-2M123031/345	2340771	A7-L8	2200750	AAD300-M20	8016862	ANE2-M4	2408820	B1300L-CT	2599361
A48-2M12-35	2340790	A7-M10	2200190	AAD35-M10	8016810	ANE2-M5	2408825	B1300L-C-KV	2599380
A48-2M12-40	2340810	A7-M12	2200230	AAD35-M12	8016812	ANE2-M6	2408830	B1300L-CA-KV	2599381
A48-2M14	2340860	A7-M5	2200070	AAD35-M8	8016808	ANE2-M8	2408835	B1300L-CE-KV	2599382
A48-2M14-40	2340850	A7-M6	2200110	AAD400-M12	8016864	ANE2-P12	2408850	B1300L-CT-KV	2599383
A48-2M16	2340870	A7-M8	2200150	AAD400-M16	8016866	ANE2-U4	2408860	B1300PL	2598542
A48-4ESI	2340950	A7-P20	2201750	AAD400-M20	8016868	ANE2-U5	2408865	B1300PLA	2598541
A48-L10	2341293	A80-2M12	2360450	AAD500-M12	8016870	ANE30-M12	2458320	B1300PLE	2598555
A48-L12	2341295	A80-2M14	2360510	AAD500-M16	8016872	ANE30-M14	2458350	B1300PLT	2598539
A48-M10	2340110	A80-2M14-40	2360500	AAD500-M20	8016874	ANE30-M16	2458370	B1350-C	2599320
A48-M10/31	2340120	A80-2M16	2360605	AAD50-M10	8016816	ANE30-M20	2458390	B1350-CA	2599322
A48-M12	2340150	A80-2M16/41	8008382	AAD50-M12	8016818	ANE35-M12	2460010	B1350-CE	2599323
A48-M12/31	2340158	A80-2M16-40	2360600	AAD50-M8	8016814	ANE35-M14	2460030	B1350-CT	2599324
A48-M14	2340190	A80-2M16-50	2360610	AAD70-M10	8016820	ANE35-M16	2460050	B1350-C-KV	2599340
A48-M16	2340230	A80-4ESI	2360850	AAD70-M12	8016822	ANE35-M20	2460070	B1350-CA-KV	2599341
A48-M16/31	2340238	A80B-2M16-40	2360601	AAD70-M16	8016824	ANE3-M10	2415840	B1350-CE-KV	2599342
A48-M20	2340310	A80-M12	2360030	AAD95-M10	8016826	ANE3-M12	2415850	B1350-CT-KV	2599343
A48-M8	2340070	A80-M14	2360070	AAD95-M12	8016828	ANE3-M4	2415800	B1350L-C	2599327
A5-2M10-24-13	2190470	A80-M16	2360110	AAD95-M16	8016830	ANE3-M5	2415810	B1350L-CA	2599328
A5-2M12-3029/345	2190480	A80-M20	2360150	AB13	3041530	ANE3-M6	2415820	B1350L-CE	2599329
A5-2M8-20	2190450	A9-M10	2210270	AB13N	3041531	ANE3-M8	2415830	B1350L-CT	2599330
A5-2M8-24-24	2190460	A9-M12	2210310	AB19	3041532	ANE3-P14	2415860	B1350L-C-KV	2599345
A5-2M8-24-24/345	2190461	A9-M6/15	2210210	AB19N	3041533	ANE3-U4	2415870	B1350L-CA-KV	2599346
A5-L10	2190750	A9-M8	2210230	AB28	3041534	ANE3-U5	2415875	B1350L-CE-KV	2599357
A5-L12	2190760	AA120-M12	2741510	AB28N	3041535	ANE5-M10	2418540	B1350-UC	2599335
A5-L4	2190620	AA120-M14	2741550	AC130-P	2615531	ANE5-M12	2418550	B1350-UCE	2599336
A5-L5	2190630	AA150-M12	2742030	ANE10-M10	2439370	ANE5-M4	2418500	B1350-UCA	2599337
A5-L6	2190670	AA150-M14	2742070	ANE10-M12	2439380	ANE5-M5	2418510	B1350-UCT	2599338
A5-L8	2190710	AA16-M8	2740020	ANE10-M6	2439350	ANE5-M6	2418520	B450ND-BV	2596235
A5-M10	2190190	AA185-M12	2742510	ANE10-M8	2439360	ANE5-M8	2418530	B450ND-BVE	2596236
A5-M12	2190230	AA185-M14	2742550	ANE12-M10	2442220	ANE5-P16	2418560	B450ND-BVT	2596237
A5-M4	2190030	AA240-M12	2743030	ANE12-M10/19	2442225	ANE7-M10	2422320	B500	2596205
A5-M5	2190070	AA240-M14	2743070	ANE12-M12	2442230	ANE7-M12	2422330	B500A	2596211
A5-M5/9	2190075	AA25-M8	2740050	ANE12-M6/15	2442200	ANE7-M6	2422300	B500E	2596212
A5-M6	2190110	AA300-34-M12	2743205	ANE12-M8	2442210	ANE7-M8	2422310	B500T	2596213
A5-M8	2190150	AA300-34-M14	2743210	ANE14-M10	2446430	ANE7-P20	2422360	B500-KV	2596207
A5-P16	2191510	AA300-34-M16	2743215	ANE14-M12	2446440	ANE9-M10	2430170	B500A-KV	2596206
A5-P22R	2191515	AA300-M16	2743150	ANE14-M14	2446450	ANE9-M12	2430180	B500E-KV	2596208
A5-P22R/45	2191518	AA35-M10	2740075	ANE14-M6	2446410	ANE9-M6/15	2430150	B500T-KV	2596209
A60-2M10	2350580	AA35-M8	2740070	ANE14-M8	2446420	ANE9-M8	2430160	B500ND	2596220
A60-2M12	2350600	AA400-M16	2743310	ANE17-M10	2447260	ASC55-EU	2598485	B500NDA	2596221
A60-2M12-30-38	2350620	AA500-40-M16	2743330	ANE17-M10/19	2447265	ASC-ULTRA-EU	2598471	B500NDE	2596222
A60-2M123038/345	2350621	AA50-M12	2740110	ANE17-M12	2447270	AU130-150	2615560	B500NDT	2596223
A60-2M12-40	2350610	AA50-M14	2740150	ANE17-M14	2447280	AU130-240	2615590	B540ND6	2599979
A60-2M14	2350660	AA630-M16	2743370	ANE17-M16	2447290	AU230-130-D	2636960	B600C	2596217
A60-2M16	2350740	AA70-M12	2740510	ANE17-M6	2447240	AU230-630	2680300	B600CND	2596218
A60-2M16/36	8008380	AA70-M14	2740550	ANE17-M8	2447250	AU520-130-C	2648230	B68M-P18	2596163
A60-2M16-35	2350750	AA95-M12	2741030	ANE19-M10	2449520	AU55-50	2672515	B68M-P18A	2596164
A60-2M16-40	2350730	AA95-M14	2741070	ANE19-M12	2449530	AU55-W	2672511	B68M-P18E	2596165
A60-4ESI	2350850	AAD120-M10	8016832	ANE19-M14	2449540	B15MD	2599837	B68M-P18T	2596166
A60B-M10/31	2350033	AAD120-M12	8016834	ANE19-M16	2449550	B15MA	2599841	B68RC3-85	2597970
A60B-M12/31	2350072	AAD120-M16	8016836	ANE19-M8	2449510	B15MDE	2599839	B68RC3-96	2597972
A60-L12	2351010	AAD150-M10	8016838	ANE20-M10	2451320	B15MDT	2599840	B68RC3-120	2597974
A60-M10	2350030	AAD150-M12	8016840	ANE20-M12	2451330	B1300-C	2599350	B70M-P36	2596030
A60-M12	2350070	AAD150-M16	8016842	ANE20-M14	2451340	B1300-CA	2599351	B70M-P36A	2596031
A60-M14	2350150	AAD150-M20	8016844	ANE20-M16	2451350	B1300-CE	2599352	B70M-P36E	2596032
A60-M16	2350190	AAD16-M10	8016802	ANE20-M8	2451310	B1300-CT	2599353	B70M-P36T	2596033
A60-M20	2350230	AAD16-M8	8016800	ANE24-M10	2453530	B1300-C-KV	2599388	B70M-P36-CH	2596046

Type/Code Cross-Reference chart

Type	Code	Type	Code	Type	Code	Type	Code	Type	Code
B70M-P36A-CH	2596040	BKY-M8	2145871	BP-PP16/25	2046455	B-TC4500T	2599419	C2-12	2395900
B70M-P36E-CH	2596039	BKY-P10	2145932	BP-PPL30	2046470	B-TC500	2598827	C2-14	2395840
BA-3	2598424	BKY-P12	2145934	BP-PPL46	2046475	B-TC500A	2598828	C2-38	2395880
BF-BF5	2053630	BKY-P8	2145930	BPS230.14	2598500	B-TC500E	2598829	C240-C120	2490760
BF-BM5	2053660	BKY-PP12	2145940	BPS230.96	2598497	B-TC500T	2598819	C240-C120ST	2492760
BF-F405	2053560	BKY-PP12/25	2145942	BP-U10	2046565	B-TC500ND-SC	2596300	C250-12	2397080
BF-F405P	2053565	BKY-PP16/23	2145944	BP-U12	2046570	B-TC500ND-SCA	2596302	C250-14	2397020
BF-F408	2053570	BKY-PPL30	2145950	BP-U3	2046510	B-TC500ND-SCE	2596301	C250-34	2397140
BF-F408P	2053575	BKY-PPL46	2145952	BP-U3.5	2046515	B-TC500ND-SCT	2596303	C250-38	2397060
BF-F608	2053610	BKY-U3	2145900	BP-U3.5/1	2046516	B-TC500Y	2598815	C250-516	2397040
BF-F608P	2053620	BKY-U3.5	2145903	BP-U4	2046530	B-TC500YA	2598816	C250-58	2397120
BF-FM608	2053690	BKY-U4	2145906	BP-U4/1	2046531	B-TC500YE	2598817	C250-78	2397160
BF-M10	2052390	BKY-U5	2145909	BP-U4/2	2046540	B-TC50	2599420	C250-916	2397100
BF-M12	2052430	BKY-U6	2145912	BP-U5	2046545	B-TC50A	2599421	C2-516	2395860
BF-M2	2052010	BKY-U6/1	2145914	BP-U6	2046555	B-TC50E	2599422	C25-C10	2490150
BF-M3	2052030	BN-FA608	3031640	BP-U6/1	2046556	B-TC50T	2599423	C25-C10ST	2492150
BF-M3.5	2052070	BN-FAB608	3031660	BP-U8	2046560	B-TC650	2599440	C25-C25	2490190
BF-M3.5/1	2052110	BN-FAR608	3031680	BSCL1	2489535	B-TC650A	2599441	C25-C25ST	2492190
BF-M4	2052150	BN-M10	2152390	BSCL1/0	2489540	B-TC650E	2599442	C3/0-12	2396680
BF-M5	2052190	BN-M12	2152430	BSCL2	2489530	B-TC650T	2599443	C3/0-14	2396620
BF-M6	2052230	BN-M2	2152010	BSCL2/0	2489545	B-TC650-SC	2599430	C3/0-34	2396740
BF-M6/1	2052270	BN-M3	2152030	BSCL250	2489560	B-TC650-SCA	2599431	C3/0-38	2396660
BF-M6/2	2052280	BN-M3.5	2152070	BSCL3	2489525	B-TC650-SCE	2599432	C3/0-516	2396640
BF-M608	2053650	BN-M3.5/1	2152110	BSCL3/0	2489550	B-TC650-SCT	2599433	C3/0-58	2396720
BF-M608P	2053655	BN-M4	2152150	BSCL300	2489565	B-TC950	2599460	C3/0-916	2396700
BF-M7	2052310	BN-M5	2152190	BSCL350	2489570	B-TC950A	2599461	C300-12	2397360
BF-M8	2052350	BN-M6	2152230	BSCL4	2489520	B-TC950E	2599462	C300-34	2397420
BF-P10	2053250	BN-M6/1	2152270	BSCL4/0	2489555	B-TC950T	2599463	C300-38	2397340
BF-P12	2053290	BN-M7	2152310	BSCL400	2489575	B-TD270	2598951	C300-516	2397320
BF-P8	2053210	BN-M8	2152350	BSCL500	2489580	B-TD270A	2598952	C300-58	2397400
BF-PP10	2053320	BN-MA608	3031740	BSCL6	2489515	B-TD270E	2598953	C300-78	2397440
BF-PP12	2053330	BN-P10	2153190	BSCL600	2489585	B-TD270T	2598954	C300-916	2397380
BF-PP12/25	2053370	BN-P12	2153230	BSCL750	2489590	B-TD410T	2598945	C3-10	2395640
BF-PP12/29	2053380	BN-P8	2153150	BSCL8	2489510	B-TD410TA	2598946	C3-12	2395720
BF-PP16/25	2053410	BN-PP12	2153270	B-FC470	2598880	B-TD410TE	2598947	C3-14	2395660
BF-PPL30	2053460	BN-PP12/25	2153310	B-FC470A	2598881	B-TD410T-T	2598948	C3-38	2395700
BF-PPL46	2053465	BN-PP16/25	2153350	B-FC470E	2598882	C1/0-12	2396280	C350-12	2397540
BF-U10	2052910	BN-U10	2152910	B-FL750	2598865	C1/0-14	2396220	C350-34	2397600
BF-U12	2052950	BN-U12	2152950	B-FL750A	2598866	C1/0-38	2396260	C350-38	2397520
BF-U3	2052630	BN-U3	2152630	B-FL750E	2598867	C1/0-516	2396240	C350-58	2397580
BF-U3.5	2052670	BN-U3.5	2152670	B-FL750T	2598864	C1/0-58	2396320	C350-78	2397620
BF-U3.5/1	2052671	BN-U3.5/1	2152680	B-FL750ND	2598790	C1/0-916	2396300	C350-916	2397560
BF-U4	2052710	BN-U4	2152710	B-FL750NDA	2598791	C10-C10	2490070	C3-516	2395680
BF-U4/1	2052720	BN-U4/1	2152730	B-FL750NDE	2598792	C10-C10ST	2492070	C35-C16	2490230
BF-U4/2	2052730	BN-U4/2	2152732	B-FL750NDT	2598793	C1-12	2396080	C35-C16ST	2492230
BF-U5	2052750	BN-U5	2152750	B-TC250	2596266	C1-14	2396020	C35-C35	2490270
BF-U5/2	2052765	BN-U6	2152790	B-TC250YA	2596261	C120-C120	2490630	C35-C35ST	2492270
BF-U6	2052790	BN-U6/1	2152830	B-TC250E	2596268	C120-C120ST	2492630	C3-8	2395620
BF-U6/1	2052830	BN-U8	2152870	B-TC250T	2596269	C1-38	2396060	C4/0-12	2396880
BF-U8	2052870	BP-M10	2046345	B-TC250ND	2599540	C150-C120	2490670	C4/0-14	2396820
BKF-BF4	2053632	BP-M12	2046350	B-TC250YND	2599521	C150-C120ST	2492670	C4/0-34	2396940
BKF-BM4	2053662	BP-M2	2046305	B-TC250YNDT	2599523	C150-C150	2490690	C4/0-38	2396860
BKF-F405	2053562	BP-M3	2046310	B-TC250NDE	2599541	C150-C150ST	2492690	C4/0-516	2396840
BKF-F405P	2053567	BP-M3.5	2046315	B-TC250NDT	2599542	C1-516	2396040	C4/0-58	2396920
BKF-F408	2053572	BP-M3.5/1	2046316	B-TC320ND	2596285	C16-C16	2490110	C4/0-916	2396900
BKF-F408P	2053577	BP-M4	2046320	B-TC320NDA	2596286	C16-C16ST	2492110	C400-12	2397740
BKF-F608	2053612	BP-M5	2046325	B-TC320NDE	2596287	C185-C185	2490745	C400-34	2397800
BKF-F608P	2053622	BP-M6	2046330	B-TC320NDT	2596288	C185-C185ST	2492745	C400-38	2397720
BKF-FM608	2053692	BP-M6/1	2046331	B-TC320NDF	2596290	C185-C95	2490710	C400-58	2397780
BKF-M608	2053652	BP-M6/2	2046332	B-TC320NDFA	2596291	C185-C95ST	2492710	C400-78	2397820
BKY-M10	2145874	BP-M7	2046335	B-TC320NDFE	2596292	C2/0-12	2396480	C400-916	2397760
BKY-M12	2145878	BP-M8	2046340	B-TC320NDFT	2596293	C2/0-14	2396420	C4-10	2395440
BKY-M3	2145842	BP-P10	2046415	B-TC450	2599405	C2/0-34	2396540	C4-12	2395520
BKY-M3.5	2145845	BP-P12	2046420	B-TC450A	2599406	C2/0-38	2396460	C4-14	2395460
BKY-M3.5/1	2145847	BP-P8	2046410	B-TC450E	2599407	C2/0-516	2396440	C4-38	2395500
BKY-M4	2145853	BP-PP12	2046440	B-TC4500	2599409	C2/0-58	2396520	C4-516	2395480
BKY-M5	2145856	BP-PP12/25	2046445	B-TC4500A	2599417	C2/0-916	2396500	C4-8	2395420
BKY-M6/1	2145862	BP-PP12/29	2046450	B-TC4500E	2599418	C2-10	2395820	C500-12	2397940

Type/Code Cross-Reference chart

Type	Code	Type	Code	Type	Code	Type	Code	Type	Code
C500-34	2398000	CA25-2M8	2530130	CBP-M3	2076310	CL1/OIH-516	2396409	CL400-12	2397888
C500-38	2397920	CA25-M10	2530050	CBP-M3.5	2076315	CL1-10	2396183	CL400-58	2397894
C500-58	2397980	CA25-M12	2530090	CBP-M3.5/1	2076320	CL1-12	2396191	CL400-D141	2397861
C500-78	2398020	CA25-M8	2530010	CBP-M4	2076325	CL1-516	2396187	CL400-D38	2397870
C500-916	2397960	CA300-2M12	8005806	CBP-M5	2076335	CL1-D14	2396160	CL400-DN	2397875
C50-C25	2490350	CA300-M12	8005604	CBP-M6	2076340	CL1-D141	2396161	CL400IH-12	2397908
C50-C25ST	2492350	CA300-M16	8005608	CBP-M6/1	2076345	CL1-D38	2396170	CL400IH-58	2397914
C50-C50	2490390	CA300-M20	8005610	CBP-M608	2076560	CL1-DN	2396175	CL4-10	2395585
C50-C50ST	2492390	CA315R-2M14	2534430	CBP-M7	2076350	CL1IH-10	2396205	CL4-12	2395597
C59	8420035	CA315R-M14	2534330	CBP-M8	2076355	CL1IH-12	2396217	CL4-14	2395588
C600-12	2398120	CA315S-2M14	2534610	CBP-P10	2076455	CL1IH-516	2396211	CL4-38	2395594
C600-34	2398180	CA315S-M14	2534530	CBP-P12	2076460	CL2/0-12	2396594	CL4-D14	2395560
C600-58	2398160	CA35-2M12	8005726	CBP-P8	2076450	CL2/0-38	2396591	CL4-D141	2395561
C600-78	2398200	CA35-M10	8005524	CBP-PP12	2076480	CL2/0-D14	2396560	CL4-D38	2395570
C600-916	2398140	CA35-M12	8005526	CBP-PP12/25	2076490	CL2/0-D141	2396561	CL4-DN	2395575
C6-10	2395240	CA35-M16	8005530	CBP-PPL30	2076498	CL2/0-D38	2396570	CL4IH-10	2395605
C6-12	2395320	CA40S-2M12	2530510	CBP-U3	2076380	CL2/0-DN	2396575	CL4IH-12	2395617
C6-14	2395260	CA40S-M12	2530450	CBP-U3.5	2076385	CL2/OIH-12	2396611	CL4IH-14	2395608
C6-38	2395300	CA40S-M16	2530490	CBP-U4	2076395	CL2/OIH-38	2396609	CL4IH-38	2395614
C6-516	2395280	CA50-2M12	8005736	CBP-U4/1	2076400	CL2-10	2395985	CL500-12	2398088
C6-8	2395220	CA50R-2M12	2530870	CBP-U4/2	2076405	CL2-12	2395997	CL500-58	2398094
C6-C6	2490030	CA50R-M12	2530790	CBP-U4/3L	2076408	CL2-14	2395988	CL500-D141	2398061
C6-C6ST	2492030	CA50S-2M12	2531190	CBP-U5	2076410	CL250-12	2397204	CL500-D38	2398070
C70-C25N	2490310	CA50S-M12	2531110	CBP-U6	2076415	CL250-D38	2397180	CL500-DN	2398075
C70-C25N-ST	2492310	CA50S-M16	2531150	CC8.9	3041630	CL250-DN	2397185	CL500IH-12	2398108
C70-C35	2490430	CA70-M12	2531870	CC9.12	3041632	CL250IH-12	2397229	CL500IH-58	2398114
C70-C35ST	2492430	CA70S-2M12	2531510	CDD6	2599940	CL2-516	2395991	CL600-12	2398285
C70-C70	2490470	CA70S-M12	2531430	CDD6-8	2599941	CL2-D14	2395960	CL600-58	2398291
C70-C70ST	2492470	CA70S-M16	2531470	CFA2-600	3031942	CL2-D141	2395961	CL600-D38	2398270
C750-12	2398320	CA95-2M12	8005756	CFA300	3031900	CL2-D38	2395970	CL600-DN	2398275
C750-34	2398380	CA95-M10	8005554	CFA400	3031914	CL2-DN	2395975	CL600IH-12	2398305
C750-58	2398360	CA95-M12	8005556	CFA600	3031928	CL2-DN38	2395971	CL600IH-58	2398311
C750-78	2398400	CA95-M16	8005560	CFAB600	3031970	CL2IH-10	2396005	CL6-10	2395385
C8-10	2395040	CA95R-2M14	2532230	CFAR600	3031956	CL2IH-12	2396017	CL6-12	2395397
C8-12	2395120	CA95R-M12	2532150	CFC230N	2598490	CL2IH-14	2396008	CL6-14	2395388
C8-14	2395060	CA95R-M14	2532190	CGP-F608	2076845	CL2IH-516	2396011	CL6-D14	2395360
C8-38	2395100	CA95S-2M14	2532610	CGP-F608P	2076850	CL3/0-12	2396794	CL6-D141	2395361
C8-516	2395080	CA95S-M12	2532450	CGP-M10	2076670	CL3/0-D141	2396761	CL6-D38	2395370
C8-8	2395020	CA95S-M14	2532490	CGP-M3	2076610	CL3/0-D38	2396770	CL6-DN	2395375
C95-C35	2490510	CA95S-M16	2532500	CGP-M3.5	2076615	CL3/0-DN	2396775	CL6IH-10	2395405
C95-C35ST	2492510	CAA10-M12	2760005	CGP-M4	2076625	CL3/OIH-12	2396811	CL6IH-12	2395417
C95-C70	2490550	CAA120-M12	2760310	CGP-M5	2076635	CL300-12	2397491	CL6IH-14	2395408
C95-C70ST	2492550	CAA150-M12	2760350	CGP-M6	2076640	CL300-D38	2397470	CL750-12	2398485
C95-C95	2490590	CAA16-M12	2760012	CGP-M6/1	2076645	CL300-DN	2397475	CL750-58	2398488
C95-C95ST	2492590	CAA185-M12	2760430	CGP-M608	2076860	CL300IH-12	2397509	CL750-D38	2398470
CA120-2M12	8005766	CAA240-M12	2760590	CGP-M7	2076650	CL3-12	2395797	CL750-DN	2398475
CA120-M12	8005566	CAA25-M12	2760030	CGP-M8	2076660	CL3-14	2395788	CL750-DN38	2398471
CA120-M16	8005570	CAA300-34-M12	2760680	CGP-M8/1	2076665	CL3-38	2395794	CL750IH-12	2398505
CA150-2M12	8005776	CAA300-34-M16	2760715	CGP-P10	2076755	CL350-12	2397688	CL750IH-58	2398508
CA150-M12	8005576	CAA300-M16	2760710	CGP-P12	2076760	CL350-D141	2397661	CL8-10	2395183
CA150-M16	8005580	CAA35-M12	2760070	CGP-P14	2076765	CL350-D38	2397670	CL8-14	2395186
CA150R-2M14	2533010	CAA400-M16	2760750	CGP-PP12	2076780	CL350-DN	2397675	CL8-38	2395192
CA150R-M12	2532810	CAA500-M16-TNBD	2760852	CGP-PP17	2076790	CL350IH-12	2397708	CL8-D14	2395160
CA150R-M14	2532850	CAA50-M12	2760110	CGP-U3.5	2076685	CL3-516	2395791	CL8-D141	2395161
CA150S-2M14	2533330	CAA630-4M8	2760950	CGP-U4	2076695	CL3-D38	2395770	CL8-D38	2395170
CA150S-M12	2533210	CAA70-M12	2760150	CGP-U5	2076710	CL3-DN	2395775	CL8IH-10	2395203
CA150S-M14	2533250	CAA95-M12	2760190	CGP-U6	2076715	CL3IH-12	2395817	CL8IH-14	2395206
CA185-2M12	8005786	CB1430H	2598502	CL1/0-10	2396385	CL3IH-14	2395808	CL8IH-38	2395212
CA185-M12	8005586	CB1430L	2598494	CL1/0-12	2396397	CL3IH-38	2395814	CMA600	3031984
CA185-M16	8005590	CB1820L	2598495	CL1/0-38	2396394	CL3IH-516	2395811	CMB1	2599943
CA200R-2M14	2533570	CB1852L	2598514	CL1/0-516	2396391	CL4/0-12	2396994	CMB2	2599945
CA200R-M14	2533530	CB3662L	2870229	CL1/0-D14	2396360	CL4/0-38	2396991	CP1086-W-1000-KV	2597905
CA240-M12	8005594	CB9630H	2598504	CL1/0-D141	2396361	CL4/0-D141	2396961	CP1096	2597700
CA240-M16	8005596	CBP-F405	2076535	CL1/0-D38	2396370	CL4/0-D38	2396970	CP1096-W-1000-KV	2597695
CA240-M20	8005600	CBP-F408	2076540	CL1/0-DN	2396375	CL4/0-DN	2396975	CP1120	2597962
CA240R-2M14	2533850	CBP-F408P	2076543	CL1/OIH-10	2396405	CL4/0-DN38	2396971	CP1120-W-1000-KV	2597958
CA240R-M14	2533770	CBP-F608	2076545	CL1/OIH-12	2396413	CL4/OIH-12	2397011	CP1131	2610120
CA25-2M12	2530210	CBP-F608P	2076550	CL1/OIH-38	2396411	CL4/OIH-38	2397009	CPE-1	2592751

Type/Code Cross-Reference chart

Type	Code	Type	Code	Type	Code	Type	Code	Type	Code
CPE-1-110	2592752	DB160-11/4	2843750	DR625-16	2389050	ERCH	2596112	ES40-BK	2470482
CPKC7508	2808650	DB160-7/1N	2843705	DR625-20	2389060	ERCH-WH	2596114	ES40-BR	2470462
CPKD108	2808582	DB250-11/1N	2843707	DR6-5	2387910	ES03-BK	2470470	ES40-BU	2470422
CPKD1508	2808587	DB400-11/1N	2843709	DR6-6	2387920	ES03-BR	2470450	ES40-GY	2470442
CPKD2508	2808592	DB40-11/4	2843740	DR6-8	2387930	ES03-BU	2470410	ES40-RE	2470522
CPKD508	2808573	DB40-15/2	2843720	DR70-10	2388330	ES03-GY	2470430	ES40-YE	2470562
CPKD7508	2808578	DB500-11/1N	2843711	DR70-12	2388340	ES03-RE	2470510	ES48-BK	2470483
CPP-0	2592671	DB80-6/1N	2843701	DR70-14	2388350	ES03-YE	2470550	ES48-BR	2470463
CPU1131-C	2610150	DJ160	2843697	DR70-16	2388360	ES06-BK	2470471	ES48-BU	2470423
CPU1230-3D	2630200	DK50-M12	2830080	DR70-20	2388380	ES06-BR	2470451	ES48-GY	2470443
CRP-F305	2076225	DK70-M12	2830082	DR70-8	2388320	ES06-BU	2470411	ES48-RE	2470523
CRP-F308	2076230	DK70-2M12-51AS	2830092	DR95-10	2388395	ES06-GY	2470431	ES48-YE	2470563
CRP-F405	2076235	DK95-M12	2830084	DR95-12	2388400	ES06-RE	2470511	ES5-BK	2470475
CRP-F405P	2076237	DK95-2M12-51AS	2830094	DR95-14	2388410	ES06-YE	2470551	ES5-BR	2470455
CRP-F408	2076240	DK120-M12	2830086	DR95-16	2388420	ES10-BK	2470476	ES5-BU	2470415
CRP-F408P	2076242	DK120-2M12-51AS	2830096	DR95-20	2388430	ES10-BR	2470456	ES5-GY	2470435
CRP-F608	2076245	DNB125-9	2843690	DR95-8	2388390	ES10-BU	2470416	ES5-RE	2470515
CRP-F608P	2076250	DNB160-10	2843692	DSV10	2489015	ES10-GY	2470436	ES5-YE	2470555
CRP-M3	2076010	DR10-10	2388015	DSV1000	2489095	ES10-RE	2470516	ES80-BK	2470484
CRP-M3.5	2076015	DR10-5	2388000	DSV120	2489050	ES10-YE	2470556	ES80-BR	2470464
CRP-M3.5/1	2076020	DR10-6	2388005	DSV150	2489055	ES14-BK	2470477	ES80-BU	2470424
CRP-M4	2076025	DR10-8	2388010	DSV16	2489020	ES14-BR	2470457	ES80-GY	2470444
CRP-M4/3	2076030	DR120-10	2388460	DSV185	2489060	ES14-BU	2470417	ES80-RE	2470524
CRP-M5	2076035	DR120-12	2388470	DSV240	2489065	ES14-GY	2470437	ES80-YE	2470564
CRP-M6	2076040	DR120-16	2388490	DSV25	2489025	ES14-RE	2470517	FD11	3017354
CRP-M6/1	2076045	DR120-20	2388500	DSV300	2489070	ES14-YE	2470557	FD13.5	3017356
CRP-M608	2076260	DR120-8	2388450	DSV35	2489030	ES19-BK	2470478	FD16	3017358
CRP-M7	2076050	DR150-10	2388530	DSV400	2489075	ES19-BR	2470458	FD21	3017360
CRP-M8	2076055	DR150-12	2388540	DSV50	2489035	ES19-BU	2470418	FD29	3017362
CRP-P10	2076155	DR150-16	2388560	DSV500	2489080	ES19-GY	2470438	FD36	3017364
CRP-P12	2076160	DR150-20	2388570	DSV6	2489010	ES19-RE	2470518	FD42	3017366
CRP-P8	2076150	DR16-10	2388050	DSV625	2489085	ES19-YE	2470558	FD48	3017368
CRP-PP12	2076180	DR16-12	2388060	DSV70	2489040	ES1-BK	2470472	FD7	3017350
CRP-PP12/1	2076185	DR16-6	2388030	DSV800	2489090	ES1-BR	2470452	FD9	3017352
CRP-PP12/23	2076190	DR16-8	2388040	DSV95	2489045	ES1-BU	2470412	FDM12	3017375
CRP-PP14	2076195	DR185-10	2388600	DSVA1000	8016417	ES1-GY	2470432	FDM16	3017374
CRP-PP130	2076205	DR185-12	2388610	DSVA120	8016406	ES1-RE	2470512	FDM20	3017377
CRP-U3	2076080	DR185-16	2388620	DSVA150	8016407	ES1-YE	2470552	FDM25	3017379
CRP-U3.5	2076085	DR240-10	2388710	DSVA16	8016400	ES24-BK	2470479	FDM32	3017381
CRP-U3.5/2	2076090	DR240-12	2388720	DSVA185	8016408	ES24-BR	2470459	FDM40	3017383
CRP-U4	2076095	DR240-16	2388730	DSVA240	8016409	ES24-BU	2470419	FDM50	3017385
CRP-U4/1	2076100	DR240-20	2388740	DSVA25	8016401	ES24-GY	2470439	FDM63	3017387
CRP-U4/2	2076105	DR25-10	2388130	DSVA300	8016410	ES24-RE	2470519	FL10-150	2510070
CRP-U5	2076110	DR25-12	2388140	DSVA35	8016402	ES24-YE	2470559	FL10-150-ST	2518510
CRP-U6	2076115	DR25-16	2388160	DSVA400	8016411	ES2-BK	2470473	FL10-200	2510150
CRP-U6/1	2076120	DR25-6	2388110	DSVA401	8016413	ES2-BR	2470453	FL10-200-ST	2518550
CRP-U8	2076125	DR25-8	2388120	DSVA50	8016403	ES2-BU	2470413	FL10-250	2510190
CS-CPE-1	2592748	DR300-10	2388780	DSVA500	8016412	ES2-GY	2470433	FL10-250-ST	2518590
CVB-001	2593300	DR300-12	2388790	DSVA501	8016414	ES2-RE	2470513	FL16-150	2510470
CVB-007	2593295	DR300-16	2388810	DSVA625	8016415	ES2-YE	2470553	FL16-150-ST	2518870
CVB-010	2593298	DR300-20	2388820	DSVA70	8016404	ES30-BK	2470480	FL16-200	2510550
CVB-011	2593299	DR35-10	2388230	DSVA800	8016416	ES30-BR	2470460	FL16-200-ST	2518910
CVB-013	2593294	DR35-12	2388240	DSVA95	8016405	ES30-BU	2470420	FL16-250	2510590
CVB-031	2593312	DR35-16	2388246	ECW-H3D	2630073	ES30-GY	2470440	FL16-250-ST	2518950
CVB-037	2593315	DR35-6	2388210	EK100	2597990	ES30-RE	2470520	FL16-320	2510670
DB100-13/2	2843724	DR35-8	2388220	EK500P	2597992	ES30-YE	2470560	FL16-320-ST	2518990
DB100-13/4	2843744	DR400-12	2388870	EKLOEPA12	2847000	ES37-BK	2470481	FL16-350	2510690
DB100-6/2	2843722	DR400-16	2388890	EKLOS	2848001	ES37-BR	2470461	FL16-350-ST	2519030
DB100-6/4	2843742	DR400-20	2388900	EKL1BEPA12	2847002	ES37-BU	2470421	FL16-420	2510710
DB125-10/4	2843747	DR500-12	2388950	EKL15	2848003	ES37-GY	2470441	FL16-420-ST	2519070
DB125-10/4C	2843787	DR500-16	2388970	EKL2EPA12	2847004	ES37-RE	2470521	FL16-570	2510750
DB125-14/2	2843726	DR500-20	2388980	EKL2S	2848010	ES37-YE	2470561	FL16-570-ST	2519150
DB125-14/2C	2843782	DR50-10	2388260	EKL3EM4PA12	2847006	ES3-BK	2470474	FL16-660	2510790
DB125-14/4	2843748	DR50-12	2388270	EKL3S	2848007	ES3-BR	2470454	FL16-660-ST	2519170
DB125-14/4C	2843788	DR50-14	2388280	EKL4BEPA12	2847009	ES3-BU	2470414	FL25-150	2510950
DB125-6/2	2843725	DR50-16	2388290	EKL4BESVCE	2848009	ES3-GY	2470434	FL25-150-ST	2519530
DB125-6/4	2843746	DR50-6	2388250	ELB-3	2598422	ES3-RE	2470514	FL25-200	2511070
DB125-7/1N	2843703	DR50-8	2388255	EPB-1N	2598453	ES3-YE	2470554	FL25-200-ST	2519570

Type/Code Cross-Reference chart

Type	Code	Type	Code	Type	Code	Type	Code	Type	Code
FL25-250	2511110	G250X4.8N	3041806	GF-M12	2054330	GN-PP12	2155330	GXAC680X7.9	3042358
FL25-250-ST	2519610	G250X4.8N/M	3041808	GF-M14	2054370	GN-PP17	2155370	GXAC840X4.6	3042326
FL25-300	2511190	G250X7.6	3041855	GF-M16	2054410	GN-U10	2154850	GXAC840X7.9	3042360
FL25-300-ST	2519690	G250X7.6N	3041856	GF-M3	2054010	GN-U10/1	2154890	H120-H120	2490914
FLS3	3026810	G280X4.8	3041810	GF-M3.5	2054030	GN-U12	2154930	H120-H120ST	2490915
FLS5	3026815	G280X4.8N	3041811	GF-M4	2054070	GN-U14	2154970	H70-H70	2490910
G100X2.5	3041710	G300X2.8	3041740	GF-M5	2054110	GN-U16	2155010	H70-H70ST	2490911
G100X2.5/M	3041712	G300X2.8N	3041741	GF-M6	2054150	GN-U3.5	2154650	H95-H95	2490912
G100X2.5N	3041711	G300X3.6	3041775	GF-M6/1	2054160	GN-U4	2154690	H95-H95ST	2490913
G100X2.5N/M	3041713	G300X3.6/M	3041777	GF-M608	2055670	GN-U5	2154730	HB10	2591337
G1020X9.0	3041910	G300X3.6N	3041776	GF-M7	2054170	GN-U6	2154770	HB11	2591343
G1020X9.0N	3041911	G300X3.6N/M	3041778	GF-M8	2054210	GN-U8	2154810	HB12N	2591345
G1030X12.6	3041950	G300X4.8	3041815	GF-M8/1	2054220	GP-M10	2046645	HB13UE	2591347
G1030X12.6N	3041951	G300X4.8N	3041816	GF-P10	2055310	GP-M10/1	2046646	HB2	2591308
G120X2.5	3041715	G300X7.6	3041860	GF-P12	2055350	GP-M12	2046650	HB5	2591318
G120X2.5N	3041716	G300X7.6N	3041861	GF-P14	2055370	GP-M14	2046655	HB6	2591285
G120X3.6	3041745	G370X3.6	3041780	GF-PP12	2055390	GP-M16	2046660	HB7	2591310
G120X3.6N	3041746	G370X3.6N	3041781	GF-PP17	2055430	GP-M3	2046610	HB8	2591284
G120X4.8	3041785	G370X4.8	3041820	GF-PPL46	2055465	GP-M3.5	2046615	HB9	2591336
G120X4.8N	3041786	G370X4.8N	3041821	GF-U10	2054810	GP-M4	2046620	HF1	2590900
G1220X9.0	3041915	G370X7.6	3041865	GF-U10/1	2054850	GP-M5	2046625	HF2	2590905
G1220X9.0N	3041916	G370X7.6N	3041866	GF-U12	2054890	GP-M6	2046630	HN1	2590300
G140X2.5	3041720	G380X12.6	3041925	GF-U14	2054930	GP-M6/1	2046631	HN5	2590291
G140X2.5/M	3041722	G390X4.8	3041825	GF-U16	2054970	GP-M7	2046635	HN-A25	2590401
G140X2.5N	3041721	G390X4.8N	3041826	GF-U3.5	2054610	GP-M8	2046640	HN-D25	2590403
G140X2.5N/M	3041723	G430X4.8	3041830	GF-U4	2054650	GP-M8/1	2046641	HN-H25	2590405
G140X3.6	3041750	G430X4.8N	3041831	GF-U5	2054690	GP-P10	2046715	HNKE16	2590329
G140X3.6/M	3041753	G430X7.6	3041870	GF-U6	2054730	GP-P12	2046720	HNKE4	2590299
G140X3.6N	3041751	G430X7.6N	3041871	GF-U8	2054770	GP-P14	2046725	HNKE50	2590342
G140X3.6N/M	3041752	G430X9.0	3041880	GH8	3041550	GP-PP12	2046740	HNN3	2590296
G150X3.6	3041755	G430X9.0N	3041881	GK-F608	2145500	GP-PP17	2046750	HNN4	2590292
G150X3.6N	3041756	G450X4.8	3041835	GK-F608P	2145502	GP-PPL46	2046755	HN-T25	2590407
G150X7.6	3041845	G450X4.8N	3041836	GKF-M608	2055672	GP-U10	2046865	HP1	2590500
G150X7.6N	3041846	G480X12.6	3041930	GKY-M10	2145997	GP-U10/1	2046866	HP3	2590531
G160X2.5	3041725	G480X12.6N	3041931	GKY-M12	2146000	GP-U12	2046870	HP4-B	2590032
G160X2.5/M	3041727	G530X4.8	3041840	GKY-M14	2146003	GP-U14	2046875	HP4-C10	2590040
G160X2.5N	3041726	G530X4.8N	3041841	GKY-M16	2146006	GP-U16	2046880	HP4-G	2590033
G160X2.5N/M	3041728	G530X7.6	3041875	GKY-M3.5	2145982	GP-U3.5	2046825	HP4-R	2590031
G160X4.8	3041790	G530X7.6N	3041876	GKY-M4	2145985	GP-U4	2046830	HPH1	2590029
G160X4.8N	3041791	G530X9.0	3041885	GKY-M5	2145988	GP-U5	2046845	HR10-10	2385035
G180X3.6	3041760	G530X9.0N	3041886	GKY-M6	2145991	GP-U6	2046855	HR10-12	2385040
G180X3.6N	3041761	G580X12.6	3041935	GKY-M8	2145994	GP-U8	2046860	HR10-6	2385025
G190X4.8	3041795	G580X12.6N	3041936	GKY-P14	2146040	GR100X7.6N	3042620	HR10-8	2385030
G190X4.8/M	3041797	G710X9.0	3041890	GKY-PP12	2146045	GR120X7.6N	3042625	HR120-10	2385245
G190X4.8N	3041796	G710X9.0N	3041891	GKY-PP17	2146047	GR150X7.6N	3042630	HR120-12	2385250
G190X4.8N/M	3041798	G730X12.6	3041940	GKY-PPL46	2146055	GR200X7.6N	3042635	HR120-14	2385255
G200X2.5	3041730	G730X12.6N	3041941	GKY-U3.5	2146020	GR250X7.6N	3042640	HR120-16	2385260
G200X2.5/M	3041732	G780X9.0	3041895	GKY-U4	2146023	GR300X7.6N	3042645	HR120-20	2385265
G200X2.5N	3041731	G780X9.0N	3041896	GKY-U5	2146026	GR370X7.6N	3042650	HR120-8	2385240
G200X2.5N/M	3041733	G80X2.4	3041700	GKY-U6	2146029	GX1020X7.9	3042270	HR150-10	2385275
G200X3.6	3041765	G80X2.4/M	3041702	GKY-U8	2146032	GX200X4.5	3042245	HR150-12	2385280
G200X3.6/M	3041767	G80X2.4N	3041701	GN-M10	2154250	GX300X4.5	3042250	HR150-14	2385285
G200X3.6N	3041766	G80X2.4N/M	3041703	GN-M10/1	2154290	GX370X4.5	3042255	HR150-16	2385290
G200X3.6N/M	3041768	G830X9.0	3041900	GN-M12	2154330	GX370X7.9	3042260	HR150-20	2385295
G200X4.8	3041800	G830X9.0N	3041901	GN-M14	2154370	GX520X4.5	3042257	HR150-8	2385270
G200X4.8/M	3041802	G880X12.6	3041945	GN-M16	2154410	GX680X7.9	3042265	HR16-10	2385060
G200X4.8N	3041801	G880X12.6N	3041946	GN-M3	2154010	GXAC125X4.6	3042310	HR16-12	2385065
G200X4.8N/M	3041803	G90X2.4	3041705	GN-M3.5	2154030	GXAC150X4.6	3042312	HR16-5	2385047
G200X7.6	3041850	G90X2.4N	3041706	GN-M4	2154070	GXAC200X4.6	3042314	HR16-6	2385050
G200X7.6N	3041851	G920X9.0	3041905	GN-M5	2154110	GXAC200X7.9	3042350	HR16-8	2385055
G230X12.6	3041920	G920X9.0N	3041906	GN-M6	2154150	GXAC260X4.6	3042316	HR185-10	2385305
G230X12.6N	3041921	GA-3	2598429	GN-M6/1	2154160	GXAC290X4.6	3042318	HR185-12	2385310
G250X2.8	3041735	GF-F608	2055630	GN-M7	2154170	GXAC290X7.9	3042352	HR185-14	2385315
G250X2.8N	3041736	GF-F608P	2055650	GN-M8	2154210	GXAC360X4.6	3042320	HR185-16	2385320
G250X3.6	3041770	GFH100X2.5	3042810	GN-M8/1	2154220	GXAC360X7.9	3042354	HR240-10	2385335
G250X3.6N	3041771	GFHT112X2.5	3042805	GN-P10	2155250	GXAC520X4.6	3042322	HR240-12	2385340
G250X4.8	3041805	GF-M10	2054250	GN-P12	2155290	GXAC520X7.9	3042356	HR240-14	2385345
G250X4.8/M	3041807	GF-M10/1	2054290	GN-P14	2155310	GXAC680X4.6	3042324	HR240-16	2385350

Type/Code Cross-Reference chart

Type	Code	Type	Code	Type	Code	Type	Code	Type	Code
HR240-20	2385355	KE0.75-1	2591050	L185-T	2486910	M158	2651200	M75SH-600	2649279
HR25-10	2385085	KE10-1	2591049	L19-M	2480490	M158-50	2675880	M76.15H-600	2649283
HR25-12	2385090	KE1016ST	2803150	L19-P	2485430	M158-C	2612130	M76AH-1000	2649592
HR25-14	2385095	KE106ST	2802310	L1-M	2480090	M15CD-1000	2649526	M76AH-600	2649257
HR25-6	2385075	KE110ST	2802390	L1-P	2485070	M15CD-600	2649221	M76SH-1000	2649562
HR25-8	2385080	KE1508ST	2802510	L200-M	2481090	M160-520	2648771	M76SH-600	2649281
HR35-10	2385115	KE1510ST	2802550	L240-T	2486920	M16CD-1000	2649528	M7CD-1000	2649510
HR35-12	2385120	KE16-15	2599861	L24-M	2480570	M16CD-600	2649223	M7CD-600	2649205
HR35-14	2385125	KE1616ST	2803190	L24-P	2485510	M16SH-1000	2649556	M8CD-1000	2649512
HR35-16	2385130	KE1A-3	2598430	L25-T	2486840	M16SH-600	2649271	M8CD-600	2649207
HR35-6	2385105	KE2.5-1	2591048	L2-M	2480130	M173	2651210	M96	2651110
HR35-8	2385110	KE2.5A-3	2598432	L2-P	2485100	M173-50	2675890	M96-50	2675850
HR50-10	2385150	KE25015ST	2803455	L300-T	2486930	M173-C	2612230	M96-C	2611800
HR50-12	2385155	KE25018ST	2803460	L30-M	2480650	M173L-C	2612240	M9CD-1000	2649514
HR50-14	2385160	KE2508ST	2802670	L30-P	2485590	M17CD-1000	2649530	M9CD-600	2649209
HR50-16	2385165	KE2510ST	2802710	L35-T	2486850	M17CD-600	2649225	MA03/3-15	2599870
HR50-6	2385140	KE35015ST	2803475	L37-M	2480730	M18CD-1000	2649532	MA1	2650110
HR50-8	2385145	KE35018ST	2803480	L37-P	2485670	M18SH-1000	2649558	MA10	2650190
HR70-10	2385185	KE35-15	2599862	L3-M	2480170	M18SH-600	2649273	MA10.19-U	2600290
HR70-12	2385190	KE410ST	2802870	L3-P	2485130	M190-50	2675900	MA100-3D	2631790
HR70-14	2385195	KE412ST	2802910	L400-T	2486940	M190-520	2648772	MA100-520	2645690
HR70-16	2385200	KE4-15	2599860	L48-M	2480810	M190-C	2612330	MA10-50	2675666
HR70-6	2385175	KE506ST	2802030	L48-P	2485680	M19CD-1000	2649534	MA10-C	2610860
HR70-8	2385180	KE508ST	2802070	L4-T	2486805	M208-C	2612420	MA12.20-U	2600310
HR95-10	2385215	KE610ST	2802990	L50-T	2486860	M208-U	2603780	MA120-3D	2631810
HR95-12	2385220	KE612ST	2803030	L5-M	2480210	M20AH-1000	2649570	MA120-520	2645711
HR95-14	2385225	KE616ST	2803070	L5-P	2485160	M20AH-600	2649235	MA12-50	2675668
HR95-16	2385230	KE7506ST	2802110	L60-M	2480850	M20CD-1000	2649536	MA12-C	2610870
HR95-20	2385235	KE7508ST	2802150	L60-P	2485690	M20SH-1000	2649560	MA14-50	2675670
HR95-8	2385210	KIT-2.5-EPB1N	2598463	L6-T	2486810	M20SH-600	2649275	MA14-C	2610880
HSV10	2488015	KIT-4-EPB1N	2598464	L70-T	2675910	M215-50	2675910	MA1-50	2675658
HSV120	2488050	KIT-B1300-C-1	2599318	L7-M	2480250	M215-520	2648773	MA160-520	2645731
HSV150	2488055	KIT-B1300-C-2	2599319	L7-P	2485190	M215-C	2612490	MA17-50	2675672
HSV16	2488020	KIT-B1300-C-MK	2599349	L80-M	2480890	M220-520	2648774	MA17-C	2610890
HSV185	2488060	KIT-B500-1	2596201	L95-T	2486880	M232-C	2612590	MA19-50	2675674
HSV240	2488065	KIT-B500-2	2596202	M108.215-U	2603723	M24AH-1000	2649572	MA19-C	2610900
HSV25	2488025	KIT-B500-MK	2596203	M108-520	2648752	M24AH-600	2649237	MA19-U	2600320
HSV35	2488030	KIT-B500ND-1	2596225	M108-C	2611860	M255-520	2648776	MA2.3	2650130
HSV50	2488035	KIT-B-FL750-1	2598860	M10CD-1000	2649516	M27AH-1000	2649574	MA2.3-50	2675660
HSV70	2488040	KIT-HT131-C-1	2610380	M10CD-600	2649211	M27AH-600	2649239	MA200-520	2645750
HSV95	2488045	KIT-HT131-C-2	2610381	M10SH-1000	2649550	M295-520	2648780	MA20-50	2675675
HT120	2610420	KIT-HT131-C-MK	2610382	M10SH-600	2649265	M30AH-1000	2649576	MA20-C	2610910
HT120-KV	2610430	KIT-HT51-1	2670601	M110-520	2648754	M30AH-600	2649241	MA24-50	2675676
HT131-C	2610416	KIT-HT51-2	2670600	M113	2651130	M340-520	2648784	MA24-C	2610920
HT131LN-C	2610419	KIT-HT51-MK	2670599	M113.173-U	2603730	M34AH-1000	2649578	MA24-U	2600330
HT131-UC	2610436	KIT-HT-FL75-1	2665031	M113-50	2675855	M34AH-600	2649243	MA29-80-U	2600360
HT45-E	2650040	KIT-HWE1	8420012	M113-C	2611870	M36AH-1000	2649580	MA29-C	2610930
HT51	2670610	KT1	2591319	M118	2651150	M36AH-600	2649245	MA2-C	2610810
HT51-KV	2670611	KT2	2591320	M118.158-U	2603725	M38AH-1000	2649582	MA3.5-U	2600210
HT60C	2670205	KT3N	2591276	M118-50	2675860	M38AH-600	2649247	MA30-80-U	2600380
HT61	2670235	KT4N	2591278	M118-C	2611910	M40AH-1000	2649584	MA30-C	2610940
HT81-U	2600036	KT5	2591279	M11CD-1000	2649518	M40AH-600	2649249	MA35-C	2610950
HT-FL74	2665028	KTS1632	2590700	M11CD-600	2649213	M42AH-1000	2649586	MA35-U	2600390
HT-FL75	2665030	L03-M	2480020	M12CD-1000	2649520	M440-520	2648840	MA37-C	2610960
HT-TC026	2591406	L03-P	2485010	M12CD-600	2649215	M44AH-1000	2649588	MA37-U	2600410
HT-TC026Y	2591408	L06-M	2480050	M12SH-1000	2649552	M48AH-1000	2649590	MA3-C	2610820
HT-TC041N	2591427	L06-P	2485040	M12SH-600	2649267	M540-520	2648910	MA40-C	2610970
HT-TC051	2591472	L100-M	2480930	M13CD-1000	2649522	M70	2651090	MA40-U	2600430
HT-TC051Y	2591475	L10-M	2480330	M13CD-600	2649217	M70.140-U	2603710	MA48-C	2610980
HT-TC055	2591445	L10-P	2485270	M140	2651170	M70-50	2675800	MA48-U	2600450
HT-TC065	2591477	L10-T	2486820	M140.190-U	2603800	M70-C	2611590	MA5	2650150
HT-TC0851	2591496	L120-M	2481010	M140-50	2675870	M74AH-600	2649253	MA5-50	2675662
HWE1	8420009	L120-T	2486890	M140-C	2612010	M74SH-600	2649277	MA5-C	2610830
HX1	2590298	L14-M	2480410	M145-520	2648770	M75	2651100	MA60-C	2610990
I38-F	6060130	L14-P	2485350	M14CD-1000	2649524	M75.96-U	2603715	MA7	2650170
I38-MS	6060128	L150-T	2486900	M14CD-600	2649219	M75-50	2675805	MA7.14-U	2600250
IDT	2590920	L160-M	2481050	M14SH-1000	2649554	M75AH-600	2649255	MA7-50	2675664
IT6	8420016	L16-T	2486830	M14SH-600	2649269	M75-C	2611650	MA7-C	2610840

Type/Code Cross-Reference chart

Type	Code	Type	Code	Type	Code	Type	Code	Type	Code
MA80-3D	2631770	ME19-50	2676100	MH16-50	2675220	MK34-C	2614370	MN30RF-C	2610784
MA80-520	2645671	ME19-C	2614219	MH16-C	2614173	MK34L-C	2614371	MN35-C	2610635
MA9	2650180	ME2	2652030	MH185-50	2675300	MK38-3D	2634830	MN35F-C	2610786
MA9.17-U	2600270	ME2.19-U	2604750	MH185-C	2614189	MK42-3D	2634850	MN37-C	2610640
MA9-50	2675665	ME2/3-15	2599876	MH240-50	2675310	MK44-3D	2634870	MN37RF-C	2610788
MA9-C	2610850	ME20	2652230	MH240-C	2614191	MK46-3D	2634880	MN3-C	2610520
MB2-80-U	2604350	ME200-520	2648558	MH25-50	2675230	MK5	2651575	MN3RF-50	2676220
MB3-80-U	2604400	ME20-50	2676110	MH25-C	2614175	MK5/8-15	2599890	MN3RF-C	2610762
MBS50-240C	2777030	ME20-C	2614221	MH300-50	2675315	MK5-50	2675360	MN48-C	2610650
MC0	2650490	ME24	2652250	MH300-C	2614193	MK5-C	2614249	MN48RF-C	2610790
MC0.2-U	2603550	ME24-50	2676120	MH35-50	2675240	MK6	2651580	MN5-C	2610530
MC0-U	2603510	ME24-C	2614223	MH35-C	2614177	MK6-50	2675370	MNSRF-50	2676230
MC10	2650530	ME24L	2652251	MH400-C	2614195	MK6-C	2614250	MNSRF-C	2610764
MC10-50	2675610	ME2-50	2676010	MH50-50	2675250	MK7-C	2614254	MN60-C	2610660
MC10-C	2611100	ME29	2652260	MH50-C	2614179	MK8	2651610	MN7-C	2610540
MC10-U	2600610	ME29-50	2676130	MH70-50	2675260	MK8-50	2675390	MN7RF-50	2676240
MC185-3D	2632030	ME29-C	2614225	MH70-C	2614181	MK8-C	2614260	MN7RF-C	2610766
MC185-C	2611150	ME29-U	2604870	MH95-50	2675270	MK9-C	2614265	MN80-3D	2631450
MC2	2650500	ME2-C	2614201	MH95-C	2614183	ML150-240-12C	2752180	MN9-C	2610551
MC240-3D	2632035	ME3	2652050	MK10	2651640	ML150-240-16C	2752182	MO10-50	2675100
MC25	2650550	ME3.14-U	2604770	MK10-50	2675410	ML95-240-12C	2752175	MO12-50	2675110
MC25-50	2675620	ME30	2652270	MK10-C	2614270	ML95-240-16C	2752177	MO16-50	2675120
MC25-C	2611110	ME30-50	2676140	MK12	2651670	MLA50-240-12C	2752170	MO18-50	2675130
MC25-U	2600650	ME30-C	2614227	MK12-50	2675430	MLL1	2590802	MO20-50	2675140
MC3	8420018	ME30L	2652271	MK12-C	2614280	MLL90	2590812	MO21-50	2675143
MC35	2650570	ME30-U	2604890	MK13-C	2614285	MLRJ1	2590815	MO22-50	2675146
MC35-50	2675630	ME3-50	2676020	MK14	2651700	MLS1	2590805	MO24-50	2675150
MC35-C	2611120	ME35-50	2676150	MK14-3D	2634781	MLS2	2590807	MP608	3031810
MC35-U	2600690	ME35-C	2614229	MK14-50	2675450	MMT200-50	2676388	MP608/45	3031815
MC4	8420019	ME35-U	2604910	MK14-C	2614290	MMT200-C	2611190	MP608/90	3031820
MC6	2650510	ME37-50	2676160	MK15-C	2614295	MMT200-U	2601170	MP608D	3031830
MC6.25-U	2600630	ME37-C	2614231	MK15L-C	2614296	MMT25-50	2676380	MPC1	2595201
MC6-50	2675605	ME37-U	2604930	MK16	2651730	MMT25-C	2611160	MPC2	2595203
MC70-3D	2632010	ME3-C	2614203	MK16-3D	2634783	MMT25-U	2601050	MPC4	2595208
MC70-50	2675640	ME40-50	2676165	MK16-50	2675470	MMT315-C	2611200	MPC7	2595221
MC70-80-U	2600720	ME40-C	2614233	MK16-C	2614300	MMT50-50	2676382	MQ10-50	2675010
MC70-C	2611130	ME40-U	2604950	MK17-C	2614305	MMT50-C	2611170	MQ16-50	2675013
MC95-3D	2632020	ME48-50	2676170	MK175-C	2614307	MMT50-U	2601090	MQ25-50	2675016
MC95-80-U	2600730	ME48-C	2614235	MK18	2651750	MMT95-50	2676384	MQ35-50	2675019
MC95-C	2611140	ME48-U	2604970	MK18-3D	2634785	MMT95-C	2611180	MQ50-50	2675021
MCCC16-C	2617050	ME5	2652070	MK18-50	2675490	MMT95-U	2601130	MQ70-50	2675024
MCCC25-C	2617070	ME5.7-U	2604790	MK18-C	2614310	MN10-C	2610560	MQM10-C	2610661
MCCC35-C	2617090	ME5-50	2676030	MK19-C	2614315	MN10RF-50	2676250	MQM120-C	2610668
MCCC50-C	2617110	ME5-C	2614205	MK20	2651770	MN10RF-C	2610768	MQM150-C	2610669
MCS4-15	2599868	ME60-50	2676172	MK20-3D	2634786	MN12-C	2610570	MQM16-C	2610662
ME03/2-15	2599875	ME60-C	2614237	MK20-50	2675510	MN12F-50	2676260	MQM185-C	2610670
ME1	2652010	ME7	2652090	MK20-C	2614320	MN12F-C	2610770	MQM240-C	2610671
ME10	2652130	ME7-50	2676040	MK21-C	2614325	MN14-C	2610580	MQM25-C	2610663
ME10.24-U	2604830	ME7-C	2614207	MK22-3D	2634787	MN14RF-50	2676270	MQM35-C	2610664
ME100-3D	2634940	ME80-3D	2634930	MK22-50	2675530	MN14RF-C	2610772	MQM50-C	2610665
ME100-520	2648552	ME80-520	2648550	MK22-C	2614330	MN17-C	2610591	MQM70-C	2610666
ME10-50	2676060	ME80-C	2614239	MK22L	2651791	MN17F-50	2676280	MQM95-C	2610667
ME10-C	2614211	ME9	2652110	MK22L-50	2675534	MN17F-C	2610774	MQS150-C	2610755
ME12	2652150	ME9.20-U	2604810	MK23-C	2614335	MN19-C	2610600	MQS16-C	2610752
ME12.17-U	2604850	ME9-50	2676050	MK25-3D	2634788	MN19RF-50	2676285	MQS240-C	2610756
ME120-3D	2634950	ME9-C	2614209	MK25-50	2675550	MN19RF-C	2610776	MQS35-C	2610753
ME120-520	2648554	MFB13-40	2598040	MK25-C	2614340	MN20-C	2610610	MQS70-C	2610754
ME12-50	2676070	MFB50-63	2598045	MK28-3D	2634790	MN20F-50	2676290	MRD22-C	2616950
ME12-C	2614213	MH10/16-15	2599886	MK28-50	2675560	MN20F-C	2610778	MRD24-C	2616952
ME14	2652170	MH10-50	2675210	MK28-C	2614350	MN24-C	2610620	MRD29-C	2616954
ME14-50	2676080	MH10-C	2614171	MK28L-C	2614351	MN24RF-50	2676295	MRD32-C	2616956
ME14-C	2614215	MH120-50	2675280	MK30-C	2614355	MN24RF-C	2610780	MRH22-50	2675085
ME1-50	2676005	MH120-C	2614185	MK30L-C	2614356	MN29-C	2610625	MRH26-C	2616802
ME160-520	2648556	MH120L-50	2675281	MK32-3D	2634800	MN29F-C	2610782	MRH30-C	2616804
ME17	2652190	MH150-50	2675290	MK32-50	2675564	MN2-C	2610511	MRH32-C	2616806
ME17-50	2676090	MH150-C	2614187	MK32-C	2614360	MN2RF-50	2676210	MS10	2652515
ME17-C	2614217	MH150L	2654381	MK32L-C	2614361	MN2RF-C	2610760	MS10/16-15	2599881
ME19	2652210	MH150L-50	2675291	MK34-3D	2634810	MN30-C	2610630	MS10-50	2676830

Type/Code Cross-Reference chart

Type	Code	Type	Code	Type	Code	Type	Code	Type	Code
MS120	2652550	MT25-TD	2540150	MT-FC48N	2685903	MUA35	2616010	MUT9985-50	2676495
MS120-50	2676900	MT300-C16	8006298	MTMA10-GC	2720025	MUA95	2616030	MUT9985-C	2613057
MS150	2652555	MT300-GC	8006190	MTMA120/1	2720280	MUT9914-C	2612995	MUT9985-W	2664335
MS150-50	2676910	MT300-TD	8006090	MTMA120-70-GC	2721410	MUT9915-C	2612996	MUT9986	2654486
MS150L	2652556	MT315R-C16	2545950	MTMA120-95-GC	2721450	MUT9916-C	2612997	MUT9986-50	2676616
MS150L-50	2676911	MT315R-GC	2542150	MTMA120-GC	2720272	MUT9917-C	2612998	MUT9986-C	2613058
MS16	2652520	MT315R-TD	2540750	MTMA150/1	2720320	MUT9918-C	2612999	MUT9986-W	2664329
MS16-25-U	2605355	MT315S-C16	2545990	MTMA150-120-GC	2721630	MUT9919-C	2613001	MUT9987	2654487
MS16-50	2676840	MT315S-GC	2542290	MTMA150-70-GC	2721550	MUT9920-C	2613002	MUT9987-50	2676617
MS185-50	2676920	MT315S-TD	2540790	MTMA150-95-GC	2721590	MUT9921-C	2613003	MUT9987-C	2613059
MS185-U	2605375	MT35-C10	8006212	MTMA150-GC	2720330	MUT9922-C	2613004	MUT9987-W	2664332
MS240-50	2676925	MT35-C14-80	8006216	MTMA16/1	2720031	MUT9923-C	2613005	MUT9988-50	2676618
MS240-U	2605380	MT35-C8	8006210	MTMA16-10-GC	2720560	MUT9924-C	2613006	MUT9988-C	2613060
MS25	2652525	MT35-GC	8006110	MTMA16-GC	2720035	MUT9925-C	2613007	MUT9988-W	2664331
MS25-50	2676850	MT35-TD	8006010	MTMA185/1	2720370	MUT9926-C	2613008	MUT9989-50	2676500
MS300-50	2676930	MT400-GC	8006195	MTMA185-120-GC	2721900	MUT9927-C	2613009	MUT9989-C	2664333
MS35	2652530	MT400-TD	2540830	MTMA185-150-GC	2721910	MUT9928-C	2613010	MUT9990	2654490
MS35-50	2676860	MT405-C10	2543410	MTMA185-GC	2720360	MUT9929-C	2613011	MUT9990-50	2676620
MS35-50-U	2605360	MT405-C14-80	2546070	MTMA240/1	2720400	MUT9941-50	2676485	MUT9990-C	2613062
MS4/10-15	2599880	MT405-C8	2543400	MTMA240-150-GC	2722050	MUT9941-C	2613015	MUT9990-W	2664334
MS50	2652535	MT405-GC	2541610	MTMA240-185-GC	2722090	MUT9941-W	2664319	MUT9991	2654491
MS50-50	2676870	MT405-TD	2540190	MTMA240-GC	2720410	MUT9942-W	2664320	MUT9991-50	2676590
MS6	2652510	MT500-TD	2540870	MTMA25/1	2720071	MUT9943-50	2676490	MUT9991-C	2613063
MS6-10-U	2605350	MT50-C10	8006222	MTMA25-10-GC	2720575	MUT9943-W	2664321	MUT9991-W	2664336
MS6-50	2676820	MT50-C14-80	8006226	MTMA25-16-GC	2720580	MUT9950-C	2613020	MUT9993	2654493
MS70	2652540	MT50-C8	8006220	MTMA25-GC	2720090	MUT9954-50	2676480	MUT9993-50	2676610
MS70-150-U	2605365	MT50-GC	8006120	MTMA300-GC	2720430	MUT9954-W	2664322	MUT9993-C	2613065
MS70-50	2676880	MT50R-C10	2543650	MTMA35/1	2720111	MUT9955-C	2613025	MUT9993-W	2664338
MS95	2652545	MT50R-C8	2543610	MTMA35-20-GC	2720135	MUT9956-C	2613026	MUT9995	2654495
MS95-120-U	2605370	MT50R-GC	2541690	MTMA35-GC	2720130	MUT9957-C	2613027	MUT9995-50	2676545
MS95-50	2676890	MT50R-TD	2540270	MTMA400/1	2720475	MUT9958-C	2613028	MUT9995-C	2613070
MT120-C12	8006254	MT50S-C10	2543850	MTMA400-240-GC	2722245	MUT9958-W	2664324	MUT9995-W	2664340
MT120-C16	8006258	MT50S-C14-80	2546110	MTMA400-300-GC	2722250	MUT9959-C	2613029	MUT9996	2654496
MT120-GC	8006150	MT50S-C8	2543810	MTMA50/1	2720160	MUT9960-C	2613030	MUT9996-50	2676546
MT120-TD	8006050	MT50S-GC	2541650	MTMA500-300-GC	2722260	MUT9961-C	2613032	MUT9996-C	2613080
MT150-C10	8006252	MT50S-TD	2540230	MTMA500-40/1	2720509	MUT9962-C	2613033	MUT9996-W	2664342
MT150-C12	8006264	MT50-TD	8006020	MTMA500-400-GC	2722270	MUT9964-C	2613034	MUT9997	2654497
MT150-C14-80	8006266	MT630-TD	2540890	MTMA500-GC	2720515	MUT9965-C	2613036	MUT9997-50	2676547
MT150-C16	8006268	MT70-C10	8006232	MTMA50-25-GC	2720650	MUT9966-C	2613037	MUT9997-C	2613085
MT150-GC	8006160	MT70-GC	8006130	MTMA50-35-GC	2720660	MUT9967-C	2613038	MUT9997-W	2664344
MT150R-C12	2545010	MT70S-C10	2544050	MTMA50-GC	2720152	MUT9968-C	2613039	MUT9998	2654498
MT150R-C16	2545090	MT70S-GC	2541730	MTMA630/1	2720530	MUT9969-C	2613040	MUT9998-50	2676548
MT150R-GC	2541870	MT70S-TD	2540350	MTMA70/1	2720191	MUT9970-C	2613041	MUT9998-C	2613090
MT150R-TD	2540550	MT70-TD	8006030	MTMA70-35-GC	2720940	MUT9971-C	2613042	MUT9998-W	2664346
MT150S-C12	2545310	MT95-C10	8006242	MTMA70-50-GC	2720980	MUT9972-C	2613043	MUT9999	2654499
MT150S-C14-80	2546270	MT95-C12	8006244	MTMA70-GC	2720195	MUT9973-C	2613044	MUT9999-50	2676550
MT150S-C16	2545350	MT95-C14-80	8006246	MTMA95/1	2720250	MUT9974-C	2613045	MUT9999-C	2613091
MT150S-GC	2541910	MT95-GC	8006140	MTMA95-50-GC	2721030	MUT9975-50	2676614	MUT9999-W	2664348
MT150S-TD	2540630	MT95R-C10	2544290	MTMA95-70-GC	2721070	MUT9975-C	2613046	MV150	2616170
MT150-TD	8006060	MT95R-C12	2544330	MTMA95-GC	2720232	MUT9976-C	2613047	MV230-400-MC5E	2680860
MT185-C10	8006262	MT95R-GC	2541770	MTMAD300/1	2720460	MUT9977-C	2613048	MV230-630-MC6E	2680870
MT185-C16	8006278	MT95R-TD	2540390	MTMAD300-150-GC	2722140	MUT9978-C	2613049	MV240	2616180
MT185-GC	8006170	MT95S-C10	2544530	MTMAD300-185-GC	2722160	MUT9979-C	2613050	MV35	2616150
MT185-TD	8006070	MT95S-C12	2544570	MTMAD300-240-GC	2722220	MUT9980-50	2676540	MV95	2616160
MT200R-C10	2545540	MT95S-C14-80	2546230	MTMAD300-95-GC	2722121	MUT9980-C	2613052	MVM150	2616310
MT200R-C16	2545550	MT95S-GC	2541850	MTMAD300-GC	2720440	MUT9980-W	2664326	MVM230-400-MJ5E	2680910
MT200R-GC	2542030	MT95S-TD	2540470	MTT120-50	2677275	MUT9981-50	2676611	MVM230-630-MJ6E	2680920
MT200R-TD	2540670	MT95-TD	8006040	MTT16-50	2677220	MUT9981-C	2613053	MVM240	2616320
MT240-C12	8006284	MTA120-C	2771510	MTT25-50	2677230	MUT9982-50	2676612	MVM35	2616290
MT240-C16	8006288	MTA150-C	2771710	MTT35-50	2677240	MUT9982-C	2613054	MVM95	2616300
MT240-GC	8006180	MTA16-C	2770001	MTT50-50	2677250	MUT9982-W	2664327	MY10-50	2677340
MT240R-C12	2545710	MTA185-C	2772150	MTT70-50	2677260	MUT9983	2654483	MY10-C	2613380
MT240R-C16	2545750	MTA240-C	2773010	MTT95-50	2677270	MUT9983-50	2676613	MY14-50	2677345
MT240R-GC	2542110	MTA25-C	2770020	MUA150	2616050	MUT9983-C	2613055	MY14-C	2613385
MT240R-TD	2540710	MTA35-C	2770030	MUA230-630-400	2680129	MUT9983-W	2664328	MY16-50	2677350
MT240-TD	8006080	MTA50-C	2770310	MUA230-630-630	2680130	MUT9984-50	2675621	MY16-C	2613390
MT25-C8	2543030	MTA70-C	2770550	MUA240	2616070	MUT9984-C	2613056	MY19-50	2677355
MT25-GC	2541570	MTA95-C	2770830	MUA300-34	2616090	MUT9984-W	2664330	MY19-C	2613395

Type/Code Cross-Reference chart

Type	Code	Type	Code	Type	Code	Type	Code	Type	Code
MY24-50	2677360	PA60-C	2611040	PKD7510	2808864	PS130-35/E	2616351	RD15.55S	2685560
MY24-C	2613400	PB-1	2591046	PKD7512	2808866	PS130-95/E	2616361	RD15.55S-FC	2685550
MY24L-50	2677362	PC1	2590705	PKE1012	2809190	PS230-400-5E	2680186	RD16.25S	2685562
MY2-50	2677310	PG-1	2591047	PKE1018	2809200	PS230-630-6E	2680189	RD16.25S-FC	2685552
MY2-C	2613350	PH1-1	2591061	PKE108	2809090	PV-1	2591044	RD17.55S	2685564
MY30-50	2677365	PKC1012	2809490	PKE1508	2809110	Q10-10	2167025	RD17.55S-FC	2685554
MY30-C	2613405	PKC1018	2809500	PKE1510	2809115	Q10-12	2167030	RD17S5	2685563
MY30L-50	2677366	PKC108	2809390	PKE1518	2809120	Q10-4	2167005	RD18.85S	2685566
MY3-50	2677315	PKC112	2809400	PKE1612	2809210	Q10-5	2167010	RD18.85S-FC	2685556
MY36-50	2677370	PKC120027	2809605	PKE1618	2809220	Q10-6	2167015	RD18D	2685645
MY36-C	2613410	PKC1508	2809410	PKE25016	2809230	Q10-8	2167020	RD18X46	2685654
MY37-50	2677375	PKC1510	2809415	PKE25022	2809240	Q120-10	2167545	RD19.15S	2685568
MY37-C	2613415	PKC1518	2809420	PKE2508	2809130	Q120-12	2167550	RD20.55S	2685570
MY3-C	2613355	PKC1612	2809510	PKE2512	2809135	Q120-16	2167555	RD21.55S	2685571
MY4-50	2677320	PKC1618	2809520	PKE2518	2809140	Q120-8	2167540	RD21X21	2685650
MY48-50	2677380	PKC25016	2809530	PKE308	2809030	Q14-MS	6060120	RD22.65S	2685572
MY48-C	2613420	PKC25022	2809540	PKE410	2809152	Q150-10	2167610	RD224X224	2685678
MY4-C	2613360	PKC2508	2809430	PKE412	2809155	Q150-12	2167615	RD22X30	2685651
MY5-50	2677325	PKC2512	2809435	PKE418	2809160	Q150-16	2167620	RD22X46	2685656
MY5-C	2613365	PKC2518	2809440	PKE508	2809050	Q16-10	2167095	RD23.85S	2685574
MY60-C	2613425	PKC306	2809320	PKE612	2809170	Q16-12	2167100	RD24D	2685647
MY6-50	2677330	PKC308	2809330	PKE618	2809180	Q16-5	2167080	RD25.45S	2685576
MY6-C	2613370	PKC35016	2809550	PKE7508	2809070	Q16-6	2167085	RD27S5	2685578
MY7-50	2677335	PKC35025	2809560	PKT1014	2809870	Q16-8	2167090	RD28.55S	2685580
MY76-C	2613430	PKC410	2809452	PKT108	2809790	Q185-10	2167680	RD28.55S-19	2685584
MY7-C	2613375	PKC412	2809455	PKT110	2809795	Q185-12	2167685	RD29X71	2685655
N11	2581310	PKC418	2809460	PKT1508	2809810	Q185-16	2167690	RD30.55S	2685582
N1-1	2591059	PKC50020	2809570	PKT1512	2809820	Q240-10	2167750	RD30.55S-19	2685586
N12	2581312	PKC50025	2809575	PKT1614	2809880	Q240-12	2167755	RD31.85S	2685588
N13	2581314	PKC508	2809350	PKT2510	2809830	Q240-16	2167760	RD32.55S	2685590
N14	2581316	PKC510	2809360	PKT2512	2809840	Q25-10	2167165	RD34.65S	2685592
N15	2581318	PKC612	2809470	PKT412	2809850	Q25-12	2167170	RD34S5	2685591
N16	2581320	PKC618	2809480	PKT508	2809760	Q25-16	2167175	RD35X65	2685675
ND1	2590080	PKC70022	2809595	PKT510	2809765	Q25-5	2167150	RD36X46	2685658
ND2	2590082	PKC7508	2809370	PKT614	2809860	Q25-6	2167155	RD37.25S	2685594
ND3	2590084	PKC7512	2809380	PKT7508	2809770	Q25-8	2167160	RD37X104	2685674
ND4	2590086	PKC95025	2809600	PKT7510	2809775	Q25-10	2167240	RD37X115	2685661
NIT10	8420017	PKD1012	2808915	PL01-M	2049510	Q35-12	2167245	RD37X54	2685671
NL03-M	2469328	PKD1018	2808917	PL03-M	2051850	Q35-16	2167250	RD37X67	2685672
NL03-P	2110870	PKD106	2808870	PL03-P	2051860	Q35-6	2167230	RD37X88	2685673
NL06-M	2469330	PKD108	2808872	PL06-M	2053850	Q35-8	2167235	RD38.15S	2685596
NL06-P	2111950	PKD110	2808874	PL06-P	2053860	Q38-F	6060126	RD38.55S	2685597
NL06-PB	2111960	PKD112	2808876	PL1-M	2055870	Q38-MS	6060124	RD40.55S	2685598
NL1-M	2469350	PKD1508	2808880	PN14-C	2610710	Q50-10	2167320	RD40.55S-FC	2685627
NL1-P	2113970	PKD1510	2808882	PN24-C	2610720	Q50-12	2167325	RD41.35S	2685600
NL1-PG	2113990	PKD1512	2808884	PN37-C	2610730	Q50-16	2167330	RD41.35S-FC	2685628
NL2-M	2469390	PKD1518	2808886	PN48-C	2610740	Q50-6	2167310	RD42.55S	2685602
NL3-M	2469430	PKD1612	2808920	PN60-C	2610750	Q50-8	2167315	RD42.55S-FC	2685629
NN4-15	2599867	PKD1618	2808922	PN7-C	2610700	Q70-10	2167400	RD43.25S	2685604
NY0	2581324	PKD25016	2808925	PN80-3D	2631460	Q70-12	2167405	RD43.25S-FC	2685630
NY00	2581322	PKD25022	2808927	PNB-1	2591040	Q70-16	2167410	RD44.55S	2685606
NY1	2581326	PKD2508	2808890	PNB-3F/M	2591088	Q70-6	2167390	RD44.55S-FC	2685632
OB2.5P	8420034	PKD2512	2808892	PNB-3N1	2591092	Q70-8	2167395	RD46X107	2685652
PA1	2650230	PKD2518	2808894	PNB-3N5	2591096	Q95-10	2167475	RD46X46	2685660
PA10	2650290	PKD35016	2808930	PNB-3NN3	2591094	Q95-12	2167480	RD46X54	2685662
PA100-3D	2631930	PKD35025	2808932	PNB-3NN4	2591095	Q95-16	2167485	RD46X72	2685664
PA10-50	2675686	PKD410	2808900	PNB-3P	2591090	Q95-8	2167470	RD46X92	2685677
PA10-C	2611010	PKD412	2808902	PNB-3PD	2591091	RA-3	2598428	RD47.25S	2685608
PA120-3D	2631950	PKD418	2808904	PNB-4KE	2591251	RBG-15	2599850	RD47.25S-FC	2685634
PA120-520	2645600	PKD50020	2808935	PNB-6KE	2591260	RBV-15	2599852	RD48.55S	2685609
PA1-50	2675680	PKD50025	2808937	PNB-6KE-T	2591262	RCP-B70	2596116	RD50.55S	2685610
PA19-50	2675694	PKD506	2808850	PNB-7KE	2591268	RD100SS	2685623	RD50X98	2685663
PA200-520	2645610	PKD508	2808852	PNB-7KE-T	2591270	RD102SS	2685636	RD51.45S	2685611
PA24-50	2675696	PKD510	2808854	PO7000	2595904	RD114SS	2685626	RD52.45S	2685613
PA24-C	2611020	PKD612	2808910	PR-1	2591045	RD120SS	2685624	RD54.25S	2685612
PA48-C	2611030	PKD618	2808912	PRCH	2596113	RD126X126	2685669	RD60.55S	2685615
PA5	2650250	PKD7506	2808860	PS130-150/E	2616371	RD138X138	2685670	RD60SS	2685614
PA5-50	2675682	PKD7508	2808862	PS130-240/E	2616381	RD140SS	2685637	RD64SS	2685616

Type/Code Cross-Reference chart

Type	Code	Type	Code	Type	Code	Type	Code	Type	Code
RD65SS	2685618	RH-FC48N	2592596	RN-MA405	3031715	RS1420.21	3008014	S2.5-P8	2163010
RD67X126	2685665	RH-FL75	2592597	RN-MA608	3031720	RS1520.M32	3008058	S2.5-PP12	2163170
RD68X68	2685666	RHM132	2619410	RN-P10	2151270	RS1928.M40	3008060	S2.5-PP12/25	2163210
RD72X136	2685667	RHM50	2670035	RN-P12	2151310	RS2026.29	3008016	S2.5-PP16/25	2163250
RD76.5SS	2685619	RHT160	2592422	RN-P8	2151230	RS2635.36	3008018	S2.5-U10	2162730
RD76SS	2685620	RHT160-60N	2592584	RN-PP12	2151350	RS2735.M50	3008062	S2.5-U12	2162770
RD80.5SS	2685622	RHTD270	2682521	RN-PP12/1	2151370	RT10.5	2592470	S2.5-U3	2162410
RD89SS	2685621	RHTD3241	2682502	RN-PP12/19	2151390	RT11	2592480	S2.5-U3.5	2162450
RD90SS	2685625	RHTD410T	2682520	RN-PP14	2151400	RT13	2592490	S2.5-U3.5/1	2162460
RD92X92	2685668	RHU1000	2640810	RN-PP16/23	2151410	RT13.5	2592495	S2.5-U4	2162490
RF-BF4	2051630	RHU131-C	2619210	RN-U10	2150990	RT14	2592500	S2.5-U4/1	2162510
RF-BM4	2051660	RHU230-630	2680075	RN-U12	2151030	RT15	2592510	S2.5-U4/2	2162530
RF-F305	2051560	RHU450	2640011	RN-U3	2150670	RT17	2592530	S2.5-U5	2162570
RF-F305P	2051565	RHU520	2640151	RN-U3.5	2150710	RT19	2592540	S2.5-U6	2162610
RF-F308	2051580	RHU600	2640250	RN-U3.5/2	2150720	RT21	2592550	S2.5-U6/1	2162650
RF-F308P	2051585	RHU81	2600045	RN-U4	2150750	RT6.5	2592430	S2.5-U8	2162690
RF-F405	2051600	RKF-BF4	2051632	RN-U4/1	2150760	RT8.5	2592450	S6-M10	2163830
RF-F405P	2051605	RKF-BM4	2051662	RN-U4/2	2150790	RT9	2592460	S6-M10/1	2163850
RF-F408	2051590	RKF-F305	2051562	RN-U5	2150830	S1.5-M10	2160390	S6-M12	2163890
RF-F408P	2051595	RKF-F308	2051582	RN-U5/1	2150840	S1.5-M12	2160430	S6-M14	2163930
RF-F608	2051610	RKF-F405	2051602	RN-U6	2150870	S1.5-M2	2160010	S6-M16	2163970
RF-F608P	2051620	RKF-F405P	2051607	RN-U6/1	2150910	S1.5-M3	2160030	S6-M3	2163510
RF-FM608	2051690	RKF-F408	2051592	RN-U8	2150950	S1.5-M3.5	2160070	S6-M3.5	2163550
RF-M10	2050390	RKF-F408P	2051597	RP-M10	2046045	S1.5-M3.5/1	2160110	S6-M4	2163590
RF-M12	2050430	RKF-F608	2051612	RP-M12	2046050	S1.5-M4	2160150	S6-M5	2163630
RF-M2	2050010	RKF-F608P	2051622	RP-M2	2046005	S1.5-M4/3	2160160	S6-M6	2163670
RF-M3	2050030	RKF-FM608	2051692	RP-M3	2046010	S1.5-M5	2160190	S6-M6/1	2163710
RF-M3.5	2050070	RKF-M608	2051652	RP-M3.5	2046015	S1.5-M6	2160230	S6-M7	2163750
RF-M3.5/1	2050110	RKY-M10	2145715	RP-M3.5/1	2046016	S1.5-M6/1	2160270	S6-M8	2163790
RF-M4	2050150	RKY-M12	2145718	RP-M4	2046020	S1.5-M7	2160310	S6-M8/1	2163800
RF-M4/3	2050170	RKY-M3	2145684	RP-M4/3	2046023	S1.5-M8	2160350	S6-P10	2164710
RF-M5	2050190	RKY-M3.5	2145685	RP-M5	2046025	S1.5-P10	2161190	S6-P12	2164750
RF-M6	2050230	RKY-M3.5/1	2145687	RP-M6	2046030	S1.5-P12	2161230	S6-P14	2164790
RF-M6/1	2050270	RKY-M4	2145690	RP-M6/1	2046031	S1.5-P8	2161150	S6-PP12	2164830
RF-M608	2051650	RKY-M5	2145699	RP-M7	2046035	S1.5-PP12	2161310	S6-PP17	2164870
RF-M608P	2051655	RKY-M6/1	2145705	RP-M8	2046040	S1.5-PP12/1	2161330	S6-U10	2164370
RF-M7	2050310	RKY-M8	2145711	RP-P10	2046115	S1.5-PP12/19	2161350	S6-U10/1	2164390
RF-M8	2050350	RKY-P10	2145783	RP-P12	2046120	S1.5-PP14	2161360	S6-U12	2164430
RF-P10	2051250	RKY-P12	2145784	RP-P8	2046110	S1.5-U10	2160950	S6-U14	2164470
RF-P12	2051290	RKY-P8	2145782	RP-PP12	2046140	S1.5-U12	2160990	S6-U16	2164510
RF-P8	2051210	RKY-PP12	2145790	RP-PP12/1	2046145	S1.5-U3	2160630	S6-U3.5	2164170
RF-PP12	2051330	RKY-PP12/19	2145792	RP-PP12/19	2046150	S1.5-U3.5	2160670	S6-U4	2164210
RF-PP12/1	2051340	RKY-PP16/23	2145793	RP-PP12/23	2046155	S1.5-U3.5/2	2160682	S6-U5	2164250
RF-PP12/19	2051370	RKY-PPL30	2145795	RP-PP14	2046160	S1.5-U4	2160710	S6-U6	2164290
RF-PP12/23	2051380	RKY-PPL46	2145798	RP-PP16/23	2046165	S1.5-U4/1	2160730	S6-U8	2164330
RF-PP14	2051410	RKY-U3	2145730	RP-PPL30	2046180	S1.5-U4/2	2160750	SC1	2591261
RF-PP16/23	2051450	RKY-U3.5	2145733	RP-PPL46	2046185	S1.5-U5	2160790	SC3X	2591264
RF-PPL30	2051460	RKY-U4	2145736	RP-U10	2046265	S1.5-U5/1	2160800	SC5X	2591266
RF-PPL46	2051465	RKY-U5	2145739	RP-U12	2046270	S1.5-U6	2160830	SC6X	2591239
RF-U10	2050950	RKY-U6	2145742	RP-U3	2046210	S1.5-U6/1	2160870	SFI10X100X1	2852570
RF-U12	2050990	RKY-U6/1	2145743	RP-U3.5	2046215	S1.5-U8	2160910	SFI10X15.5X0.8	2850970
RF-U3	2050630	RN-FA305	3031610	RP-U3.5/2	2046217	S10-M4	2165130	SFI10X124X1	2851370
RF-U3.5	2050670	RN-FA405	3031615	RP-U4	2046230	S10-M5	2165150	SFI10X32X1	2851570
RF-U3.5/1	2050680	RN-FA608	3031620	RP-U4/1	2046231	S10-M6	2165190	SFI10X40X1	2851770
RF-U3.5/2	2050681	RN-M10	2150430	RP-U4/2	2046240	S10-M7	2165230	SFI10X50X1	2851970
RF-U4	2050710	RN-M12	2150470	RP-U5	2046245	S2.5-M10	2162170	SFI10X63X1	2852170
RF-U4/1	2050730	RN-M2	2150010	RP-U5/1	2046246	S2.5-M12	2162210	SFI10X80X1	2852370
RF-U4/2	2050750	RN-M3	2150030	RP-U6	2046255	S2.5-M3	2161810	SFI12X100X1	2852580
RF-U5	2050790	RN-M3.5	2150070	RP-U6/1	2046256	S2.5-M3.5	2161850	SFI2X13X0.5	2850710
RF-U5/1	2050791	RN-M3.5/1	2150110	RP-U8	2046260	S2.5-M3.5/1	2161890	SFI2X20X1	2851110
RF-U6	2050830	RN-M4	2150150	RS0305.07	3008006	S2.5-M4	2161930	SFI2X24X1	2851310
RF-U6/1	2050870	RN-M4/3	2150170	RS0407.M12	3008050	S2.5-M5	2161970	SFI2X32X1	2851510
RF-U8	2050910	RN-M5	2150190	RS0507.09	3008008	S2.5-M6	2162010	SFI3X13X0.5	2850720
RH50	2670050	RN-M6	2150230	RS0509.M16	3008052	S2.5-M6/1	2162050	SFI3X15.5X0.8	2850920
RH60C	2670216	RN-M6/1	2150270	RS0710.11	3008010	S2.5-M7	2162090	SFI3X20X1	2851120
RH61	2670214	RN-M7	2150350	RS0813.M20	3008054	S2.5-M8	2162130	SFI3X24X1	2851320
RHC131	2619010	RN-M8	2150390	RS1014.16	3008012	S2.5-P10	2163050	SFI3X32X1	2851520
RHC131LN	2619021	RN-MA305	3031710	RS1117.M25	3008056	S2.5-P12	2163090	SFI3X9X0.8	2850520

Type/Code Cross-Reference chart

Type	Code	Type	Code	Type	Code	Type	Code	Type	Code
SFI4X13X0.5	2850730	T185-L10	2381495	TBS127X10WH	2811273	TCP12	3019225	TCS254X50GY	2811587
SFI4X15.5X0.8	2850930	T185-M10	2381450	TBS127X10Y/G	2811172	TCP15	3019230	TCS254X50RE	2811466
SFI4X20X1	2851130	T185-M12	2381460	TBS16X20BK	2811110	TCP18	3019235	TCS254X50TR	2811553
SFI4X24X1	2851330	T185-M14	2381470	TBS16X20BR	2811235	TCP20	3019240	TCS254X50WH	2811496
SFI4X32X1	2851530	T185-M16	2381480	TBS16X20BU	2811185	TCP25	3019250	TCS254X50Y/G	2811527
SFI4X40X1	2851730	T240-M10	2381650	TBS16X20GY	2811210	TCP30	3019260	TCS254X50YE	2811368
SFI4X50X1	2851930	T240-M12	2381660	TBS16X20RE	2811035	TCP35	3019270	TCS320X50BK	2811334
SFI4X80X1	2852330	T240-M14	2381670	TBS16X20WH	2811261	TCP40	3019280	TCS320X50TR	2811554
SFI5X100X1	2852540	T240-M16	2381680	TBS16X20Y/G	2811160	TCP45	3019290	TCS32X200BK	2811318
SFI5X20X1	2851140	T240-M20	2381690	TBS190X5BK	2811124	TCP5	3019210	TCS32X200BR	2811606
SFI5X24X1	2851340	T25-L10	2380470	TBS190X5BR	2811249	TCP50	3019300	TCS32X200BU	2811424
SFI5X32X1	2851540	T25-L6	2380480	TBS190X5BU	2811199	TCP55	3019305	TCS32X200GN	2811394
SFI5X40X1	2851740	T25-L8	2380485	TBS190X5GY	2811224	TCP60	3019310	TCS32X200GY	2811575
SFI5X50X1	2851940	T25-M10	2380450	TBS190X5RE	2811049	TCP65	3019315	TCS32X200RE	2811454
SFI5X63X1	2852140	T25-M12	2380460	TBS190X5WH	2811275	TCP70	3019320	TCS32X200TR	2811540
SFI5X80X1	2852340	T25-M5	2380425	TBS190X5Y/G	2811174	TCS1016X25BK	2811342	TCS32X200WH	2811484
SFI6X13X0.5	2850750	T25-M6	2380430	TBS24X20BK	2811112	TCS1016X25TR	2811558	TCS32X200Y/G	2811515
SFI6X15.5X0.8	2850950	T25-M8	2380440	TBS24X20BR	2811237	TCS1260X25BK	2811344	TCS32X200YE	2811356
SFI6X20X1	2851150	T300-M10	2381750	TBS24X20BU	2811187	TCS1260X25TR	2811559	TCS381X50BK	2811336
SFI6X24X1	2851350	T300-M12	2381760	TBS24X20GY	2811212	TCS127X100BK	2811326	TCS381X50BR	2811620
SFI6X32X1	2851550	T300-M14	2381770	TBS24X20RE	2811037	TCS127X100BR	2811614	TCS381X50BU	2811438
SFI6X40X1	2851750	T300-M16	2381780	TBS24X20WH	2811263	TCS127X100BU	2811432	TCS381X50GY	2811589
SFI6X50X1	2851950	T300-M20	2381790	TBS24X20Y/G	2811162	TCS127X100GN	2811402	TCS381X50TR	2811555
SFI6X63X1	2852150	T35-L10	2380590	TBS254X5BK	2811126	TCS127X100GY	2811583	TCS381X50Y/G	2811511
SFI6X80X1	2852350	T35-L6	2380580	TBS254X5BR	2811251	TCS127X100RE	2811462	TCS48X100BK	2811320
SFI6X90X0.8	2850550	T35-L8	2380585	TBS254X5BU	2811201	TCS127X100TR	2811546	TCS48X100BR	2811608
SFI8X100X1	2852560	T35-M10	2380550	TBS254X5GY	2811226	TCS127X100WH	2811492	TCS48X100BU	2811426
SFI8X24X1	2851360	T35-M12	2380560	TBS254X5RE	2811051	TCS127X100Y/G	2811523	TCS48X100GN	2811396
SFI8X32X1	2851560	T35-M6	2380530	TBS254X5WH	2811277	TCS127X100YE	2811364	TCS48X100GY	2811577
SFI8X40X1	2851760	T35-M8	2380540	TBS254X5Y/G	2811176	TCS12X200BK	2811312	TCS48X100RE	2811456
SFI8X50X1	2851960	T400-M14	2381875	TBS32X10BK	2811114	TCS12X200TR	2811549	TCS48X100TR	2811543
SFI8X63X1	2852160	T400-M16	2381880	TBS32X10BR	2811239	TCS1500X25BK	2811346	TCS48X100WH	2811486
SFI8X80X1	2852360	T400-M20	2381890	TBS32X10BU	2811189	TCS1500X25TR	2811560	TCS48X100Y/G	2811517
SH-B70	2596080	T4-M4	2380060	TBS32X10GY	2811214	TCS160X100BK	2811328	TCS48X100YE	2811358
SS4-8-3.7	3041670	T4-M5	2380070	TBS32X10RE	2811039	TCS160X100TR	2811547	TCS508X25BK	2811338
SS4-8-4.5	3041672	T4-M6	2380080	TBS32X10WH	2811265	TCS16X200BK	2811314	TCS508X25BR	2811622
SS9-4.5	3041675	T50-L10	2380690	TBS32X10Y/G	2811164	TCS16X200BR	2811602	TCS508X25BU	2811440
SS9-5	3041677	T50-L6	2380680	TBS48X10BK	2811116	TCS16X200BU	2811420	TCS508X25GY	2811591
SS9-6.4	3041679	T50-L8	2380685	TBS48X10BR	2811241	TCS16X200GN	2811390	TCS508X25TR	2811556
SUB-D050	8420033	T50-M10	2380650	TBS48X10BU	2811191	TCS16X200GY	2811571	TCS508X25Y/G	2811513
SUB-D075	8420032	T50-M12	2380660	TBS48X10GY	2811216	TCS16X200RE	2811450	TCS64X100BK	2811322
T10-L6	2380280	T50-M6	2380630	TBS48X10RE	2811041	TCS16X200TR	2811551	TCS64X100BR	2811610
T10-L8	2380285	T50-M8	2380640	TBS48X10WH	2811267	TCS16X200WH	2811480	TCS64X100BU	2811428
T10-M10	2380250	T6-L6	2380180	TBS48X10Y/G	2811166	TCS16X200YE	2811352	TCS64X100GN	2811398
T10-M5	2380220	T6-M4	2380110	TBS64X10BK	2811118	TCS190X100BK	2811330	TCS64X100GY	2811579
T10-M6	2380230	T6-M5	2380120	TBS64X10BR	2811243	TCS190X100BR	2811616	TCS64X100RE	2811458
T10-M8	2380240	T6-M6	2380130	TBS64X10BU	2811193	TCS190X100BU	2811434	TCS64X100TR	2811542
T120-L10	2381105	T6-M8	2380140	TBS64X10GY	2811218	TCS190X100GN	2811404	TCS64X100WH	2811488
T120-L12	2381110	T70-L10	2380790	TBS64X10RE	2811043	TCS190X100GY	2811585	TCS64X100Y/G	2811519
T120-M10	2381050	T70-L12	2380795	TBS64X10WH	2811269	TCS190X100RE	2811464	TCS64X100YE	2811360
T120-M12	2381060	T70-L8	2380785	TBS64X10Y/G	2811168	TCS190X100TR	2811548	TCS762X25BK	2811340
T120-M14	2381070	T70-M10	2380750	TBS95X10BK	2811120	TCS190X100WH	2811494	TCS762X25TR	2811557
T120-M16	2381080	T70-M12	2380760	TBS95X10BR	2811245	TCS190X100Y/G	2811525	TCS95X100BK	2811324
T120-M8	2381040	T70-M6	2380734	TBS95X10BU	2811195	TCS190X100YE	2811366	TCS95X100BR	2811612
T150-L10	2381305	T70-M8	2380740	TBS95X10GY	2811220	TCS20X200WH	2811481	TCS95X100BU	2811430
T150-L12	2381310	T95-L10	2380905	TBS95X10RE	2811045	TCS24X200BK	2811316	TCS95X100GN	2811400
T150-M10	2381250	T95-L12	2380910	TBS95X10WH	2811271	TCS24X200BR	2811604	TCS95X100GY	2811581
T150-M12	2381260	T95-M10	2380850	TBS95X10Y/G	2811170	TCS24X200BU	2811422	TCS95X100RE	2811460
T150-M14	2381270	T95-M12	2380860	TC025	2591895	TCS24X200GN	2811392	TCS95X100TR	2811544
T150-M16	2381280	T95-M14	2380870	TC04N	2591392	TCS24X200GY	2811573	TCS95X100WH	2811490
T150-M8	2381240	T95-M16	2380880	TC050	2597050	TCS24X200RE	2811452	TCS95X100Y/G	2811521
T16-L10	2380390	T95-M6	2380834	TC050Y	2597056	TCS24X200TR	2811552	TCS95X100YE	2811362
T16-L6	2380380	T95-M8	2380840	TC055	2591860	TCS24X200WH	2811482	TD-10X10-M10	2685011
T16-L8	2380385	TBS127X10BK	2811122	TC065-SC	2591870	TCS24X200YE	2811354	TD-11	2685005
T16-M10	2380350	TBS127X10BR	2811247	TC085	2597150	TCS254X50BK	2811332	TD-120X20-M20	2685013
T16-M5	2380320	TBS127X10BU	2811197	TC096	2597360	TCS254X50BR	2811618	TD-14X14-M14	2685012
T16-M6	2380330	TBS127X10GY	2811222	TC120	2597250	TCS254X50BU	2811436	TD-14X14-M14/1	2685004
T16-M8	2380340	TBS127X10RE	2811047	TCP10	3019220	TCS254X50GN	2811406	TD-16	2685002

Type/Code Cross-Reference chart

Type	Code	Type	Code	Type	Code	Type	Code	Type	Code
TD-19	2685008	TSS190TR	2811782	TSS64RE	2811686	VALSTAR-ND2/PKD	2590567	ZKE6-F	2590716
TD-20	2685001	TSS190WH	2811722	TSS64TR	2811776	VALSTAR-ND2/PKE	2590566	ZP2	2590760
TD-20X20-M20	2685014	TSS190Y/G	2811930	TSS64WH	2811716	VALSTAR-R3/IDT	2590593	ZS-B10	2842170
TD-20X20-M20-C	2685019	TSS190YE	2811812	TSS64Y/G	2811924	VALSTAR-V3-F	2590577	ZS-B16	2842185
TD-27	2685007	TSS24BK	2811650	TSS64YE	2811806	VALSTAR-ZETA	2844005	ZS-B6	2842156
TD-28.5	2685009	TSS24BR	2811890	TSS95BK	2811658	VAL-TC055	2593325	ZS-T10	2842175
TD-9	2685003	TSS24BU	2811740	TSS95BR	2811898	VAL-TC065-SC	2593324	ZS-T16	2842190
TD-M16C	2685010	TSS24GN	2811831	TSS95BU	2811748	VAL-TC085	2593323	ZS-T6	2842161
TF300-Q38F	2592862	TSS24GY	2811861	TSS95GN	2811839	VAL-TC120	2593322	ZS-U10	2842165
TF300-Q38FM	2592863	TSS24RE	2811680	TSS95GY	2811869	VP-M2	2048010	ZS-U16	2842180
TF600-Q38FM	2592981	TSS24TR	2811770	TSS95RE	2811688	VP-M3	2048030	ZS-U6	2842151
TGD-10X10-M9	2685018	TSS24WH	2811710	TSS95TR	2811778	VP-M3.5	2048070		
TGD-13.5X13.5M13	2685017	TSS24Y/G	2811918	TSS95WH	2811718	VP-M4	2048150		
TGM38	3016155	TSS24YE	2811800	TSS95Y/G	2811926	VP-M5	2048190		
TGM48	3016157	TSS254BK	2811664	TSS95YE	2811808	VP-M6	2048210		
TGM513	3016165	TSS254BR	2811904	UP130-120	2616520	VP-P10	2049210		
TGM58	3016159	TSS254BU	2811754	UP130-150	2616530	VP-PP12/19	2049370		
TGM613	3016167	TSS254GN	2811845	UP130-185	2616550	VP-U3	2048630		
TGM713	3016169	TSS254GY	2811875	UP130-240	2616560	VP-U3.5	2048670		
TGM817	3016171	TSS254RE	2811694	UP130-50	2616470	VP-U4	2048710		
TN120SE	2590280	TSS254TR	2811784	UP130-70	2616490	WF16	8420015		
TN70	2590230	TSS254WH	2811724	UP130-95	2616500	WF35	8420031		
TN70SE	2590260	TSS254Y/G	2811932	USB-CABLE	6006309	WF6	8420030		
TND10-120	2590145	TSS254YE	2811814	VAL-04	2593310	WL03-M	2469780		
TND6-70	2590120	TSS32BK	2811652	VAL-096	2593669	WL06-M	2469785		
TNF6-120	8160022	TSS32BR	2811892	VAL-1000	2593426	WL1-M	2469790		
TNF6-50	8160020	TSS32BU	2811742	VAL-130	2610450	WT2-3D	2636970		
TNN120	2590290	TSS32GN	2811833	VAL-130-U	2610451	Z10-1	2845030		
TNN70	2590240	TSS32GY	2811863	VAL-160	2593405	Z16-1	2845040		
TRD-9.4C	2685015	TSS32RE	2811682	VAL-22-TC120	2593391	Z16-12	2844156		
TRD-M11C	2685016	TSS32TR	2811772	VAL-230-630	2680085	Z16-12D	2844157		
TRS-B70	2593280	TSS32WH	2811712	VAL-231	2593384	Z16-3	2844115		
TSS127BK	2811660	TSS32Y/G	2811920	VAL-450	2593424	Z16-3D	2844116		
TSS127BR	2811900	TSS32YE	2811802	VAL-520	2593410	Z16-4	2844130		
TSS127BU	2811750	TSS380BK	2811666	VAL-600	2593425	Z16-4D	2844131		
TSS127GN	2811841	TSS380BR	2811906	VAL-75	2600110	Z16-5N	2844122		
TSS127GY	2811871	TSS380BU	2811756	VAL-B68RC3	2593412	Z16-5ND	2844123		
TSS127RE	2811690	TSS380GN	2811847	VAL-B-TC950	2593704	Z16-8	2844140		
TSS127TR	2811780	TSS380GY	2811877	VAL-CP096	2593671	Z16-8D	2844141		
TSS127WH	2811720	TSS380RE	2811696	VAL-CP096-W	2593674	Z2.5-1	2845010		
TSS127Y/G	2811928	TSS380TR	2811786	VAL-ECW-H3D	2593421	Z25-1	2845050		
TSS127YE	2811810	TSS380WH	2811726	VAL-FC470	2593710	Z25-DP7-100	2845180		
TSS12BK	2811646	TSS380Y/G	2811934	VALMAT-230-630	2680086	Z35-1	2845060		
TSS12BR	2811886	TSS380YE	2811816	VALMAT-520	2593411	Z35-26D	2844216		
TSS12BU	2811736	TSS48BK	2811654	VALMAT-W	2670076	Z35-3	2844205		
TSS12GN	2811827	TSS48BR	2811894	VAL-P1	2590595	Z35-3D	2844206		
TSS12GY	2811857	TSS48BU	2811744	VAL-P10	2590620	Z35-4	2844201		
TSS12RE	2811676	TSS48GN	2811835	VAL-P18	2590628	Z35-4D	2844202		
TSS12TR	2811766	TSS48GY	2811865	VAL-P21	2874156	Z35-6	2844210		
TSS12WH	2811706	TSS48RE	2811684	VAL-P22	2874157	Z35-6D	2844211		
TSS12Y/G	2811914	TSS48TR	2811774	VAL-P26	2590635	Z35-DP14-125	2845210		
TSS12YE	2811796	TSS48WH	2811714	VAL-P28	2590639	Z35-DP14B-125	2845212		
TSS16BK	2811648	TSS48Y/G	2811922	VAL-P29	2590641	Z35T-11	2844220		
TSS16BR	2811888	TSS48YE	2811804	VAL-P3	2590610	Z35T-11D	2844221		
TSS16BU	2811738	TSS510BK	2811668	VAL-P30	2590642	Z50-10D	2844230		
TSS16GN	2811829	TSS510BR	2811908	VAL-P38	2590650	Z50-DP12-160	2845220		
TSS16GY	2811859	TSS510BU	2811758	VAL-P39	2590651	Z6-1	2845020		
TSS16RE	2811678	TSS510GN	2811849	VAL-P4	2590612	Z6-10	2844106		
TSS16TR	2811768	TSS510GY	2811879	VAL-P40	2590652	Z6-10D	2844107		
TSS16WH	2811708	TSS510RE	2811698	VAL-P44	2590654	Z6-3	2844080		
TSS16Y/G	2811916	TSS510TR	2811788	VAL-P48	2590655	Z6-3D	2844081		
TSS16YE	2811798	TSS510WH	2811728	VAL-P51	2590658	Z6-5	2844100		
TSS190BK	2811662	TSS510YE	2811818	VAL-P54	2590661	Z6-5D	2844101		
TSS190BR	2811902	TSS64BK	2811656	VAL-P56	2590665	Z6-6	2844108		
TSS190BU	2811752	TSS64BR	2811896	VAL-P57	2590663	Z6-6D	2844109		
TSS190GN	2811843	TSS64BU	2811746	VAL-P59	2590667	ZKE2	2590710		
TSS190GY	2811873	TSS64GN	2811837	VAL-P7	2590616	ZKE610	2590718		
TSS190RE	2811692	TSS64GY	2811867	VALSTAR-ND2/PKC	2590565	ZKE616	2590725		

Comparison of AWG, MCM and Metric conductor cross sections

CONDUCTORS SECTIONS

Conversion Table AWG, MCM / mm²

[AWG]	Actual conductor csa mm ²	Comparable metric csa mm ²	[MCM]	Actual conductor csa mm ²	Comparable metric csa mm ²
27	0,10		250	127	120
26	0,13	0,14	300	152	150
25	0,16	-	350	177	185
24	0,21	0,2	400	203	-
23	0,26	0,25	500	253	240
22	0,33	0,34	600	304	300
21	0,41	-	700	355	-
20	0,52	0,5	800	405	400
19	0,65	-	900	456	-
18	0,82	0,75	1000	507	500
17	1,04	1	1250	633	625
16	1,31	-	1500	760	800
15	1,65	1,5	1750	887	-
14	2,08	-	2000	1010	1000
13	2,63	2,5			
12	3,31	-			
11	4,15	4			
10	5,27	6			
9	6,62	-			
8	8,35	-			
7	10,6	10			
6	13,3	-			
5	16,8	16			
4	21,2	-			
3	26,7	25			
2	33,6	35			
1	42,4	-			
1/0	53,4	50			
2/0	67,5	70			
3/0	85,0	95			
4/0	107,2	120			

MAXIMUM DIAMETERS OF CIRCULAR COPPER CONDUCTORS: SOLID, NON COMPACTED STRANDED AND FLEXIBLE

Cross sectional area [mm ²]	Conductors in cables for fixed installations		Flexible conductors (Classes 5 and 6) Maximum diameter [mm]
	Solid (Class 1) Maximum diameter [mm]	Stranded (Class 2) Maximum diameter [mm]	
0,5	0,9	1,1	1,1
0,75	1	1,2	1,3
1	1,2	1,4	1,5
1,5	1,5	1,7	1,8
2,5	1,9	2,2	2,4
4	2,4	2,7	3
6	2,9	3,3	3,9
10	3,7	4,2	5,1
16	4,6	5,3	6,3
25 ^a	5,7	6,6	7,8
35 ^a	6,7	7,9	9,2
50 ^a	7,8	9,1	11
70 ^a	9,4	11	13,1
95 ^a	11	12,9	15,1
120 ^a	12,4	14,5	17
150 ^a	13,8	16,2	19
185	15,4	18	21
240	17,6	20,6	24
300	19,8	23,1	27
400	22,2	26,1	31
500	-	29,2	35
630	-	33,2	39
800	-	37,6	-
1000	-	42,2	-

NOTE: The values given for flexible conductors represent both class 5 and class 6 conductors.

^a Solid copper conductor having cross-sectional areas of 25 mm² and above are for particular types of cable, e.g. mineral insulated, and not for general purposes.

MINIMUM AND MAXIMUM DIAMETERS OF STRANDED COMPACTED CIRCULAR COPPER, ALUMINIUM AND ALUMINIUM ALLOY CONDUCTORS

Cross-sectional area [mm ²]	Stranded compacted circular conductors (Class 2)	
	Minimum diameter [mm]	Maximum diameter [mm]
10	3,6	4,0
16	4,6	5,2
25	5,6	6,5
35	6,6	7,5
50	7,7	8,6
70	9,3	10,2
95	11,0	12,0
120	12,3	13,5
150	13,7	15,0
185	15,3	16,8
240	17,6	19,2
300	19,7	21,6
400	22,3	24,6
500	25,3	27,6
630	28,7	32,5

NOTES: - The dimensional limits of Aluminium conductors with cross-sectional areas above 630 mm² are not given as the compaction technology is not generally established.

- The values are given for compacted copper conductors in the size range 1,5 mm² to 6 mm².

MINIMUM AND MAXIMUM DIAMETERS OF CIRCULAR ALUMINIUM CONDUCTORS

Cross-sectional area [mm ²]	Solid conductors (Class 1)	
	Minimum diameter [mm]	Maximum diameter [mm]
10	3,4	3,7
16	4,1	4,6
25	5,2	5,7
35	6,1	6,7
50	7,2	7,8
70	8,7	9,4
95	10,3	11,0
120	11,6	12,4
150	12,9	13,8
185	14,5	15,4
240	16,7	17,6
300	18,8	19,8
400	21,2	22,2
500	24,0	25,1
630	27,3	28,4
800	30,9	32,1
1000	34,8	36,0
1200	37,8	39,0

IEC 60228 : 2004 - 11 conductor tables

CLASS 1:

SOLID CONDUCTORS FOR SINGLE-CORE AND MULTI-CORE CABLES

Nominal cross-sectional area [mm ²]	Maximum resistance of conductor at 20 °C		
	Circular, annealed Copper conductors		Aluminium and Aluminium alloy conductors, circular or shaped c [ohm/km]
	Plain [ohm/km]	Metal [ohm/km]	
0,5	36	36,7	-
0,75	24,5	24,8	-
1	18,1	18,2	-
1,5	12,1	12,2	-
2,5	7,41	7,56	-
4	4,61	4,70	-
6	3,08	3,11	-
10	1,83	1,84	3,08 a
16	1,15	1,16	1,91 a
25	0,727 ^b	-	1,20 ^a
35	0,524 ^b	-	0,868 ^a
50	0,387 ^b	-	0,641
70	0,268 ^b	-	0,443
95	0,193 ^b	-	0,320 d
120	0,153 ^b	-	0,253 d
150	0,124 ^b	-	0,206 d
185	0,101 ^b	-	0,164 d
240	0,0775 ^b	-	0,125 d
300	0,0620 b	-	0,100 d
400	0,0465 b	-	0,0778
500	-	-	0,0605
630	-	-	0,0469
800	-	-	0,0367
1000	-	-	0,0291
1200	-	-	0,0247

^a Aluminium conductors 10 mm² to 35 mm² circular only

^b Solid Copper conductors having nominal cross-sectional area of 25 mm² and above are for particular types of cable, e.g. mineral insulated, and not for general purposes.

^c For solid Aluminium alloy conductors, having the same nominal cross-sectional area as an Aluminium conductor, the resistance value given in the table should be multiplied by a factor of 1,162 unless otherwise agreed between the manufacturer and the purchaser.

^d For single core cables, four sectoral shaped conductors may be assembled into a single circular conductor. The maximum resistance of the assembled conductor shall be 25% of that of the individual component conductors.

CLASS 2:

STRANDED CONDUCTORS FOR SINGLE-CORE AND MULTI-CORE CABLES

Nominal cross-sectional area [mm ²]	Minimum number of wires in the conductor						Maximum resistance of conductor at 20 °C		
	Circular		Circular compacted		Shaped		Annealed copper conductor		Aluminium or aluminium alloy conductor ^c [ohm/km]
	Cu	Al	Cu	Al	Cu	Al	Plain wires [ohm/km]	Metal-coated wires [ohm/km]	
0,5	7	-	-	-	-	-	36,0	36,7	-
0,75	7	-	-	-	-	-	24,5	24,8	-
1,0	7	-	-	-	-	-	18,1	18,2	-
1,5	7	-	6	-	-	-	12,1	12,2	-
2,5	7	-	6	-	-	-	7,41	7,56	-
4	7	-	6	-	-	-	4,61	4,70	-
6	7	-	6	-	-	-	3,08	3,11	-
10	7	7	6	6	-	-	1,83	1,84	3,08
16	7	7	6	6	-	-	1,15	1,16	1,91
25	7	7	6	6	6	6	0,727	0,734	1,20
35	7	7	6	6	6	6	0,524	0,529	0,868
50	19	19	6	6	6	6	0,387	0,391	0,641
70	19	19	12	12	12	12	0,268	0,270	0,443
95	19	19	15	15	15	15	0,193	0,195	0,320
120	37	37	18	15	18	15	0,153	0,154	0,253
150	37	37	18	15	18	15	0,124	0,126	0,206
185	37	37	30	30	30	30	0,0991	0,100	0,164
240	61	61	34	30	34	30	0,0754	0,0762	0,125
300	61	61	34	30	34	30	0,0601	0,0607	0,100
400	61	61	53	53	53	53	0,0470	0,0475	0,0778
500	61	61	53	53	53	53	0,0366	0,0369	0,0605
630	91	91	53	53	53	53	0,0283	0,0286	0,0469
800	91	91	53	53	-	-	0,0221	0,0224	0,0367
1000	91	91	53	53	-	-	0,0176	0,0177	0,0291
1200			b				0,0151	0,0151	0,0247
1400 a			b				0,0129	0,0129	0,0212
1600			b				0,0113	0,0113	0,0186
1800 a			b				0,0101	0,0101	0,0165
2000			b				0,0090	0,0090	0,0149
2500			b				0,0072	0,0072	0,0127

^a Non-preferred sizes. Other non-preferred sizes are recognized for some specialized applications but are not within the scope of this standard.

^b The minimum number of wires for these sizes is not specified. These sizes may be constructed from 4, 5 or 6 equal segments (Milliken).

^c For stranded Aluminium alloy conductors having the same nominal cross-sectional area as an Aluminium conductor the resistance value should be agreed between the manufacturer and the purchaser.

IEC 60228 : 2004 - 11 conductor tables

CLASS 5:

FLEXIBLE COPPER CONDUCTORS FOR SINGLE-CORE AND MULTI-CORE CABLES

Nominal cross-sectional [mm ²]	Maximum diameter of wires in conductor [mm]	Maximum resistance of conductor at 20 °C	
		Plain wires [ohm/km]	Metal-coated wires [ohm/km]
0,5	0,21	39	40,1
0,75	0,21	26	26,7
1	0,21	19,5	20
1,5	0,26	13,3	13,7
2,5	0,26	7,98	8,21
4	0,31	4,95	5,09
6	0,31	3,3	3,39
10	0,41	1,91	1,95
16	0,41	1,21	1,24
25	0,41	0,78	0,795
35	0,41	0,554	0,565
50	0,41	0,386	0,393
70	0,51	0,272	0,277
95	0,51	0,206	0,21
120	0,51	0,161	0,164
150	0,51	0,129	0,132
185	0,51	0,106	0,108
240	0,51	0,080	0,081
300	0,51	0,064	0,065
400	0,51	0,048	0,049
500	0,61	0,038	0,039
630	0,61	0,028	0,029

CLASS 6:

FLEXIBLE COPPER CONDUCTORS FOR SINGLE-CORE AND MULTI-CORE CABLES

Nominal cross-sectional [mm ²]	Maximum diameter of wires in conductor [mm]	Maximum resistance of conductor at 20 °C	
		Plain wires [ohm/km]	Metal-coated wires [ohm/km]
0,5	0,16	39	40,1
0,75	0,16	26	26,7
1	0,16	19,5	20
1,5	0,16	13,3	13,7
2,5	0,16	7,98	8,21
4	0,16	4,95	5,09
6	0,21	3,3	3,39
10	0,21	1,91	1,95
16	0,21	1,21	1,24
25	0,21	0,78	0,795
35	0,21	0,554	0,565
50	0,31	0,386	0,393
70	0,31	0,272	0,277
95	0,31	0,206	0,21
120	0,31	0,161	0,164
150	0,31	0,129	0,132
185	0,41	0,106	0,108
240	0,41	0,080	0,081
300	0,41	0,064	0,065

- H Cable conforming to harmonised standards
- A Recognised national type of cable
- N Other type of national cable

- 00 Less than 100 / 100 V
- 01 Above 100 / 100 V and less than 300 / 300 V
- 03 300 / 300 V
- 05 300 / 500 V
- 07 450 / 750 V
- 1 0,6 / 1 kV

- B Ethylenpropylene rubber for working temperature of 60° C
- N Polychloroprene
- N2 Polychloroprene for welding cables
- Q Polyurethane
- R Rubber
- V Common-quality PVC
- V2 PVC for working temperatures of 90° C
- V3 PVC for low temperature cables
- V4 Reticulate PVC
- V5 Oil-resistant PVC
- Z Polyolefin mixture

- C Concentric Copper core
- C4 Copper braid screen on multiple cores
- C5 Copper braid screen on single cores
- C7 Screen made of Copper straps or ribbons

- Z2 Round Steel strand armour
- Z3 Steel strap armour
- Z4 Steel ribbon armour
- Z5 Steel strand braid

- H Flat divisible cable with or without sheath
- H2 Flat indivisible cable
- H3 Flat cable with cores separated by a slat
- H6 Flat cable with three or more cores
- H7 Cable with double-layered insulation
- H8 Extendable cord

- D Flexible core for weldings cables
- E Very flexible core for welding cables
- F Flexible core for moving connections
- H Very flexible core for moving connections
- K Flexible core for fixed laying
- R Rigid round cord
- U Round rigid single strand

REFERENCE TO THE STANDARDS

RATED VOLTAGE

INSULATION AND SHEATH MATERIAL

SCREENS

ARMOURS

CONSTRUCTIVE FORM OF THE CABLE

CONDUCTOR FLEXIBILITY DEGREE

UL and VDE marking of cable glands

MAXIblock® *spiralblock*®

Type (*)	Thread	COMPRESSION RANGE Ø (min-max)			IMPACT CATEGORY (*)	MARKING	
		Nominal [mm]	UL 514B				
			[mm]	[inches]			
1900.M12	M12x1,5	3,5-7	4,5	0.18	3,5-7	1	USR-CNR / VDE
1900.M16	M16x1,5	5-10	7	0.28	7-10	1	USR-CNR / VDE
1900.M20	M20x1,5	7-13	13	0.51	8-13	3	USL-CNL / VDE
1900.M25	M25x1,5	10-17	17	0.67	10-17	3	USL-CNL / VDE
1900.M32	M32x1,5	13-21	15-21	0.60-0.83	15-21	3	USL-CNL / VDE
1900.M40	M40x1,5	19-28	21-28	0.83-1.10	19-28	3	USL-CNL / VDE
1900.M50	M50x1,5	27-35	27-34	1.06-1.34	27-35	3	USL-CNL / VDE
1900.M63	M63x1,5	34-45	35-45	1.38-1.77	34-45	3	USL-CNL / VDE
1910.M12	M12x1,5	2-5	3-5	0.12-0.20	2-5	1	USR-CNR / VDE
1910.M16	M16x1,5	3-7	5-7	0.20-0.28	5-7	1	USR-CNR / VDE
1910.M20	M20x1,5	5-10	5-10	0.20-0.40	6-10	3	USR-CNR / VDE
1910.M25	M25x1,5	7-13	7-13	0.28-0.51	7-13	3	USR-CNR / VDE
1910.M32	M32x1,5	8-14	8-14	0.31-0.55	8-14	3	USR-CNR / VDE
1910.M40	M40x1,5	15-23	17-23	0.67-0.91	15-23	3	USL-CNL / VDE
1910.M50	M50x1,5	20-29	21-29	0.83-1.14	21-29	3	USL-CNL / VDE
1910.M63	M63x1,5	27-39	28-39	1.1-1.54	28-39	3	USL-CNL / VDE
1901.M12	M12x1,5	3,5-7	4,5	0.18	3,5-7	1	USR-CNR / VDE
1901.M16	M16x1,5	5-10	7	0.28	5-10	1	USR-CNR / VDE
1901.M20	M20x1,5	7-13	13	0.51	8-13	3	USL-CNL / VDE
1901.M25	M25x1,5	10-17	17	0.67	10-17	3	USL-CNL / VDE
1901.M32	M32x1,5	13-21	15-21	0.60-0.83	15-21	3	USL-CNL / VDE
1901.M40	M40x1,5	19-28	21-28	0.83-1.10	19-28	3	USL-CNL / VDE
1901.M50	M50x1,5	27-35	27-34	1.06-1.34	27-35	3	USL-CNL / VDE
1901.M63	M63x1,5	34-45	35-45	1.38-1.77	34-45	3	USL-CNL / VDE
1500.M12	M12x1,5	3,5-7	4,5	0.18	3,5-7	1	USR-CNR / VDE
1500.M16	M16x1,5	5-10	7	0.28	7-10	1	USR-CNR / VDE
1500.M20	M20x1,5	7-13	13	0.51	8-13	3	USL-CNL / VDE
1500.M25	M25x1,5	10-17	17	0.67	10-17	3	USL-CNL / VDE
1500.M32	M32x1,5	13-21	15-21	0.60-0.83	15-21	3	USL-CNL / VDE

MAXIbrass®

Type	Thread	COMPRESSION RANGE Ø (min-max)			MARKING
		Nominal [mm]	UL 514B		
			[mm]	[inches]	
2900.07N	Pg 7	3-7	3-7	0.12-0.28	USR-CNR
2900.09N	Pg 9	4-8	4-8	0.16-0.31	USR-CNR
2900.11N	Pg 11	4,5-10	6-10	0.24-0.39	USR-CNR
2900.13N	Pg 13,5	5-12	10-12	0.39-0.47	USL-CNL
2900.16N	Pg 16	7-13	10-13	0.39-0.51	USL-CNL
2900.21N	Pg 21	10-17	12-17	0.47-0.67	USL-CNL
2900.29N	Pg 29	17-25	18-25	0.71-0.98	USL-CNL
2900.36N	Pg 36	20-32	23-32	0.91-1.26	USL-CNL
2900.42N	Pg 42	28-38	28-35	1.10-1.38	USL-CNL
2900.48N	Pg 48	34-45	34-45	1.33-1.77	USL-CNL
2910.07N	Pg 7	1-5	2-5	0.08-0.20	USR-CNR
2910.09N	Pg 9	2-6	3-6	0.12-0.24	USR-CNR
2910.11N	Pg 11	2,5-7	3,5-7	0.14-0.28	USR-CNR
2910.13N	Pg 13,5	4-10	5,5-10	0.22-0.39	USR-CNR
2910.16N	Pg 16	5-10	6-10	0.24-0.39	USR-CNR
2910.21N	Pg 21	6-13	7-13	0.28-0.51	USR-CNR
2910.29N	Pg 29	11-20	12-20	0.47-0.79	USR-CNR
2910.36N	Pg 36	18-26	19-26	0.75-1.02	USL-CNL
2910.42N	Pg 42	24-31	24-31	0.94-1.22	USL-CNL
2910.48N	Pg 48	27-39	31-39	1.22-1.54	USL-CNL
2901.07N	Pg 7	3-7	3-7	0.12-0.28	USR-CNR
2901.09N	Pg 9	4-8	4-8	0.16-0.31	USR-CNR
2901.11N	Pg 11	4,5-10	6-10	0.24-0.39	USR-CNR
2901.13N	Pg 13,5	5-12	10-12	0.39-0.47	USL-CNL
2901.16N	Pg 16	7-13	10-13	0.39-0.51	USL-CNL
2901.21N	Pg 21	10-17	12-17	0.47-0.67	USL-CNL
2901.29N	Pg 29	17-25	18-25	0.71-0.98	USL-CNL
2901.36N	Pg 36	20-32	23-32	0.91-1.26	USL-CNL
2901.42N	Pg 42	28-38	28-35	1.10-1.38	USL-CNL
2911.07N	Pg 7	1-5	2-5	0.08-0.20	USR-CNR
2911.09N	Pg 9	2-6	3-8	0.12-0.31	USR-CNR
2911.11N	Pg 11	2,5-7	3,5-7	0.14-0.28	USR-CNR
2911.13N	Pg 13,5	4-10	5,5-10	0.22-0.39	USR-CNR
2911.16N	Pg 16	5-10	6-10	0.24-0.39	USR-CNR
2911.21N	Pg 21	6-13	7-13	0.28-0.51	USR-CNR
2911.29N	Pg 29	11-20	12-20	0.47-0.79	USR-CNR
2911.36N	Pg 36	18-26	19-26	0.75-1.02	USL-CNL
2911.42N	Pg 42	24-31	24-31	0.94-1.22	USL-CNL

VDE: Licence nos 40008472, 40008474, 40008475 and 40008476

USL-CNL: UL LISTING file no E220310; control no 485B valid in USA & Canada

USR-CNR: UL RECOGNITION file no E220310 valid in USA & Canada (with reduced tightening force)

MAXIblock® *spiralblock*®

Type (*)	Thread	COMPRESSION RANGE Ø (min-max)			MARKING
		Nominal [mm]	UL 514B		
			[mm]	[inches]	
1900.07	Pg 7	3,5-7	4,5-6,5	0.18-0.25	USR-CNR
1900.09	Pg 9	5-8	6-8	0.24-0.31	USR-CNR
1900.11	Pg 11	5-10	6,5-9,5	0.26-0.37	USR-CNR
1900.13	Pg 13,5	7-12	8-11,5	0.31-0.45	USL-CNL
1900.16	Pg 16	10-14	10,5-14	0.41-0.55	USL-CNL
1900.21	Pg 21	13-18	13-18	0.51-0.71	USL-CNL
1900.29	Pg 29	18-25	22-25	0.67-0.98	USL-CNL
1900.36	Pg 36	20-32	21,5-32	0.85-1.26	USR-CNR
1900.42	Pg 42	28-38	32-38	1.26-1.49	USL-CNL
1900.48	Pg 48	34-45	40-44	1.57-1.73	USL-CNL
1910.07	Pg 7	2-5	3-5	0.12-0.20	USR-CNR
1910.11	Pg 11	4-7	4-7	0.16-0.28	USR-CNR
1910.13	Pg 13	5-10	10	0.39	USR-CNR
1910.21	Pg 21	9-15	10-14	0.39-0.55	USR-CNR
1910.36	Pg 36	18-26	18-26	0.71-1.02	USR-CNR
1910.42	Pg 42	25-31	25-31	0.98-1.22	USL-CNL
1910.07	Pg 7	3,5-7	6,5	0.26	USR-CNR
1910.09	Pg 9	5-8	6-8	0.24-0.31	USR-CNR
1910.11	Pg 11	5-10	6,5-9,5	0.26-0.37	USR-CNR
1910.13	Pg 13,5	7-12	8-11,5	0.31-0.45	USL-CNL
1910.16	Pg 16	10-14	10,5-14	0.41-0.55	USL-CNL
1910.21	Pg 21	13-18	13-18	0.51-0.71	USL-CNL
1910.29	Pg 29	18-25	22-25	0.67-0.98	USL-CNL
1910.36	Pg 36	20-32	21,5-32	0.85-1.26	USR-CNR
1910.42	Pg 42	28-38	32-38	1.26-1.48	USL-CNL
1910.48	Pg 48	34-45	40-44	1.57-1.73	USL-CNL
1500.07	Pg 7	3,5-7	4,5-6,5	0.18-0.25	USR-CNR
1500.09	Pg 9	5-8	6-8	0.24-0.31	USR-CNR
1500.11	Pg 11	5-10	6,5-9,5	0.26-0.37	USR-CNR
1500.13	Pg 13,5	7-12	8-11,5	0.31-0.45	USL-CNL
1500.16	Pg 16	10-14	10,5-14	0.41-0.55	USL-CNL
1500.21	Pg 21	13-18	13-18	0.51-0.71	USL-CNL
1900.14	G1/4"	3-6,5	4,5-6,5	0.18-0.25	USR-CNR
1900.38	G3/8"	4-8	6-8	0.24-0.31	USR-CNR
1900.12	G1/2"	7-12	8-11,5	0.31-0.45	USL-CNL
1900.34	G3/4"	13-18	13-18	0.51-0.71	USL-CNL
1901.12	G1/2"	7-12	8-11,5	0.31-0.45	USL-CNL
1500.14	G1/4"	3-6,5	4,5-6,5	0.18-0.25	USR-CNR
1500.38	G3/8"	4-8	6-8	0.24-0.31	USR-CNR
1500.12	G1/2"	7-12	8-11,5	0.31-0.45	USL-CNL
1500.34	G3/4"	13-18	13-18	0.51-0.71	USL-CNL

MAXIbrass®

Type	Thread	COMPRESSION RANGE Ø (min-max)			IMPACT CATEGORY (*)	MARKING	
		Nominal [mm]	UL 514B				
			[mm]	[inches]			
2900.M12N	M12x1,5	3-7	3-7	0.12-0.28	3-7	5	USR-CNR / VDE
2900.M16N	M16x1,5	4,5-10	6-10	0.24-0.39	4,5-10	6	USR-CNR / VDE
2900.M20N	M20x1,5	7-13	8-13	0.31-0.51	7-13	6	USL-CNL / VDE
2900.M25N	M25x1,5	10-17	13-17	0.51-0.67	11-17	6	USL-CNL / VDE
2900.M32N	M32x1,5	11-21	13-21	0.51-0.83	13-21	6	USL-CNL / VDE
2900.M40N	M40x1,5	19-28	21-28	0.83-1.10	19-28	6	USL-CNL / VDE
2900.M50N	M50x1,5	26-35	27-35	1.06-1.38	26-35	6	USL-CNL / VDE
2900.M63N	M63x1,5	34-45	34-45	1.33-1.77	34-45	6	USL-CNL / VDE
2910.M12N	M12x1,5	1-5	2-5	0.08-0.20	2-5	5	USR-CNR / VDE
2910.M16N	M16x1,5	2,5-7	3,5-7	0.14-0.28	4-7	6	USR-CNR / VDE
2910.M20N	M20x1,5	5-10	5-10	0.20-0.39	5,5-10	6	USR-CNR / VDE
2910.M25N	M25x1,5	6-13	8-13	0.31-0.51	6-13	6	USR-CNR / VDE
2910.M32N	M32x1,5	7-14	7-14	0.28-0.55	9-14	6	USR-CNR / VDE
2910.M40N	M40x1,5	13-23	15-23	0.59-0.90	17-23	6	USL-CNL / VDE
2910.M50N	M50x1,5	20-29	20-29	0.79-1.14	25-29	6	USL-CNL / VDE
2910.M63N	M63x1,5	27-39	28-39	1.10-1.54	31-39	6	USL-CNL / VDE
2901.M12N	M12x1,5	3-7	3-7	0.12-0.28	3-7	5	USR-CNR / VDE
2901.M16N	M16x1,5	4,5-10	6-10	0.24-0.39	4,5-10	6	USR-CNR / VDE
2901.M20N	M20x1,5	7-13	8-13	0.31-0.51	7-13	6	USL-CNL / VDE
2901.M25N	M25x1,5	10-17	13-17	0.51-0.67	11-17	6	USL-CNL / VDE
2901.M32N	M32x1,5	11-21	13-21	0.51-0.83	13-21	6	USL-CNL / VDE
2901.M40N	M40x1,5	19-28	21-28	0.83-1.10	19-28	6	USL-CNL / VDE
2901.M50N	M50x1,5	26-35	27-35	1.06-1.38	26-35	6	USL-CNL / VDE
2911.M12N	M12x1,5	1-5	2-5	0.08-0.20	2-5	5	USR-CNR / VDE
2911.M16N	M16x1,5	2,5-7	3,5-7	0.14-0.28	4-7	6	USR-CNR / VDE
2911.M20N	M20x1,5	5-10	5-10	0.20-0.39	5,5-10	6	USR-CNR / VDE
2911.M25N	M25x1,5	6-13	8-13	0.31-0.51	6-13	6	USR-CNR / VDE
2911.M32N	M32x1,5	7-14	7-14	0.28-0.55	9-14	6	USR-CNR / VDE
2911.M40N	M40x1,5	13-23	15-23	0.59-0.90	17-23	6	USL-CNL / VDE
2911.M50N	M50x1,5	20-29	20-29	0.79-1.14	25-29	6	USL-CNL / VDE

(*) Add to Ref: N for Black, G for Dark Grey

(*) EN 62444 § 9.5

Ingress protection (IP) rating according to EN 60529 - CEI 70-1

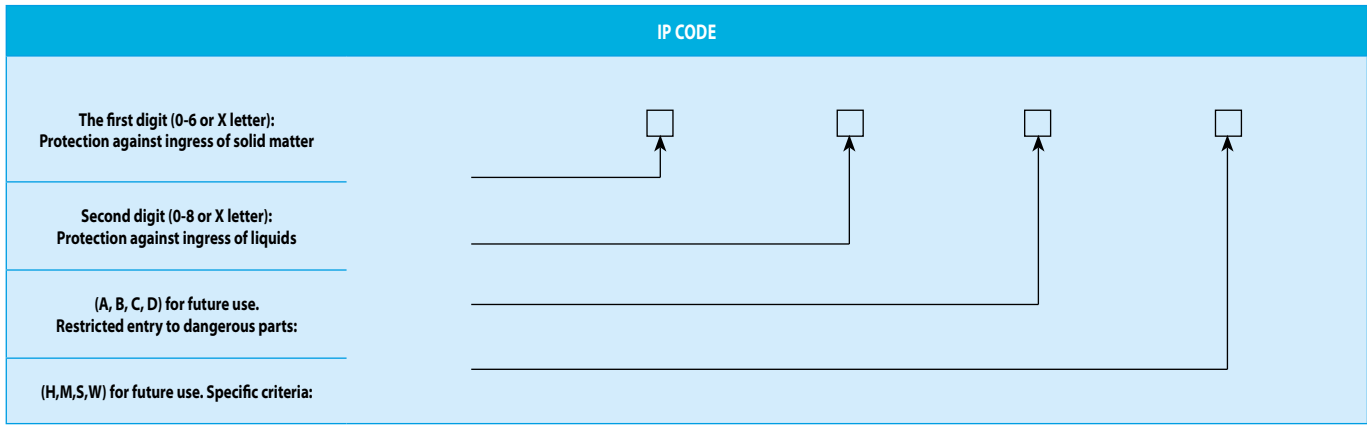

1st CHARACTERISTIC NUMBER:



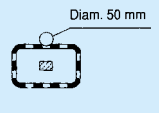
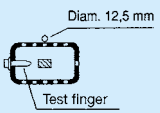
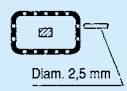
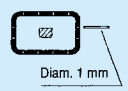
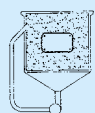
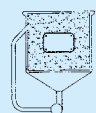

PROTECTION AGAINST INGRESS OF SOLID MATTER

PROTECTION	0	1	2	3	4	5	6
Protection against ingress of solid matter caused by		solid bodies measuring over 50 mm	solid bodies measuring over 12,5 mm	solid bodies measuring over 2,5 mm	solid bodies measuring over 1 mm	powder in harmful quantities	Powder (completely protected)
Test method		 <p>Diam. 50 mm</p> <p>Accessibility gauge ø 50 mm</p>	 <p>Diam. 12,5 mm</p> <p>Test finger</p> <p>Accessibility gauge ø 12,5 mm</p>	 <p>Diam. 2,5 mm</p> <p>Accessibility gauge ø 2,5 mm</p>	 <p>Diam. 1 mm</p> <p>Accessibility gauge ø 1 mm</p>	 <p>talcum powder</p>	 <p>talcum powder</p>

Ingress protection (IP) rating according to EN 60529 - CEI 70-1

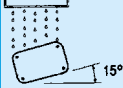
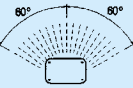
2nd CHARACTERISTIC NUMBER:

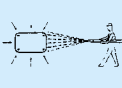
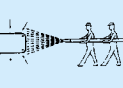
PROTECTION AGAINST INGRESS OF LIQUIDS

PROTECTION	0	1	2	3	4	5	6	7	8
Protection against ingress of liquids caused by		Drops of water falling vertically	Vertical drops of water with inclination of casing up to 15°	Rain	Sprays of water	Jets of water	Powerful jets of water	Temporary Immersion	Permanent Immersion
Test method									Agreement between manufacturer and user but more severe than 7

1st ADDITIONAL LETTER:

RESTRICTED ENTRY TO DANGEROUS PARTS

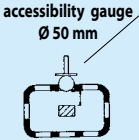
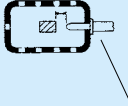
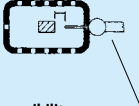
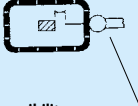
RESTRICTED ENTRY	A	B	C	D
Restricted entry to dangerous parts caused by	back of hand	finger	tool	wire
Test method				

2nd ADDITIONAL LETTER :

MEANING OF THE SECOND ADDITIONAL LETTER

SPECIFIC CRITERIA	H	M	S	W
Specific criteria	High voltage equipment	Tested against negative effects of water penetration, when the moveable parts of the equipment (e.g. wheels of a revolving machine) are moving	Tested against the negative effects of water penetration, when the moveable parts of the equipment (e.g. wheels of a revolving machine) are stationary	Suitable for use in environmental conditions as specified and equipped with additional measures of protection

Flammability test for products and materials

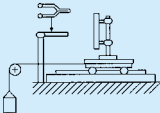
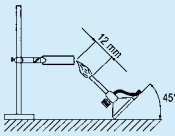
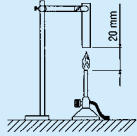
TYPE OF TEST	TEST EQUIPMENT	COMPLIANCE WITH STANDARDS	OBJECTIVE OF TEST	TEST RESULTS	TEST CONDITIONS		
					heat source	length of test	characteristic features
CHARACTERISTIC FEATURES		IEC 695-2-1 CEI 50-11 DIN VDE 0471-2-1	Check that abnormal heating produced by overcurrent and bad contacts does not compromise the safety of the insulating material. Lighting test. The wire is pressed against the sample using force and penetrates up to 7 mm.	Any sign of flame starting must stop within 30 sec. of removing the glowing wire. TEST TEMPERATURE • 650° for materials which do not support parts under tension • 750° for materials which support parts under tension of moving sockets and plugs • 850° for materials which support parts under tension of fixed sockets and switches	Glow-wire 4 mm in diameter	Wire applied for 30 seconds	Flame extinction time
NEEDLE FLAME		IEC 695-2-1 CEI 50-11	Simulates the effect small flames have which may occur due to internal faults of products in order to judge the fire risk.	<ul style="list-style-type: none"> the sample does not catch fire the flame and incandescent particles do not spread the fire combustion lasts less than 30 seconds 	Bunsen burner flame	Flame applied for (Ta) 5, 10, 20, 30, 60, 120 sec. According to particular standards	The degree of severity: flame application time (Ta)
UL (UNDERWRITER LABORATORIES)		UL 94	Measuring of time the sample continues to burn after the direct flame has been removed.	<ul style="list-style-type: none"> V0 if the sample burns for less than 5 sec. before going out. V1 if it burns for less than 25 sec. V2 if it burns for less than 25 sec. With incandescent drops HB if it burns for more than 25 sec. (horizontal sample and burning speed less than 38 mm per minute) Comparable to ASTM D-635	Bunsen burner flame	Flame applied for 10 seconds twice following	Length of combustion

Recommended torque settings for cable glands

MAXIblock[®], spiralblock[®], MAXIbrass[®], MAXIinox[®] METRIC THREADS, TO OBTAIN IP68 INGRESS PROTECTION IN ACCORDANCE WITH EN 60529/A2

Torque values apply to mounting in a threaded entry and to use with a locknut	THREAD CABLE GLAND	CABLE GLAND	
		metallic	non-metallic
		torque (Nm)	
	M12 x 1,5	6.0	2.7
	M16 x 1,5	6.0	5.0
	M20 x 1,5	8.0	7.0
	M25 x 1,5	8.0	7.5
	M32 x 1,5	18.0	8.0
	M40 x 1,5	18.0	8.0
	M50 x 1,5	18.0	15.0
	M63 x 1,5	25.0	15.0

MAXIblock[®], spiralblock[®], MAXIbrass[®], MAXIinox[®] PG THREADS, TO OBTAIN IP68 INGRESS PROTECTION IN ACCORDANCE WITH EN 60529/A2

Torque values apply to mounting in a threaded entry and to use with a locknut	THREAD CABLE GLAND	CABLE GLAND	
		metallic	non-metallic
		torque (Nm)	
	Pg7	6.25	2.5
	Pg9	6.25	3.75
	Pg11	6.25	3.75
	Pg13,5	7.5	5.0
	Pg16	7.5	5.0
	Pg21	10.0	7.5
	Pg29	15.0	8.0
	Pg36	25.0	10.0
	Pg42	25.0	10.0
	Pg48	25.0	15.0

MAXIblock[®], spiralblock[®] GAS THREADS, TO OBTAIN IP68 INGRESS PROTECTION IN ACCORDANCE WITH EN 60529/A2

Torque values apply to mounting in a threaded entry and to use with a locknut	THREAD CABLE GLAND	NON-METALLIC CABLE GLAND
		torque (Nm)
		G1/4"
G3/8"	5	
G1/2"	6	
G3/4"	10	

Cable glands installation:

- 1) Before proceeding with the installation, inspect the cable gland; installation must be performed by qualified personnel and with suitable tools.
- 2) Cable glands must be used in their original supplied condition with no modifications.
- 3) Torque values listed in the catalogue are intended as the recommended level for reaching the correct IP protection level and achieving the required cable retention properties. As the torque depends on the type of insulation of the conductor used, it is responsibility of the user to define the ideal torque for their specific application.
- 4) Both the body and head of the cable gland must be correctly tightened; excessive or reduced tightening may compromise the protection level and the cable retention performance.
- 5) Loosening a cable gland already installed and then tightening again may result in a reduction of the IP protection level achieved and compromise the cable retention properties. In these instances, we recommend replacement of the cable gland.



New Hand Tool Range

professional

the new range of hand tools includes:

- Scissors
- Screwdrivers
- Socket & torque wrenches
- Pliers, nippers & grips
- Tool holders & kits
- Spanners & hammers
- Cutters, saws & files
- Digital instruments
- Measuring tapes, spirit levels & chalk lines
- Hole making accessories
- Portable LED lights





Identification & Labelling

systems

the system includes:

- Thermal transfer printer for sheet media
- Thermal transfer printer for roll media
- Embosser
- Manual system
- Accessories
- Labels



ROLY

GENERAL TERMS AND CONDITIONS OF SALE

1. GENERAL TERMS

- For the purpose of these GENERAL TERMS AND CONDITIONS OF SALE (the "Terms and Conditions"), the following definitions shall apply:
 - «Sellen»: CEMBRE S.p.A. and its affiliates;
 - «Affiliate»: any entity directly or indirectly, through one or more intermediaries, controlling, controlled by, or under common control with CEMBRE S.p.A.;
 - «Buyer»: any professional or entrepreneur purchasing the Products from the Seller;
 - «Products»: the goods manufactured and/or sold by the Seller;
 - «Order(s)»: each proposal for the purchase of the Products submitted by the Buyer to the Seller in writing;
 - «Sale(s)»: each single sale agreement entered into further to the receipt by the Buyer of the written order confirmation of the Seller.
- These Terms and Conditions govern the sale of equipment, components, parts, and materials (the "Products") supplied by the Seller to the Buyer. Any specific supply agreement, order confirmation, quotation, these Terms and Conditions and the purchase order form the Sales Agreement ("Agreement") between the parties. In the event of a conflict between these documents, precedence shall apply in accordance with the order listed in the previous sentence.
- CEMBRE's quotation, proposal or order confirmation is conditional on the Buyer's acceptance of these Terms and Conditions. Buyer's silence or acceptance/use of the Products or services related to any purchase order shall constitute tacit approval of these Terms and Conditions.
- Any additional or conflicting terms included in the Buyer's request for quotation/proposal, specifications, purchase order or any other written or oral communication are not binding on CEMBRE unless separately signed by CEMBRE. CEMBRE's failure to object to Buyer's additional or conflicting terms (including the Buyer's Terms and Conditions of Purchase) does not operate as a waiver of any terms contained herein.

2. ORDERING PROCEDURES

- Offers of the Seller are not binding. This shall also apply if the Seller has provided the Buyer with catalogs, technical documentation (e.g. drawings, plans, calculations, calculations, references to DIN standards), other product descriptions or documents - also in electronic form - to which the Seller reserves property rights and copyrights pursuant to Clause 8.
- Unless otherwise agreed, the information in offers and order confirmations shall refer to the contents of the respectively valid price lists, catalogs or other documents - also in electronic form, including technical data sheets, of the Seller.
- All orders must be sent in writing and include all the details for a correct identification of the Products and Services requested. The minimum order amount is € 250.
- The order is an irrevocable proposal to buy, but it is accepted by the Seller only following order acknowledgement / confirmation or execution.
- The Buyer may request in writing to cancel or modify the order only prior to its execution and the Seller may at its own discretion accept or reject such request. Only cancellations and modifications expressly accepted by the Seller in writing shall be valid and effective.

3. PRICING AND PAYMENT TERMS

- Unless otherwise specified in writing, Seller's quotations have a 30-day validity, after which they will automatically expire.
- Prices quoted in price-lists and marketing materials are not binding and cannot be considered a "public offer". Unless otherwise agreed in writing, prices are always quoted based on delivery term FCA (Incoterms latest version) net of any applicable statutory value added /goods and services tax and of any applicable taxes and duties.
- The Seller reserves the right to update the price-list without prior notice; the new release of the price-list will apply to all the Orders placed after the date such new release is issued and sent to the Buyer. Invoices will be issued in accordance with the prices in force on the date of the order confirmation or as otherwise agreed in specific supply agreements.
- In the event of late payment, the Seller will have the right to charge overdue interest in accordance with the provisions of law no. 231/2002. Any further claim for damages caused by delay shall remain unaffected.
- In the event of payment arrears, suspension of payments and if circumstances become known which are likely to reduce the creditworthiness of the customer, the Seller shall be entitled, after having granted a period of grace, to declare all claims arising from the entire business relationship with the customer immediately due for payment. Discount agreements, rebates and the like shall be deemed forfeited in this case.
- Failure to pay or delayed payments above 30 days also entitle the Seller to suspend the delivery of the Products and terminate every single Sale entered into. The suspension of the delivery of the Products or the termination of any Sale shall not entitle the Buyer to claim for any compensation.
- Any complaints regarding the Products and/or their delivery shall not be grounds for suspending or delaying the payment.
- In the event of default or risk of insolvency concerning the Buyer, the Seller will be entitled to:
 - demand payment in advance or suitable guarantees; and/or
 - suspend deliveries; and/or
 - demand immediate payment of all the invoices already issued, regardless of the payment term therein indicated; and/or
 - terminate any existing sale agreement.

4. DELIVERY

- Except as otherwise agreed upon in writing between the parties, the Seller shall deliver the Products FCA its premises (INCOTERMS latest version). If required, the Seller shall take care of the shipment of the Products at the Buyer's costs and expenses. In this last case delivery shall be considered to have taken place when the Products are transferred to the forwarder.
- In case of missing or damaged goods during transport, the Buyer must formulate all the necessary reservations on the delivery note of said goods at the time of delivery. Such reservations must also be confirmed in writing to the Seller within 48 hours of the date of the delivery, by registered mail with return receipt.
- The Seller cannot be held liable for delays in deliveries in the following circumstances:
 - acts of God or other extraordinary events beyond reasonable control, resulting in interruption of the manufacturing process, including shortage of energy and/or raw materials, pandemics strikes, embargoes or trade restrictions;
 - delays due to the Buyer, particularly when the Buyer failed to provide the information required to execute the order;
 - overdue payments, pursuant to arts. 1460 and 1461 of the Civil Code.
- Penalties for late delivery may be charged by the Buyer only when expressly agreed in a specific supply agreement, and in any case up to a maximum amount equal to the price of the delayed delivery.
- The Buyer shall not reject partial deliveries or late deliveries. All costs resulting from the rejection of goods will be charged to the Buyer. Excess deliveries for the purpose of rounding up to the packing quantity shall be deemed to be contractual performance and shall be paid by Buyer.
- Goods returned at the request of the Buyer can only be accepted if the Seller has agreed in writing. The returned parts must be in their original packaging, come from the current product range and be in saleable condition. The return shipment must be carriage paid and at the risk of the Buyer. From the purchase price to be refunded, a depreciation fee will be deducted based on the actual conditions of the goods, their age and original price. Depreciation shall not apply to goods returned under section 5 and 6 hereinafter, provided that the return was authorized by the Seller. Custom-made products or articles which are not included in the current catalogue will not be taken back. Returned goods that are not accepted by the Seller will be shipped back to Buyer or scrapped at the Buyer's choice (freight paid by the Buyer).
- In the event of modifications to the order required by the Buyer, the delivery deadline will automatically be extended for the time necessary to implement the required modification.

5. CONFORMITY

- Complaints about apparent defects or non-conformity of the product delivered in relation to the purchase order or the packing slip must be notified to the Seller in writing within 48 hours after receipt of the products, subject to forfeiture. The Buyer loses the right to claim if the goods are not inspected immediately after delivery.
- In the absence of a specific agreement on quality, the features contained in a specification, a product-specific technical data sheet or an equivalent description by the Seller shall be deemed to be the relevant quality. Insignificant deviations shall not constitute a defect.

6. WARRANTY AND LIABILITY

- Unless otherwise agreed upon in writing, the Seller warrants that the Products are free from defects in material, design and manufacturing and fit for use. No guarantee is given herein by the Seller on the conformity of any Product with the law and regulations in countries outside EU and the UK. No other warranties, express or implied, are made with respect to the Products including, but not limited to, any implied warranty of merchantability or fitness for a particular purpose.
- Unless otherwise agreed upon in writing, the warranty shall be valid for a period of one year from the date of delivery to the Buyer. Warranty is provided only on tools or machines with a serial number or other identification number that allows traceability. The warranty is, however, excluded if the Products have already been processed by the Buyer or incorporated in products, machinery or plants of the Buyer or of third parties.
- Claims for defective Products shall be made in writing within eight working days from discovery.
- The defective Products shall be returned to the Seller at the Buyer's cost upon Seller's request. The Seller's sole obligation (and Buyer's sole remedy) for any breach of warranty under the foregoing warranty shall be to repair (at location designated by Seller) or replace DAP the original point of delivery the defective goods, within a reasonable time. The Buyer will waive any claim for damage compensation once the warranty has been fulfilled and the Product has been repaired or replaced. The warranty shall not cover defects due to environmental or stress testing, misuse, failure to observe the Seller's instructions regarding the functioning, maintenance and the storage of the Products, repairs or modifications made by the Buyer or a third party without prior written authorization of the Seller, improper installation, transportation or handling.
- Direct interventions on site are not included in the warranty; if expressly requested by the Buyer they are subject to charge, according to the Seller's tariffs.
- Warranty repair/replacements may be suspended in the event of insolvency of the Buyer or overdue invoices.
- Save for the case of fraud or gross negligence, the Seller shall bear no liability for damages to property or third parties other than that expressly provided by virtue of any mandatory law provisions. In any case, the Seller shall not be liable for indirect or consequential damages of whatsoever nature as, by way of example, production losses or unearned profits. In any case, Buyer's right to damages shall be limited to a maximum amount equal to the value of the Products showing defects or faults.
- The Seller shall bear no liability for damages to property or third parties other than that expressly provided by virtue of any mandatory law provisions. The Seller will not, under any circumstances, be liable for the cost of removal or reinstallation of goods or the cost of disassembly or reassembly or for loss of business or goodwill or profits or for cost of inspection or storage or for any incidental and consequential damages of any nature which may arise from the sale of goods to the Buyer. When liability cannot be excluded by virtue of mandatory law provisions, Buyer's right to damages shall in any case be limited to a maximum amount equal to the value of the Products showing defects or faults.
- The Seller has taken out suitable insurance policies covering general liability in connection with the Products.

7. EXPORT CONTROL REGULATIONS

- CEMBRE shall not be obligated to fulfil this agreement if such fulfilment is prevented by any impediments arising out of national or international foreign trade or customs requirements or any embargoes or other sanctions or restrictions.
- If the Buyer transfers the goods to a third party, the Buyer shall comply with all applicable national and international (re-) export control regulations.
- The Buyer shall cooperate with the Seller to provide the information concerning end users, destination and intended use of goods supplied by CEMBRE, in case this is necessary due to customs control activities or export control regulations.
- Violations of this section 7 shall entitle the Seller to terminate any existing sale agreement at any time without notice.

8. INTELLECTUAL PROPERTY, CONFIDENTIALITY AND PRIVACY

- The use of CEMBRE trademarks is governed by the General Terms and Conditions, published on the website <https://www.cembre.com/group/termsandconditions>, which the Buyer is obliged to comply with. It is prohibited to relabel and repackage the Products without CEMBRE's written authorization.
- Each party will retain ownership of its Intellectual Property developed before or outside the scope of the sale agreement. If any Intellectual Property is developed under the sale agreement, the parties shall execute a separate agreement regarding the ownership thereof.
- Seller expressly reserves the copyright to its catalogues, technical documentation (e.g. drawings, plans, calculations, data sheets), other product descriptions or documents - also in electronic form. The Buyer is only granted a non-exclusive right of use.
- All drawings and technical documents relating to the Products submitted by one party to the other shall remain exclusive property of the submitting party and can only be used for the purpose for which they were provided. The receiving party is not allowed to use such documents otherwise, to procure copies thereof, to reproduce and to disclose them to a third party without consent of the submitting party. The end user of the Products shall not be deemed as a third party for the purpose of this section.
- Any liability of the Seller is excluded if the Buyer is responsible for the infringement of property rights, in particular because he has modified the object of performance, used it in breach of contract or taken it to a place other than the place of destination without the Seller's consent.
- If the Seller manufactures goods according to drawings, samples or other information provided by the Buyer (OEM products) and if the property rights of third parties are infringed in the process, the Buyer shall indemnify the Seller from all claims for damages resulting from this.
- The Seller warrants that the personal data received from the Buyer will be processed in full compliance with the applicable data protection regulations.
- Violations of this section 8 shall entitle the Seller to terminate any existing sale agreement at any time without notice.

9. APPLICABLE LAW AND JURISDICTION

- The place of performance for the delivery together with any subsequent performance on the part of the Seller is the Seller's registered office.
- Place of jurisdiction is the registered office of the Seller. The Seller is also entitled to take legal action at the Buyer's registered office.
- The legal relations between the Seller and the Buyer shall be governed by Italian law to the exclusion of the U.N. Convention on the International Sale of Goods (CISG).
- The Buyer acknowledges that the CEMBRE Group has adopted a Code of Ethics and undertakes to respect its provisions, abstaining from any unlawful conducts. Failure to comply with any of the provisions of the Code of Ethics will result in a serious breach of contractual obligations and will entitle CEMBRE to terminate the contract with immediate effect, without prejudice to compensation for damages.

10. FORCE MAJEURE AND HARDSHIP

- No failure, omission or delay of the Seller in the performance of any obligation shall be deemed a breach of the agreement nor create any liability hereunder, if the failure, omission or delay shall arise from acts of God, laws, rules, regulations or orders of any governmental authority, floods, fires, explosions, storms, earthquakes, acts of war (declared or undeclared), rebellion, insurrections, riot, sabotage, shortages of fuel, power, energy resources, and/or raw material, invasion, epidemic, quarantine, accident, strikes, lockouts, labor disputes, or any other comparable cause beyond the reasonable control of the Seller.
- If, during the term of the contract, events occur which have not been contemplated by the Parties and which fundamentally alter the equilibrium of the contract, thereby placing an excessive burden on the Seller in the performance of its contractual obligations (hardship), the Seller shall have the power to make any revision to the contract that it finds just and equitable in the circumstances, or to terminate the contract of a date and on terms to be fixed.

the Cembre group

Cembre SpA - Italy



Cembre Ltd - UK



Cembre Sarl - France



Cembre España SLU - Spain



Cembre GmbH - Germany



Cembre Inc - USA



Making the right connections

Copyright © 2022 All rights reserved.

All contents of this catalogue belong to CEMBRE S.p.A.

Any reproduction, even in part, is prohibited without prior written permission from CEMBRE.

All images are included for illustration purposes; CEMBRE reserves the right to make changes and improvements to the products without notice.

Procedures for the use of the products shown should not be inferred from this document, but from the specific use and maintenance manuals provided with the products.

Edited by CEMBRE SpA - IGB Group Press (BS), February 2022

Code 6260474

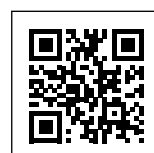

CONTACT US

FOLLOW US

CEMBRE S.p.A.
via Serenissima, 9
25135 Brescia
Italy
Ph +39 030 36921
ufficio.vendite@cembre.com
sales@cembre.com

CEMBRE Ltd.
Dunton Park,
Kingsbury Road,
Curdworth, Sutton Coldfield,
West Midlands, B76 9EB
United Kingdom
Ph +44 01675 470440
sales@cembre.co.uk

CEMBRE S.a.r.l.
22 Avenue Ferdinand
de Lesseps
91420 Morangis Cedex
France
Ph +33 01 60 49 11 90
info@cembre.fr

CEMBRE España S.L.U.
Calle Verano 6 y 8
Pl Las Manjás
28850 Torrejón de Ardoz
Madrid - Spain
Ph +34 91 4852580
comercial@cembre.com

CEMBRE GmbH
Geschäftsbereich
Energie- und Bahntechnik
Heidemannstr. 166
80939 München
Germany
Ph + 49 89-3580676
info@cembre.de

CEMBRE GmbH
Geschäftsbereich
Industrie und Handel
Boschstraße 7
71384 Weinstadt
Germany
Ph +49 7151-20536-40
info-w@cembre.de

CEMBRE Inc.
Raritan Center Business Park
300 Columbus Circle-S.F.,
Edison, NJ 08837 USA
Ph +1 (732) 225-7415
sales.us@cembre.com
Midwest Office
1051 Perimeter Dr #610
Schaumburg, IL 60173